



# The Future of Coal

AN INTERDISCIPLINARY MIT STUDY

# The Future of Coal

OPTIONS FOR A  
CARBON-CONSTRAINED WORLD

Copyright © 2007 Massachusetts Institute of Technology. All rights reserved.

ISBN 978-0-615-14092-6

# Study Participants

**PROFESSOR STEPHEN ANSOLABEHERE**

Department of Political Science, MIT

**PROFESSOR JANOS BEER**

Department of Chemical Engineering, MIT

**PROFESSOR JOHN DEUTCH – CO-CHAIR**

Institute Professor

Department of Chemistry, MIT

**DR. A. DENNY ELLERMAN**

Alfred P. Sloan School of Management, MIT

**DR. S. JULIO FRIEDMANN**

Visiting Scientist, Laboratory for Energy and the Environment, MIT

Carbon Management Program

Energy & Environment Directorate

Lawrence Livermore National Laboratory

**HOWARD HERZOG**

Laboratory for Energy and the Environment, MIT

**PROFESSOR HENRY D. JACOBY**

Alfred P. Sloan School of Management, MIT

**PROFESSOR PAUL L. JOSKOW**

Elizabeth and James Killian Professor of Economics and Management

Department of Economics and Alfred P. Sloan School of Management, MIT

Director, Center for Energy and Environmental Policy Research

**PROFESSOR GREGORY MCRAE**

Department of Chemical Engineering, MIT

**PROFESSOR RICHARD LESTER**

Director, Industrial Performance Center

Department of Nuclear Engineering, MIT

**PROFESSOR ERNEST J. MONIZ – CO-CHAIR**

Cecil and Ida Green Professor of Physics and Engineering Systems

Department of Physics, MIT

Director, Laboratory for Energy and the Environment

**PROFESSOR EDWARD STEINFELD**

Department of Political Science, MIT

**DR. JAMES KATZER**

*Executive Director*

# MIT Coal Energy Study Advisory Committee Members

**PHILIP SHARP**

President, Resources for the Future

**JOSEPH CHAISSON**

Research & Technical Director, Clean Air Taskforce

**EILEEN CLAUSSEN**

President, Pew Center on Global Climate Change

**TED GREENWOOD**

Program Director, Alfred P. Sloan Foundation

**DAVID HAWKINS**

Natural Resources Defense Council

**JEFF MILLER**

Tremont Group

**JOHN PODESTA**

President & CEO, Center for American Progress

**BASEM SARANDAH**

President & CEO, Nexant

**ADEL SAROFIM**

Presidential Professor, Department of Chemical Engineering  
Institute for Combustion and Energy Studies  
University of Utah

**LINDA STUNTZ**

Partner, Stuntz, Davis, & Staffier, P.C.

**JOHN SUNUNU**

JHS Associates, Ltd.

**KURT YEAGER**

President & CEO, Emeritus, Electric Power Research Institute (EPRI)

---

Members did not approve or endorse the report and individual members of the advisory committee have different views on one or more of matters addressed in this report

# Table of Contents

Chapter 1	Purpose of the Study	1
Chapter 2	The Role of Coal in Energy Growth and CO <sub>2</sub> Emissions	5
Chapter 3	Coal-based Electricity Generation	17
Chapter 4	Geological Carbon Sequestration	43
Chapter 5	Coal Consumption in China and India	63
Chapter 6	Analysis, Research, Development, and Demonstration	77
Chapter 7	Public Attitudes toward Energy, Global Warming, and Carbon Taxes	89
Chapter 8	Findings and Recommendations	95

	Glossary of Technical Terms and Abbreviations	107
--	---	-----

## APPENDICES

### Appendices to Chapter 3:

<i>A. Coal Quality</i>	109
<i>B. Electricity Generation Primer</i>	114
<i>C. Electricity Generation Economics: Bases and Assumptions</i>	127
<i>D. U.S. Emissions Regulations and Emissions Performance</i>	135
<i>E. Retrofitting Existing Units for CO<sub>2</sub> Capture</i>	145
<i>F. Coal to Fuels and Chemicals</i>	153

### Appendices to Chapter 4:

<i>A. Unconventional CO<sub>2</sub> Storage Targets</i>	159
<i>B. Well Abandonment Practices Relevant to CO<sub>2</sub> Sequestration</i>	161
<i>C. Description and Cost Assumptions for CO<sub>2</sub> Storage Projects</i>	165

	Appendix to Chapter 5: India	167
--	------------------------------	-----

	Appendix to Chapter 8: Government Assistance to IGCC Plants without Capture	173
--	---	-----



# Foreword

In 2002, a group of MIT Faculty decided to undertake a series of interdisciplinary studies about how the United States and the world would meet future energy demand without increasing emissions of carbon dioxide (CO<sub>2</sub>) or other greenhouse gases. The first study “The Future of Nuclear Power” appeared in 2003. In 2004 a similar group of MIT faculty undertook the present study, “The Future of Coal.” The purpose of the study is to examine the role of coal in a world where constraints on carbon emissions are adopted to mitigate global warming. The study’s particular emphasis is to compare the performance and cost of different coal combustion technologies when combined with an integrated system for CO<sub>2</sub> capture and sequestration.

Our audience is government, industry and academic leaders and decision makers interested

in the management of the interrelated set of technical, economic, environmental, and political issues that must be addressed in seeking to limit and to reduce greenhouse gas emissions to mitigate the effects of climate change. Coal is likely to remain an important source of energy in any conceivable future energy scenario. Accordingly, our study focuses on identifying the priority actions needed to reduce the CO<sub>2</sub> emissions that coal use produces. We trust that our integrated analysis will stimulate constructive dialogue both in the United States and throughout the world.

This study reflects our conviction that the MIT community is well equipped to carry out interdisciplinary studies of this nature to shed light on complex socio-technical issues that will have major impact on our economy and society.



# Acknowledgments

This study is better as a result of comments and suggestions of members of the advisory committee, and we are especially grateful for their participation. It should be understood, however, that the study is the responsibility of the MIT participants; the advisory committee was not asked to approve or endorse the study and indeed individual advisory committee members may have differing views on many subjects that were addressed.

Our study benefited greatly from the participation of a number of graduate student research assistants, notably,

Mark Bohm,

Edward Cunningham,

Salem Esber,

James R. McFarland,

Mark de Figueiredo,

Jeremy Johnson,

Ayaka Naga-Jones,

Mudit Narain

Ram Sekar

Lori Simpson,

Manuela Ueda, and

Ola Maurstad, post doctoral research associate.

In addition, during the course of the Coal Study two successive classes of MIT undergraduate seniors participated in the Chemical Engineering Senior Design Subject, 10.491. Each year, approximately 60 students were assigned in teams of 4 to analyze and design solutions to component parts of the CO<sub>2</sub> capture system. The final reports from the teams and the efforts of the course's teaching assistants led to important contributions to this study:

Stanislas Bailly,

Brendan Blackwell,

Salem Ebser,

Chuang-Chung Lee,

Andrei Maces, and

Katherina Wilkins.

Generous financial support from the Alfred P. Sloan Foundation, the Pew Charitable Trusts, the Energy Foundation, the Better World Fund, Norwegian Research Council, and the MIT Office of the Provost is gratefully acknowledged. Shell provided additional support for part of our studies in China.

# Executive Summary

**This MIT study examines the role of coal as an energy source in a world where constraints on carbon emissions are adopted to mitigate global warming.** Our first premise is that the risks of global warming are real and that the United States and other governments should and will take action to restrict the emission of CO<sub>2</sub> and other greenhouse gases. Our second and equally important premise is that coal will continue to play a large and indispensable role in a greenhouse gas constrained world. Indeed, the challenge for governments and industry is to find a path that mitigates carbon emissions yet continues to utilize coal to meet urgent energy needs, especially in developing economies. The scale of the enterprise is vast. (See Box 1).

**Our purpose is to identify the measures that should be taken to assure the availability of demonstrated technologies that would facilitate the achievement of carbon emission reduction goals,** while continuing to rely on coal to meet a significant fraction of the world's energy needs. Our study has not analyzed alternative carbon emission control policies and accordingly the study does not make recommendations on what carbon mitigation measure should be adopted today. Nevertheless, our hope is that the study will contribute to prompt adoption of a comprehensive U.S. policy on carbon emissions.

**We believe that coal use will increase under any foreseeable scenario because it is cheap and abundant.** Coal can provide usable energy at a cost of between \$1 and \$2 per MMBtu compared to \$6 to \$12 per MMBtu for oil and natural gas. Moreover, coal resources are distributed in regions of the world other than the Persian Gulf, the unstable region that contains the larg-

## BOX 1 ILLUSTRATING THE CHALLENGE OF SCALE FOR CARBON CAPTURE

- Today fossil sources account for 80% of energy demand: Coal (25%), natural gas (21%), petroleum (34%), nuclear (6.5%), hydro (2.2%), and biomass and waste (11%). Only 0.4% of global energy demand is met by geothermal, solar and wind.<sup>1</sup>
- 50% of the electricity generated in the U.S. is from coal.<sup>2</sup>
- There are the equivalent of more than five hundred, 500 megawatt, coal-fired power plants in the United States with an average age of 35 years.<sup>2</sup>
- China is currently constructing the equivalent of two, 500 megawatt, coal-fired power plants per week and a capacity comparable to the entire UK power grid each year.<sup>3</sup>
- One 500 megawatt coal-fired power plant produces approximately 3 million tons/year of carbon dioxide (CO<sub>2</sub>).<sup>3</sup>
- The United States produces about 1.5 billion tons per year of CO<sub>2</sub> from coal-burning power plants.
- If all of this CO<sub>2</sub> is transported for sequestration, the quantity is equivalent to three times the weight and, under typical operating conditions, one-third of the annual volume of natural gas transported by the U.S. gas pipeline system.
- If 60% of the CO<sub>2</sub> produced from U.S. coal-based power generation were to be captured and compressed to a liquid for geologic sequestration, its volume would about equal the total U.S. oil consumption of 20 million barrels per day.
- At present the largest sequestration project is injecting one million tons/year of carbon dioxide (CO<sub>2</sub>) from the Sleipner gas field into a saline aquifer under the North Sea.<sup>3</sup>

### Notes

1. IEA Key World Energy Statistics (2006)
2. EIA 2005 annual statistics ([www.eia.doe.gov](http://www.eia.doe.gov))
3. Derived from the MIT Coal Study

est reserves of oil and gas. In particular the United States, China and India have immense coal reserves. For them, as well as for importers of coal in Europe and East Asia, economics and security of supply are significant incentives for the continuing use of coal. Carbon-free technologies, chiefly nuclear and renewable energy for electricity, will also play an important role in a carbon-constrained world, but absent a technological breakthrough that we do not foresee, coal, in significant quantities, will remain indispensable.

However, coal also can have significant adverse environmental impacts in its production and use. Over the past two decades major progress has been made in reducing the emissions of so-called “criteria” air pollutants: sulfur oxides, nitrogen oxides, and particulates from coal combustion plants, and regulations have recently been put into place to reduce mercury emissions. Our focus in this study is on approaches for controlling CO<sub>2</sub> emissions. These emissions are relatively large per Btu of heat energy produced by coal because of its high carbon content.

**We conclude that CO<sub>2</sub> capture and sequestration (CCS) is the critical enabling technology that would reduce CO<sub>2</sub> emissions significantly while also allowing coal to meet the world’s pressing energy needs.**

*1. This carbon charge may take the form of a direct tax, a price imposed by a cap-and-trade mechanism, or some other type of regulatory constraint on CO<sub>2</sub> emissions. We shall refer to this charge as a tax, price, penalty, or constraint interchangeably throughout this report and the use of one form or another should not be taken as an indication of a preference for that form unless so stated.*

To explore this prospect, our study employs the *Emissions Predictions and Policy Analysis* (EPPA) model, developed at MIT, to prepare scenarios of global coal use and CO<sub>2</sub> emissions under various assumptions about the level and timing of the carbon charge<sup>1</sup> that might be imposed on CO<sub>2</sub> emissions and the cost of removing CO<sub>2</sub> from coal. The response of the global economy to placing a price on CO<sub>2</sub> emissions is manifold: less energy is used, there is switching to lower carbon fuels, the efficiency of new and existing power plants is improved, and new carbon control technologies are introduced, for example CCS. In characterizing the CO<sub>2</sub> emission price, we employ a “high” price trajectory that starts at \$25/tonne-CO<sub>2</sub> in 2015 and increases thereafter at a real rate of 4% per year. The \$25 per tonne price is significant because it approaches the level that makes CCS technology economic.

We also examine a “low” price trajectory that begins with a CO<sub>2</sub> emission price of \$7/tonne in 2010 and increases at a rate of 5% thereafter. The key characteristic of the “low” price is that it reaches the initial “high” price level nearly 25 years later. Other assumptions studied include the development of nuclear power to 2050 (limited or expanded) and the profile of natural gas prices (as calculated by the model or at a lower level).

Our conclusion is that coal will continue to be used to meet the world’s energy needs in significant quantities. The high CO<sub>2</sub>-price scenario leads to a substantial reduction in coal use in 2050 relative to “business as usual” (BAU), but still with increased coal use relative to 2000 in most cases. In such a carbon-constrained world, CCS is the critical future technology option for reducing CO<sub>2</sub> emissions while keeping coal use above today’s level. Table 1 shows the case with higher CO<sub>2</sub> prices and applying the EPPA model’s reference projection for natural gas prices. The availability of CCS makes a significant difference in the utilization of coal at mid-century regardless of the level of the CO<sub>2</sub> prices (not shown in the table) or the assumption about nuclear power growth. With CCS more coal is used in 2050 than today, while global CO<sub>2</sub> emissions from all sources of energy are only slightly higher than today’s level and less than half of the BAU level. A major contributor to the global emissions reduction for 2050 is the reduction in CO<sub>2</sub> emissions from coal to half or less of today’s level and to one-sixth or less that in the BAU projection.

**Table 1 Exajoules of Coal Use (EJ) and Global CO<sub>2</sub> Emissions (Gt/yr) in 2000 and 2050 with and without Carbon Capture and Storage\***

	BUSINESS AS USUAL		LIMITED NUCLEAR 2050		EXPANDED NUCLEAR 2050	
	2000	2050	WITH CCS	WITHOUT CCS	WITH CCS	WITHOUT CCS
	Coal Use: Global	100	448	161	116	121
<i>U.S.</i>	24	58	40	28	25	13
<i>China</i>	27	88	39	24	31	17
Global CO <sub>2</sub> Emissions	24	62	28	32	26	29
CO <sub>2</sub> Emissions from Coal	9	32	5	9	3	6

*\* Universal, simultaneous participation, High CO<sub>2</sub> prices and EPPA-Ref gas prices.*

The “low” CO<sub>2</sub> price scenario reaches the level where CCS becomes economic some 25 years later than under the higher price case. As a result coal consumption is higher in 2050 relative to the high CO<sub>2</sub> price scenario and, in addition, the contribution of CCS is much lower, thus leading to substantially higher CO<sub>2</sub> emissions.

Today, and independent of whatever carbon constraints may be chosen, **the priority objective with respect to coal should be the successful large-scale demonstration of the technical, economic, and environmental performance of the technologies that make up all of the major components of a large-scale integrated CCS system — capture, transportation and storage.** Such demonstrations are a prerequisite for broad deployment at gigatonne scale in response to the adoption of a future carbon mitigation policy, as well as for easing the trade-off between restraining emissions from fossil resource use and meeting the world’s future energy needs

**Successful implementation of CCS will inevitably add cost for coal combustion and conversion.** We estimate that for new plant construction, a CO<sub>2</sub> emission price of approximately \$30/tonne (about \$110/tonne C) would make CCS cost competitive with coal combustion and conversion systems without CCS. This would be sufficient to offset the cost of CO<sub>2</sub> capture and pressurization (about \$25/tonne) and CO<sub>2</sub> transportation and storage (about \$5/tonne). This estimate of CCS cost is uncertain; it might be larger and with new technology, perhaps smaller.

The pace of deployment of coal-fired power plants with CCS depends both on the timing and level of CO<sub>2</sub> emission prices and on the technical readiness and successful commercial demonstration of CCS technologies. The timing and the level of CO<sub>2</sub> emission prices is uncertain. However, there should be no delay in undertaking a program that would establish the option to utilize CCS at large scale in response to a carbon emission control policy that would make CCS technology economic. Sequestration rates of one to two gigatonnes of carbon (nearly four to eight gigatonnes of CO<sub>2</sub>) per year by mid-century will enable appreciably enhanced coal use and significantly reduced CO<sub>2</sub> emissions.

**What is needed is to demonstrate an integrated system of capture, transportation, and storage of CO<sub>2</sub>, at scale.** This is a practical goal but requires concerted action to carry out. The integrated demonstration must include a properly instrumented storage site that operates under a regulatory framework which includes site selection, injection and surveillance,

and conditions for eventual transfer of liability to the government after a period of good practice is demonstrated.

**An explicit and rigorous regulatory process that has public and political support is prerequisite for implementation of carbon sequestration on a large scale.** This regulatory process must resolve issues associated with the definition of property rights, liability, site licensing and monitoring, ownership, compensation arrangements and other institutional and legal considerations. Regulatory **protocols need to be defined for sequestration projects including site selection, injection operation, and eventual transfer of custody to public authorities after a period of successful operation.** In addition to constraints of CO<sub>2</sub> emissions, the pacing issues for the adoption of CCS technology in a greenhouse gas constrained world are resolution of the scientific, engineering, and regulatory issues involved in large-scale sequestration in relevant geologies. These issues should be addressed with far more urgency than is evidenced today.

**At present government and private sector programs to implement on a timely basis the required large-scale integrated demonstrations to confirm the suitability of carbon sequestration are completely inadequate.** If this deficiency is not remedied, the United States and other governments may find that they are prevented from implementing certain carbon control policies because the necessary work to regulate responsibly carbon sequestration has not been done. **Thus, we believe high priority should be given to a program that will demonstrate CO<sub>2</sub> sequestration at a scale of 1 million tonnes CO<sub>2</sub> per year in several geologies.**

We have confidence that large-scale CO<sub>2</sub> injection projects can be operated safely, however no CO<sub>2</sub> storage project that is currently operating (Sleipner, Norway; Weyburn, Canada; In Salah, Algeria) has the necessary modeling, monitoring, and verification (MMV) capability to resolve outstanding technical issues, at scale. Each reservoir for large-scale sequestration will have unique characteristics that demand site-specific study, and a range of geologies should be investigated. We estimate that the number of at-scale CCS projects needed is about 3 in the U.S. and about 10 worldwide to cover the range of likely accessible geologies for large scale storage. Data from each project should be thoroughly analyzed and shared. The cost per project (not including acquisition of CO<sub>2</sub>) is about \$15 million/year for a ten-year period.

CO<sub>2</sub> injection projects for enhanced oil recovery (EOR) have limited significance for long-term, large-scale CO<sub>2</sub> sequestration — regulations differ, the capacity of EOR projects is inadequate for large-scale deployment, the geological formation has been disrupted by production, and EOR projects are usually not well instrumented. The scale of CCS required to make a major difference in global greenhouse gas concentrations is massive. For example, sequestering one gigatonne of carbon per year (nearly four gigatonnes of carbon dioxide) requires injection of about fifty million barrels per day of supercritical CO<sub>2</sub> from about 600 1000MW<sub>e</sub> of coal plants.

While a rigorous CO<sub>2</sub> sequestration demonstration program is a vital underpinning to extended CCS deployment that we consider a necessary part of a comprehensive carbon emission control policy, we emphasize there is no reason to delay prompt adoption of U.S. carbon emission control policy until the sequestration demonstration program is completed.

**A second high-priority requirement is to demonstrate CO<sub>2</sub> capture for several alternative coal combustion and conversion technologies.** At present Integrated Gasification Combined Cycle (IGCC) is the leading candidate for electricity production with CO<sub>2</sub> capture because it is estimated to have lower cost than pulverized coal with capture; however, neither IGCC nor other coal technologies have been demonstrated with CCS. **It is critical that the government RD&D program not fall into the trap of picking a technology “winner,”** especially at a time when there is great coal combustion and conversion development activity underway in the private sector in both the United States and abroad.

Approaches with capture other than IGCC could prove as attractive with further technology development for example, oxygen fired pulverized coal combustion, especially with lower quality coals. Of course, there will be improvements in IGCC as well. R&D is needed on sub-systems, for example on improved CO<sub>2</sub> separation techniques for both oxygen and air driven product gases and for oxygen separation from air. The technology program would benefit from an extensive modeling and simulation effort in order to compare alternative technologies and integrated systems as well as to guide development. Novel separation schemes such as chemical looping should continue to be pursued at the process development unit (PDU) scale. The reality is that the diversity of coal type, e.g. heat, sulfur, water, and ash content, imply different operating conditions for any application and multiple technologies will likely be deployed.

**Government support will be needed for these demonstration projects as well as for the supporting R&D program.** Government assistance is needed and should be provided to demonstrate the technical performance and cost of coal technologies with CCS, including notably IGCC. There is no operational experience with carbon capture from coal plants and certainly not with an integrated sequestration operation. Given the technical uncertainty and the current absence of a carbon charge, there is no economic incentive for private firms to undertake such projects. Energy companies have advanced a number of major projects and all have made clear the need for government assistance in order to proceed with unproved “carbon-free” technology.

The U.S 2005 Energy Act contains provisions that authorize federal government assistance for IGCC or pulverized coal plants containing advanced technology projects with or without CCS. We believe that this assistance should be directed only to plants with CCS, both new plants and retrofit applications on existing plants. Many electric utilities and power plant developers who are proposing new coal-fired electricity generating units are choosing super-critical pulverized coal units because in the absence of charges on CO<sub>2</sub> emissions, the bus bar cost of generating electricity (COE) from pulverized coal (PC) power plants is lower than IGCC and its availability is higher. These prospective new plants, as well as the existing stock of coal-fired power plants, raise the issue of the future retrofit of coal-fired power plants that are in existence at the time when a carbon charge is imposed. This problem is distinct from that of the technology to be chosen for the new power plants that will be built after a carbon charge has been imposed. Pending adoption of policies to limit CO<sub>2</sub> emissions, if federal assistance is extended to coal projects, it should be limited to projects that employ CCS.

It has been argued that the prospect of a future carbon charge should create a preference for the technology that has the lowest cost of retrofit for CO<sub>2</sub> capture and storage, or that power plants built now should be “capture-ready,” which is often interpreted to mean that new coal-fired power plants should be IGCC only.

From the standpoint of a power plant developer, the choice of a coal-fired technology for a new power plant today involves a delicate balancing of considerations. On the one hand, factors such as the potential tightening of air quality standards for SO<sub>2</sub>, NO<sub>x</sub>, and mercury, a future carbon charge, or the possible introduction of federal or state financial assistance for IGCC would seem to favor the choice of IGCC. On the other hand, factors such as near-term opportunity for higher efficiency, capability to use lower cost coals, the ability to cycle the power plant more readily in response to grid conditions, and confidence in reaching capacity factor/efficiency performance goals would seem to favor the choice of supercritical pulverized coal<sup>2</sup> (SCPC). Other than recommending that new coal units should be built with the highest efficiency that is economically justifiable, we do not believe that a clear preference for either technology can be justified.

*2. Pulverized coal plants can be subcritical (SubCPC), supercritical (SCPC) or ultra-supercritical (USCPC). For simplicity, we refer to the latter two as SCPC except when, as in Chapter 3, a specific comparison is made. There is no clear dividing line between SCPC and USCPC.*

**Moreover, retrofitting an existing coal-fired plant originally designed to operate without carbon capture will require major technical modification**, regardless of whether the technology is SCPC or IGCC. The retrofit will go well beyond the addition of an “in-line” process unit to capture the CO<sub>2</sub>; all process conditions will be changed which, in turn, implies the need for changes to turbines, heat rate, gas clean-up systems, and other process units for efficient operation. Based on today’s engineering estimates, the cost of retrofitting an IGCC plant, originally designed to operate without CCS so as to capture a significant fraction of emitted carbon, appears to be cheaper than the retrofit cost of a SCPC plant. However, this characteristic of IGCC has not been demonstrated.” Also, even if the retrofit cost of an IGCC plant is cheaper, the difference in the net present value of an IGCC and SCPC plant built now and retrofitted later in response to a future carbon charge depends heavily on the estimate of the timing and size of a carbon charge, as well as the difference in retrofit cost. Essentially, there is a trade-off between cheaper electricity prior to the carbon charge and higher cost later.

Opportunity to build “capture ready” features into new coal plants, regardless of technology, are limited. Other than simple modification to plant layout to leave space for retrofit equipment such as shift reactors, **pre-investment in “capture ready” features for IGCC or pulverized coal combustion plants designed to operate initially without CCS is unlikely to be economically attractive**. It would be cheaper to build a lower capital cost plant without capture and later either to pay the price placed on carbon emissions or make the incremental investment in retrofitting for carbon capture when justified by a carbon price. However, there is little engineering analysis or data to explore the range of pre-investment options that might be considered.

**There is the possibility of a perverse incentive for increased early investment in coal-fired power plants without capture, whether SCPC or IGCC, in the expectation that the emissions from these plants would potentially be “grandfathered” by the grant of free CO<sub>2</sub> allowances as part of future carbon emissions regulations** and that (in unregulated markets) they would also benefit from the increase in electricity prices that will accompany a carbon control regime. Congress should act to close this “grandfathering” loophole before it becomes a problem.

The DOE Clean Coal program is not on a path to address our priority recommendations because the level of funding falls far short of what is required and the program content is not aligned with our strategic objectives. The flagship DOE project, FutureGen, is consistent with our priority recommendation to initiate integrated demonstration projects at scale. However, we have some concerns about this particular project, specifically the need

to clarify better the project objectives (research vs. demonstration), the inclusion of international partners that may further muddle the objectives, and whether political realities will allow the FutureGen consortium the freedom to operate this project in a manner that will inform private sector investment decisions.

Responsibility for the integrated CCS demonstration projects, including acquisition of the CO<sub>2</sub> needed for the sequestration demonstration, should be assigned to a new quasi-government Carbon Sequestration Demonstration Corporation. The corporation should select the demonstration projects and should provide financial assistance that will permit industry to manage the projects in as commercial a manner as possible.

**Success at capping CO<sub>2</sub> emissions ultimately depends upon adherence to CO<sub>2</sub> mitigation policies by large developed and developing economies.** We see little progress to moving toward the needed international arrangements. Although the European Union has implemented a cap-and-trade program covering approximately half of its CO<sub>2</sub> emissions, the United States has not yet adopted mandatory policies at the federal level to limit CO<sub>2</sub> emissions. U.S. leadership in emissions reduction is a likely pre-requisite to substantial action by emerging economies.

A more aggressive U.S. policy appears to be in line with public attitudes. Americans now rank global warming as the number one environmental problem facing the country, and seventy percent of the American public think that the U.S. government needs to do more to reduce greenhouse gas emissions. Willingness to pay to solve this problem has grown 50 percent over the past three years.

Examination of current energy developments in China and India, however, indicate that it will be some time before carbon constraints will be adopted and implemented by China. The same is likely true for India.

An international system with modestly delayed compliance by emerging economies is manageable from the point of view of incremental accumulated CO<sub>2</sub> emissions. However, if other nations, and especially China and India, are to deal with this problem then CCS is a crucial technology for these countries as well, and the R&D and commercial demonstration focus proposed here is no less important in readying CCS for quick adoption if and when they begin to take more stringent control measures.

*The central message of our study is that demonstration of technical, economic, and institutional features of carbon capture and sequestration at commercial scale coal combustion and conversion plants, will (1) give policymakers and the public confidence that a practical carbon mitigation control option exists, (2) shorten the deployment time and reduce the cost for carbon capture and sequestration should a carbon emission control policy be adopted, and (3) maintain opportunities for the lowest cost and most widely available energy form to be used to meet the world's pressing energy needs in an environmentally acceptable manner.*



# Chapter 1 – Purpose of the Study

The risk of adverse climate change from global warming forced in part by growing greenhouse gas emissions is serious. While projections vary, there is now wide acceptance among the scientific community that global warming is occurring, that the human contribution is important, and that the effects may impose significant costs on the world economy. As a result, governments are likely to adopt carbon mitigation policies that will restrict CO<sub>2</sub> emissions; many developed countries have taken the first steps in this direction. For such carbon control policies to work efficiently, national economies will need to have many options available for reducing greenhouse gas emissions. As our earlier study — *The Future of Nuclear Power* — concluded, the solution lies not in a single technology but in more effective use of existing fuels and technologies, as well as wider adoption of alternative energy sources. This study — *The Future of Coal* — addresses one option, the continuing use of coal with reduced CO<sub>2</sub> emissions.

Coal is an especially crucial fuel in this uncertain world of future constraint on CO<sub>2</sub> emissions. Because coal is abundant and relatively cheap — \$1–2 per million Btu, compared to \$ 6–12 per million Btu for natural gas and oil — today, coal is often the fuel of choice for electricity generation and perhaps for extensive synthetic liquids production in the future in many parts of the world. Its low cost and wide availability make it especially attractive in major developing economies for meeting their pressing energy needs. On the other hand, coal faces significant environmental challenges in mining, air pollution (including both criteria pollutants and mercury), and

importantly from the perspective of this study, emission of carbon dioxide (CO<sub>2</sub>). Indeed coal is the largest contributor to global CO<sub>2</sub> emissions from energy use (41%), and its share is projected to increase.

This study examines the factors that will affect the use of coal in a world where significant constraints are placed on emissions of CO<sub>2</sub> and other greenhouse gases. We explore how the use of coal might adjust within the overall context of changes in the demand for and supply of different fuels that occur when energy markets respond to policies that impose a significant constraint on CO<sub>2</sub> emissions. Our purpose is to describe the technology options that are currently and potentially available for coal use in the generation of electricity if carbon constraints are adopted. In particular, we focus on **carbon capture and sequestration (CCS)** — the separation of the CO<sub>2</sub> combustion product that is produced in conjunction with the generation of electricity from coal and the transportation of the separated CO<sub>2</sub> to a site where the CO<sub>2</sub> is sequestered from the atmosphere. Carbon capture and sequestration add significant complexity and cost to coal conversion processes and, if deployed at large scale, will require considerable modification to current patterns of coal use.

We also describe the research, development, and demonstration (RD&D) that should be underway today, if these technology options are to be available for rapid deployment in the future, should the United States and other countries adopt carbon constraint policies. Our recommendations are restricted to what needs to be done to establish these technology

options to create viable choices for future coal use.

Our study does not address climate policy, nor does it evaluate or advocate any particular set of carbon mitigation policies. Many qualified groups have offered proposals and analysis about what policy measures might be adopted. We choose to focus on what is needed to create technology options with predictable performance and cost characteristics, if such policies are adopted. If technology preparation is not done today, policy-makers in the future will be faced with fewer and more difficult choices in responding to climate change.

We are also realistic about the process of adoption of technologies around the world. This is a global problem, and the ability to embrace a new technology pathway will be driven by the industrial structure and politics in the developed and developing worlds. In this regard, we offer assessments of technology adoption in China and India and of public recognition and concern about this problem in the United States.

The overarching goal of this series of MIT energy studies is to identify different combinations of policy measures and technical innovations that will reduce global emissions of CO<sub>2</sub> and other greenhouse gases by mid-century. The present study on *The future of coal* and the previous study on *The future of nuclear power* discuss two of the most important possibilities.

An outline of this study follows:

**Chapter 2** presents a framework for examining the range of global coal use in all energy-using sectors out to 2050 under alternative economic assumptions. These projections are based on the MIT Emissions Predictions and Policy Analysis (EPPA) model. The results sharpen understanding of how a system of global markets for energy, intermediate inputs, and final goods and services would respond to imposition of a carbon charge (which could take the form of a carbon emissions tax, a cap and trade program, or other constraints that place

a de facto price on carbon emissions) through reduced energy use, improvements in energy efficiency, switching to lower CO<sub>2</sub>-emitting fuels or carbon-free energy sources, and the introduction of CCS.

**Chapter 3** is devoted to examining the technical and likely economic performance of alternative technologies for generating electricity with coal with and without carbon capture and sequestration in both new plant and retrofit applications. We analyze air and oxygen driven pulverized coal, fluidized bed, and IGCC technologies for electricity production. Our estimates for the technical and environmental performance and for likely production cost are based on today's experience.

**Chapter 4** presents a comprehensive review of what is needed to establish CO<sub>2</sub> sequestration as a reliable option. Particular emphasis is placed on the need for geological surveys, which will map the location and capacity of possible deep saline aquifers for CO<sub>2</sub> injection in the United States and around the world, and for demonstrations at scale, which will help establish the regulatory framework for selecting sites, for measurement, monitoring and verification systems, and for long-term stewardship of the sequestered CO<sub>2</sub>. These regulatory aspects will be important factors in gaining public acceptance for geological CO<sub>2</sub> storage.

**Chapter 5** reports on the outlook for coal production and utilization in China and India. Most of our effort was devoted to China. China's coal output is double that of the United States, and its use of coal is rapidly growing, especially in the electric power sector. Our analysis of the Chinese power sector examines the roles of central, provincial, and local actors in investment and operational decisions affecting the use of coal and its environmental impacts. It points to a set of practical constraints on the ability of the central government to implement restrictions on CO<sub>2</sub> emissions in the relatively near-term.

**Chapter 6** evaluates the current DOE RD&D program as it relates to the key issues discussed

in Chapters 2, 3, and 4. It also makes recommendations with respect to the content and organization of federally funded RD&D that would provide greater assurance that CC&S would be available when needed.

**Chapter 7** reports the results of polling that we have conducted over the years concerning public attitudes towards energy, global warming and carbon taxes. There is evidence that public attitudes are shifting and that support for policies that would constrain CO<sub>2</sub> emissions is increasing.

**Chapter 8** summarizes the findings and presents the conclusions of our study and offers recommendations for making coal use with significantly reduced CO<sub>2</sub> emissions a realistic option in a carbon constrained world.

The reader will find technical primers and additional background information in the appendices to the report.



# Chapter 2 — The Role of Coal in Energy Growth and CO<sub>2</sub> Emissions

## INTRODUCTION

There are five broad options for reducing carbon emissions from the combustion of fossil fuels, which is the major contributor to the anthropogenic greenhouse effect:

- Improvements in the efficiency of energy use, importantly including transportation, and electricity generation;
- Increased use of renewable energy such as wind, solar and biomass;
- Expanded electricity production from nuclear energy;
- Switching to less carbon-intensive fossil fuels; and
- Continued combustion of fossil fuels, especially coal, combined with CO<sub>2</sub> capture and storage (CCS).

As stressed in an earlier MIT study of the nuclear option,<sup>1</sup> if additional CO<sub>2</sub> policies are adopted, it is not likely that any one path to emissions reduction will emerge. All will play a role in proportions that are impossible to predict today. This study focuses on coal and on measures that can be taken now to facilitate the use of this valuable fuel in a carbon-constrained world. The purpose of this chapter is to provide an overview of the possible CO<sub>2</sub> emissions from coal burning over the next 45 years and to set a context for assessing policies that will contribute to the technology advance that will be needed if carbon emissions from coal combustion are to be reduced.

Coal is certain to play a major role in the world's energy future for two reasons. First, it

is the lowest-cost fossil source for base-load electricity generation, even taking account of the fact that the capital cost of a supercritical pulverized coal combustion plant (SCPC) is about twice that of a natural gas combined cycle (NGCC) unit. And second, in contrast to oil and natural gas, coal resources are widely distributed around the world. As shown in Figure 2.1, drawn from U.S. DOE statistics,<sup>2</sup> coal reserves are spread between developed and developing countries.

The major disadvantages of coal come from the adverse environmental effects that accompany its mining, transport and combustion. Coal combustion results in greater CO<sub>2</sub> emissions than oil and natural gas per unit of heat output because of its relatively higher ratio of carbon to hydrogen and because the efficiency (i.e., heat rate) of a NGCC plant is higher than that of a SCPC plant. In addition to CO<sub>2</sub>, the combustion-related emissions of coal generation include the criteria pollutants: sulfur dioxide (SO<sub>2</sub>), nitrogen oxides (NO and NO<sub>2</sub>,

**Figure 2.1 Recoverable Coal Reserves**

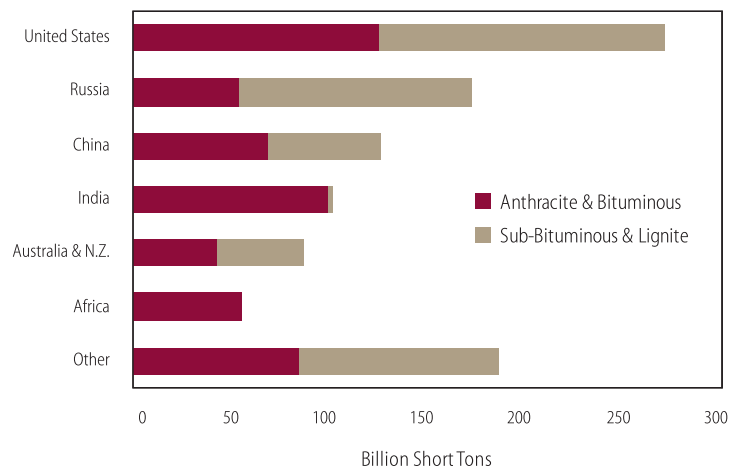

**Table 2.1 2004 Characteristics of World Coals**

	PRODUCTION (Million Short Tons)	AVERAGE HEAT CONTENT (Thousand Btu/Short Ton)
US	1,110	20,400
Australia	391	20,300
Russia	309	19,000
South Africa	268	21,300
India	444	16,400
China	2,156	19,900

Source: DOE/EIA IEA (2006), Tables 2.5 and C.6

**Table 2.2 Coal Use Projections and Average Rate of Increase 2002–2030**

	2003	2010	2015	2020	2025	2030	AV. % INCREASE
<b>US</b>							
Total (Quadrillion Btu)	22.4	25.1	25.7	27.6	30.9	34.5	1.6
% Electric	90	91	91	91	91	89	1.6
<b>China</b>							
Total (Quadrillion Btu)	29.5	48.8	56.6	67.9	77.8	89.4	4.2
% Electric	55	55	57	55	56	56	4.2

Source: EIA/EIA IEO (2006), Tables D1 and D9.

jointly referred to as NO<sub>x</sub>), particulates, and mercury (Hg). Also, there are other aspects of coal and its use not addressed in this study. For example,

**Coal is not a single material.** Coal composition, structure, and properties differ considerably among mining locations. Table 2.1, also drawn from DOE data,<sup>3</sup> shows the wide variation of energy content in the coals produced in different countries. These differences are a consequence of variation in chemical composition—notably water and ash content—which has an important influence on the selection of coal combustion technology and equipment. This point is discussed further in Chapter 3.

**Coal mining involves considerable environmental costs.** The environmental effects of mining include water pollution and land disturbance as well as the release of another green-

house gas, methane (CH<sub>4</sub>), which is entrained in the coal. Also, mining involves significant risk to the health and safety of miners.

**Patterns of coal use differ among countries.** In mature economies, such as the United States, coal is used almost exclusively to generate electricity. In emerging economies, a significant portion of coal used is for industrial and commercial purposes as illustrated in Table 2.2 comparing coal use in the United States and China.<sup>4</sup>

We begin this exploration of possible futures for coal with a brief overview of its current use and associated CO<sub>2</sub> emissions, and projections to 2030, assuming there are no additional policies to restrict greenhouse gas emissions beyond those in place in 2007. For these business-as-usual projections we use the work of the U.S. Department of Energy's Energy Information Administration (EIA). We then turn to longer-term projections and consider the consequences for energy markets and coal use of alternative policies that place a penalty on carbon emissions. For this latter part of the assessment, we apply an economic model developed at MIT, to be described below. This model shows that, among other effects of such policies, a carbon charge<sup>5</sup> of sufficient magnitude will favor higher-efficiency coal-burning technologies and the application of carbon capture and sequestration (CSS), contributing to a reduction of emissions from coal and sustaining its use in the face of restrictions on CO<sub>2</sub>. In the longer-term projections, we focus on the U.S. and world totals, but we also include results for China to emphasize the role of large developing countries in the global outlook.

## THE OUTLOOK FOR COAL ABSENT ADDITIONAL CLIMATE POLICY

Each year in its *International Energy Outlook*, the DOE/EIA reviews selected energy trends. Table 2.3 summarizes the EIA's Reference Case projection of primary energy use (i.e., fossil fuels, hydro, nuclear, biomass, geothermal, wind and solar) and figures for coal consump-

tion alone. The projections are based on carbon emission regulations currently in effect. That is, developed countries that have ratified the Kyoto Protocol reduce their emissions to agreed levels through 2012, while developing economies and richer countries that have not agreed to comply with Kyoto (the United States and Australia) do not constrain their emissions growth. The report covers the period 1990 to 2030, and data are presented for countries grouped into two categories:

- OECD members, a richer group of nations including North America (U.S., Canada and Mexico), the EU, and OECD Asia (Japan, Korea, Australia and New Zealand).
- Non-OECD nations, a group of transition and emerging economies which includes Russia and other Non-OECD Europe and Eurasia, Non-OECD Asia (China, India and others), the Middle East, Africa, and Central and South America.

It can be seen that the non-OECD economies, though consuming far less energy than OECD members in 1990, are projected to surpass them within the next five to ten years. An even more dramatic picture holds for coal consumption. The non-OECD economies consumed about the same amount as the richer group in 1990, but are projected to consume twice as much by 2030. As would be expected, a similar picture holds for CO<sub>2</sub> emissions, as shown in Table 2.4. The non-OECD economies emitted less CO<sub>2</sub> than the mature ones up to the turn of the century, but because of their heavier dependence on coal, their emissions are expected to surpass those of the more developed group by 2010. The picture for emissions from coal burning, also shown in the table, is even more dramatic.

The qualitative conclusions to be drawn from these reference case EIA projections are summarized in Table 2.5, which shows the growth rates for energy and emissions for the period 2003–30. Worldwide energy consumption grows at about a 2% annual rate, with emerging economies increasing at a rate about three times that of OECD group. Emissions of CO<sub>2</sub> follow a similar pattern. Coal's contribution

**Table 2.3 World Consumption of Primary Energy and Coal 1990–2030**

	TOTAL PRIMARY ENERGY (QUADRILLION Btu)			TOTAL COAL (MILLION SHORT TONS)		
	OECD (U.S.)	NON-OECD	TOTAL	OECD (U.S.)	NON-OECD	TOTAL
1990	197 (85)	150	347	2,550 (904)	2,720	5,270
2003	234 (98)	186	421	2,480 (1,100)	2,960	5,440
2010	256 (108)	254	510	2,680 (1,230)	4,280	6,960
2015	270 (114)	294	563	2,770 (1,280)	5,020	7,790
2020	282 (120)	332	613	2,940 (1,390)	5,700	8,640
2025	295 (127)	371	665	3,180 (1,590)	6,380	9,560
2030	309 (134)	413	722	3440 (1,780)	7,120	10,560

*Source: DOE/EIA IEO (2006): Tables A1 & A6*

**Table 2.4 CO<sub>2</sub> Emissions by Region 1990–2030**

	TOTAL EMISSIONS (BILLION METRIC TONS CO <sub>2</sub> )			EMISSIONS FROM COAL (BILLION METRIC TONS CO <sub>2</sub> )			COAL % OF TOTAL
	OECD (U.S.)	NON- OECD	TOTAL	OECD (U.S.)	NON- OECD	TOTAL	
1990	11.4 (4.98)	9.84	21.2	4.02 (1.77)	4.24	8.26	39
2003	13.1 (5.80)	11.9	25.0	4.25 (2.10)	5.05	9.30	37
2010	14.2 (6.37)	16.1	30.3	4.63 (2.35)	7.30	11.9	39
2015	15.0 (6.72)	18.6	33.6	4.78 (2.40)	8.58	13.4	40
2020	15.7 (7.12)	21.0	36.7	5.06 (2.59)	9.76	14.8	40
2025	16.5 (7.59)	23.5	40.0	5.42 (2.89)	10.9	16.3	41
2030	17.5 (8.12)	26.2	43.7	5.87 (3.23)	12.2	18.1	41

*Source: DOE/EIA IEO (2006): Tables A10 & A13*

to total CO<sub>2</sub> emissions had declined to about 37% early in the century, and (as can be seen in Table 2.4) this fraction is projected to grow to over 40% by 2030. Clearly any policy designed to constrain substantially the total CO<sub>2</sub> contribution to the atmosphere cannot succeed unless it somehow reduces the contribution from this source.

**Table 2.5 Average Annual Percentage Growth 2002–2030**

	OECD	US	NON-OECD	CHINA	INDIA	TOTAL
Energy	1.0	1.2	3.0	4.2	3.2	2.0
Coal	1.2	1.8	3.3	4.2	2.7	2.5
Total CO <sub>2</sub>	1.1	1.3	3.0	4.2	2.9	2.1
Coal CO <sub>2</sub>	1.2	1.6	3.3	4.2	2.7	2.5

Source: DOE/IEA AEO 2006: Tables A1, A6, A10 & A13

## THE OUTLOOK FOR COAL UNDER POSSIBLE CO<sub>2</sub> PENALTIES

### The MIT EPPA Model and Case Assumptions

To see how CO<sub>2</sub> penalties might work, including their implications for coal use under various assumptions about competing energy sources, we explore their consequences for fuel and technology choice, energy prices, and CO<sub>2</sub> emissions. Researchers at MIT’s Joint Program on the Science and Policy of Global Change have developed a model that can serve this purpose. Their Emissions Predictions and Policy Analysis (EPPA) model is a recursive-dynamic multi-regional computable general equilibrium (CGE) model of the world economy.<sup>6</sup> It distinguishes sixteen countries or regions, five non-energy sectors, fifteen energy sectors and specific technologies, and includes a representation of household consumption behavior. The model is solved on a five-year time step to 2100, the first calculated year being 2005. Elements of EPPA structure relevant to this application include its equilibrium structure, its characterization of production sectors, the handling of international trade, the structure of household consumption, and drivers of the dynamic evolution of the model including the characterization of advanced or alternative technologies, importantly including carbon capture and storage (CCS).

The virtue of models of this type is that they can be used to study how world energy markets, as well as markets for other intermediate inputs and for final goods and services, would adapt to a policy change such as the adoption of a carbon emission tax, the establishment

of cap-and-trade systems, or implementation of various forms of direct regulation of emissions. For example, by increasing the consumer prices of fossil fuels, a carbon charge would have broad economic consequences. These include changes in consumer behavior and in the sectoral composition of production, switching among fuels, a shift to low-carbon energy resources, and investment in more efficient ways to get the needed services from a given input of primary energy. A model like EPPA gives a consistent picture of the future energy market that reflects these dynamics of supply and demand as well as the effects of international trade.

Naturally, in viewing the results of a model of this type, a number of its features and input assumptions should be kept in mind. These include, for example, assumptions about:

- Population and productivity growth that are built into the reference projection;
- The representation of the production structure of the economy and the ease of substitution between inputs to production, and the behavior of consumers in response to changing prices of goods and services;
- The cost and performance of various technology alternatives, importantly for this study including coal technologies (which have been calibrated to the estimates in Chapters 3 and 4 below) and competitor generation sources;
- The length of time to turn over the capital stock, which is represented by capital vintages in this model;
- The assumed handling of any revenues that might result from the use of a carbon tax, or from permit auctions under cap-and-trade systems.<sup>7</sup>

Thus our model calculations should be considered as illustrative, not precise predictions. The results of interest are not the absolute numbers in any particular case but the differences in outcomes for coal and CO<sub>2</sub> emissions among “what if” studies of different climate



policy regimes and assumptions about competing energy types. In the assessment below we test the response of the energy sector and its CO<sub>2</sub> emissions to alternative assumptions about the penalty imposed on emissions in various parts of the world and about the effect of two uncertain influences on coal use: the pace of nuclear power development and the evolution of natural gas markets.

To explore the potential effects of carbon policy, three cases are formulated: a reference or *Business as Usual* (BAU) case with no emissions policy beyond the first Kyoto period,<sup>8</sup> and two cases involving the imposition of a common global price on CO<sub>2</sub> emissions. The two policy cases, a *Low* and a *High CO<sub>2</sub> price* path, are shown in Figure 2.2, with the CO<sub>2</sub> penalty stated in terms of 1997 \$U.S. per ton of CO<sub>2</sub>. This penalty or emissions price can be thought of as the result of a global cap-and-trade regime, a system of harmonized carbon taxes, or even a combination of price and regulatory measures that combine to impose the marginal penalties on emissions. The *Low CO<sub>2</sub> Price* profile corresponds to the proposal of the National Energy Commission<sup>9</sup>, which we represent by applying its maximum or “safety valve” cap-and-trade price. It involves a penalty that begins in 2010 with \$7 per ton CO<sub>2</sub> and increases at a real rate (e.g., without inflation) of 5% per year thereafter. The *High CO<sub>2</sub> Price* case assumes the imposition of a larger initial charge of \$25 ton CO<sub>2</sub> in the year 2015 with a real rate of increase of 4% thereafter. One important question to be explored in the comparison of these two cases is the time when CSS technology may take a substantial role as an emissions reducing measure.

A second influence on the role of coal in future energy use is competition from nuclear generation. Here two cases are studied, shown in Table 2.6. In one, denoted as *Limited Nuclear*, it is assumed that nuclear generation, from its year 2000 level in the EPPA database of 1.95 million GWh, is held to 2.43 million GWh in 2050. At a capacity factor of 0.85, this corresponds to an expansion from a 1997 world installed total of about 261GW to some 327GW

**Figure 2.2 Scenarios of Penalties on CO<sub>2</sub> Emissions**  
(\$/t CO<sub>2</sub> in constant dollars)

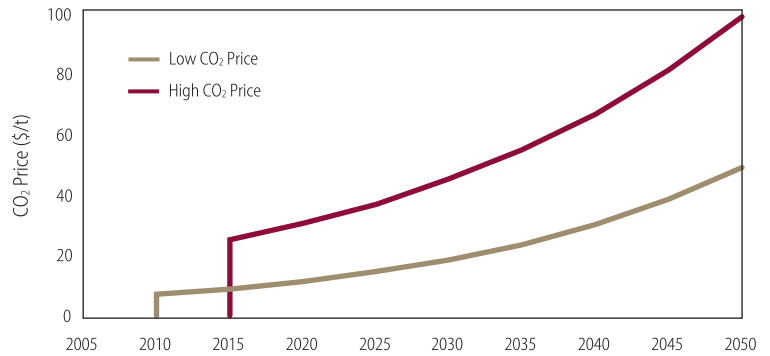

in 2050. The alternative case, denoted as *Expanded Nuclear* assumes that nuclear capacity grows to 1000GW over this period—a level identified as being feasible in the *MIT Future of Nuclear Power* study if certain conditions are met.<sup>10</sup>

The third influence on the role of coal studied here concerns the evolution of real natural gas prices over time. The EPPA model includes a sub-model of resources and depletion of fossil fuels including natural gas, and one scenario, denoted *EPPA-Ref Gas Price*, applies the model’s own projection of gas prices (which differ by model regions) under the supply and demand conditions in the various simulations. In the Business-as-Usual (BAU) case with limited nuclear expansion, the real U.S. gas price

**Table 2.6 Alternative Cases for Nuclear Generation**  
(Nuclear capacity in Million GWh/year)

REGION	1997	2050	
		LIMITED	EXPANDED
USA	0.57	0.58	2.23
Europe	0.76	0.94	1.24
Japan	0.28	0.42	0.48
Other OECD	0.07	0.10	0.34
FSU & EET	0.16	0.21	0.41
China	0.00	0.00	0.75
India	0.00	0.00	0.67
Other Asia	0.10	0.19	0.59
Rest of World	0.00	0.00	0.74
TOTAL	1.95	2.43	7.44

**Figure 2.3 Global CO<sub>2</sub> Emissions under Alternative Policies with Universal, Simultaneous Participation, Limited Nuclear Expansion and EPPA-Ref Gas Prices (GtCO<sub>2</sub>/year)**

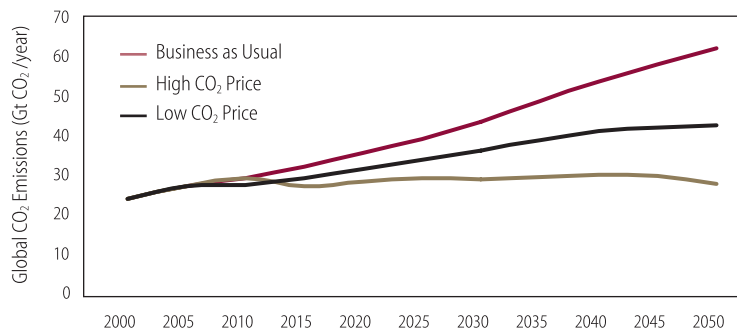

is projected to rise by 2050 by a factor of 3.6 over the base year (1997) price of \$2.33 per Mcf, which implies a price of around \$8.40 per Mcf in 2050 in 1997 prices. To test the effect of substantial new discovery and development of low-cost LNG transport systems, a second *Low Gas Price* case is explored. In this case the EPPA gas transport sub-model is overridden by a low-cost global transport system which leads to lower prices in key heavy gas-consuming regions. For example, with the *Low Gas Price* scenario, the real 2050 price multiple for the U.S. is only 2.4 over the base year, or a price of \$5.60/Mcf in 1997 prices.<sup>11</sup>

### Results Assuming Universal, Simultaneous Participation in CO<sub>2</sub> Emission Penalties

In order to display the relationships that underlie the future evolution of coal use, we begin with a set of policy scenarios where all nations adopt, by one means or another, to the carbon emissions penalties as shown in Figure 2.2. Were such patterns of emissions penalties adopted, they would be sufficient to stabilize global CO<sub>2</sub> emissions in the period between now and 2050. This result is shown in Figure 2.3 on the assumption of *Limited Nuclear* generation, and *EPPA-Ref Gas Price*.

If there is no climate policy, emissions are projected to rise to over 60 GtCO<sub>2</sub> by 2050. Under the *High CO<sub>2</sub> Price* path, by contrast, global emissions are stabilized by around 2015 at level of about 28 GtCO<sub>2</sub>. If only the *Low CO<sub>2</sub>*

*Price* path is imposed, emissions would not stabilize until around 2045 and then at a level of approximately 42 GtCO<sub>2</sub> per year.<sup>12</sup>

Figure 2.4 shows how global primary energy consumption adjusts in the EPPA model solution for the *High CO<sub>2</sub> Price* case with *Limited Nuclear* expansion and *EPPA-Ref* gas prices. The increasing CO<sub>2</sub> price leads to a reduction in energy demand over the decades and to adjustments in the composition of supply. For example, non-biomass renewables (e.g., wind) and commercial biomass (here expressed in terms of liquid fuel) both increase substantially.<sup>13</sup> Most important for this discussion is the effect on coal use. When the carbon price increases in 2015, coal use is initially reduced. However, in 2025 coal with CCS begins to gain market share, growing steadily to 2050 (and beyond) and leading to a resurgence of global coal consumption.

A further global picture of coal use under these alternative CO<sub>2</sub> price assumptions, assuming *Limited Nuclear* capacity and *EPPA-Ref Gas Price*, is shown in Table 2.7. Under the *Low CO<sub>2</sub> Price* trajectory, coal's contribution to 2050 global emissions is lowered from 32 GtCO<sub>2</sub> per year, to around 15 GtCO<sub>2</sub> per year while total coal consumption falls to 45% of its no-policy level (though still 100% above 2000 coal use). The contribution of carbon capture and storage (CCS) is relatively small in this case, because at this price trajectory CCS technology does not become economic until around 2035 or 2040, leading to a small market penetration by 2050. The picture differs substantially under assumption of the *High CO<sub>2</sub> Price* pattern. The contribution of CO<sub>2</sub> emissions from coal in 2050 is projected to be one-third that under the lower price path, yet coal use falls by only another 20% (and still remains 61% above the 2000 level). The key factor contributing to this result in 2050 can be seen in the third line in the table which shows the percentage of coal consumed using CCS technology. With higher CO<sub>2</sub> price levels early in the simulation period, CCS has the time and economic incentive to take a larger market share.

The point to take from Table 2.7 is that CO<sub>2</sub> mitigation policies at the level tested here will limit the expected growth of coal and associated emissions, but not necessarily constrict the production of coal below today's level. Also, the long-term future for coal use, and the achievement in CO<sub>2</sub> emissions abatement, are sensitive to the development and public acceptance of CCS technology and the timely provision of incentives to its commercial application.

An assumption of expanded nuclear capacity to the levels shown in Table 2.6 changes the global picture of primary energy consumption and the proportion met by coal. This case is shown in Figure 2.5 which, like Figure 2.4, imposes the high CO<sub>2</sub> price trajectory and EPPA-Ref gas prices. The possibility of greater nuclear expansion supports a small increase in total primary energy under no-policy conditions but leaves the total energy essentially unchanged under the pressure of high CO<sub>2</sub> prices. The main adjustment is in the consumption of coal, which is reduced from 161 EJ to 120 EJ in 2050 through a substitution of nuclear generation for coal with and without CO<sub>2</sub> capture and storage.

Table 2.8 provides some individual country detail for these assumptions and shows the sensitivity of the EPPA results to assumptions about nuclear expansion and natural gas prices. The top rows of the table again present the global figures for coal use along with the figures for the U.S. and China.<sup>14</sup> China's coal consumption at 27 EJ is slightly above the 24 EJ in the United States in 2000, but without climate policy, China's coal consumption is projected to increase to a level some 52% greater than that of the United States in 2050. On the other hand, the CO<sub>2</sub> penalty yields a greater percentage reduction in China than in the U.S.. By 2050 the *High CO<sub>2</sub> Price* has reduced Chinese use by 56%, but United States consumption is reduced by only 31%. The main reason for the difference in response is the composition of coal consumption, and to a lesser extent in a difference in the thermal efficiency of the electric power sectors of the two countries.

**Figure 2.4 Global Primary Energy Consumption under High CO<sub>2</sub> Prices (Limited Nuclear Generation and EPPA-Ref Gas Prices)**

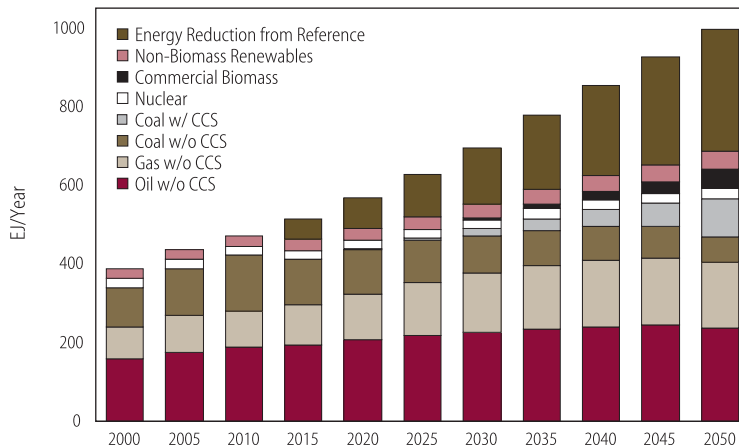
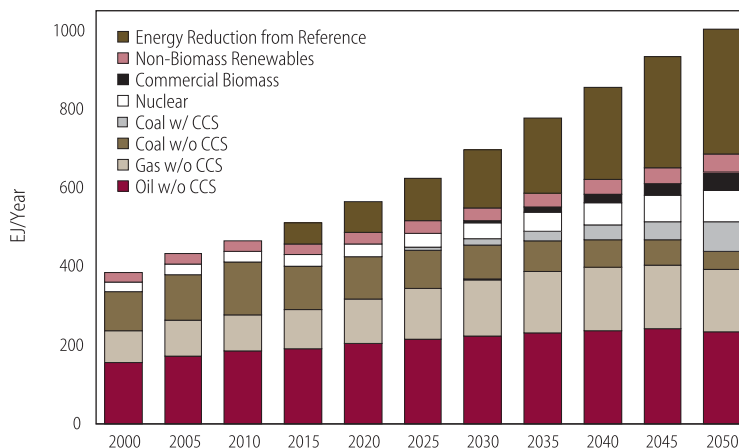

**Table 2.7 Implications for Global Coal Consumption of Alternative CO<sub>2</sub> Price Assumptions**

INDICATOR	BAU		LOW CO <sub>2</sub> PRICE 2050	HIGH CO <sub>2</sub> PRICE 2050
	2000	2050		
Coal CO <sub>2</sub> emissions (GtCO <sub>2</sub> /yr)	9	32	15	5
Coal Consumption (EJ/yr)	100	448	200	161
% Coal with CCS	0	0	4	60

*Assumes universal, simultaneous participation, limited nuclear expansion & EPPA-Ref gas price.*

**Figure 2.5 Global Primary Energy Consumption under High CO<sub>2</sub> Prices (Expanded Nuclear Generation and EPPA-Ref Gas Prices)**



By 2050 in the reference scenario (*EPPA-Ref Gas Price and Limited Nuclear*), 54% of coal use in China is in non-electric power sectors compared with only 5% in the U.S.. Under the

**Table 2.8 Coal Consumption**

SCENARIO			BAU (EJ)		LOW CO <sub>2</sub> PRICE (EJ)	HIGH CO <sub>2</sub> PRICE (EJ)
GAS PRICE	NUCLEAR	REGION	2000	2050	2050	2050
EPPA-REF	LIMITED	GLOBAL	100	448	200	161
		US	24	58	42	40
		CHINA	27	88	37	39
EPPA-REF	EXPANDED	GLOBAL	99	405	159	121
		US	23	44	29	25
		CHINA	26	83	30	31
LOW	EXPANDED	GLOBAL	95	397	129	89
		US	23	41	14	17
		CHINA	26	80	13	31

*Assumes universal, simultaneous participation.*

*High CO<sub>2</sub> Price* policy, China’s share of coal consumption in the other sectors declines to 12%, while the U.S. share of coal consumption outside of the electricity sector drops to 3%. Within the electric sector, U.S. power plants are relatively more thermally efficient than in China, so opportunities to lower coal consumption in China’s power sector are greater.

Table 2.8 also displays the effect on coal use of alternative assumptions about the expansion of nuclear power. A growth of nuclear generating capacity at the level assumed in the *Expanded Nuclear* case directly displaces electricity from coal. For example, under *Business as Usual* the provision of expanded nuclear generation reduces 2050 global coal use from 448 to 405 EJ. This effect continues under the cases with penalties on CO<sub>2</sub> emissions. Moreover, if the influence of low gas prices is added to the greater nuclear penetration (a case shown in the bottom three rows) coal use declines further. Under these conditions, global coal use falls below 2000 levels under the *High CO<sub>2</sub> Price* case, and Chinese consumption would only reach its 2000 level in the years nearing 2050.

It can be seen in Figure 2.3 that in 2010 global CO<sub>2</sub> emissions are lower at the *Low* than at the *High CO<sub>2</sub> Price* scenario, whereas Table 2.7 indicates that by 2050 emissions are far lower at the stricter emissions penalty. This pattern is the result of the differential timing of the start

of the mitigation policy and the influence of the two price paths on CCS, for which more detail is provided in Table 2.9. The lower CO<sub>2</sub> price path starts earlier and thus influences the early years, but under the high price path CCS enters earlier and, given the assumptions in the EPPA model about the lags in market penetration of such a new and capital-intensive technology, it has more time to gain market share. So, under *Limited Nuclear* growth and *EPPA-Ref Gas Price*, CCS-based generation under the *High CO<sub>2</sub> Price* reaches a global level ten times that under the *Low CO<sub>2</sub> Price*. An *Expanded Nuclear* sector reduces the total CCS installed in 2050 by about one-quarter.

The *Low Gas Price* assumption has only a small effect on CCS when the penalty on CO<sub>2</sub> emissions is also low, but it has a substantial effect under the *High CO<sub>2</sub> Price* scenario because the low gas prices delay the initial adoption of CCS. The gas price has a less pronounced effect after 2050.

Accompanying these developments are changes in the price of coal. The EPPA model treats coal as a commodity that is imperfectly substitutable among countries (due to transport costs and the imperfect substitutability among various coals), so that it has a somewhat different price from place to place. Table 2.10 presents these prices for the U.S. and China. Under the no-policy BAU (with *Limited Nuclear* and *EPPA-Ref Gas Price*), coal prices are projected to increase by 47% in the U.S. and by 60% in China.<sup>15</sup> Each of the changes explored—a charge on CO<sub>2</sub>, expanded nuclear capacity or lower gas prices—would lower the demand for coal and thus its mine-mouth price. With high CO<sub>2</sub> prices, more nuclear and cheaper natural gas, coal prices are projected to be essentially the same in 2050 as they were in 2000.

### Results Assuming Universal but Lagged Participation of Emerging Economies

The previous analysis assumes that all nations adopt the same CO<sub>2</sub> emission charge schedule. Unfortunately, this is a highly unlikely

outcome. The Kyoto Protocol, for example, sets emission reduction levels only for the developed and transition (Annex B) economies. The emissions of developing nations (classified as Non-Annex B), including China and India, are not constrained by the Protocol and at present there is no political agreement about how these nations might participate in a carbon regime of CO<sub>2</sub> emissions restraint.<sup>16</sup> Clearly if the fast growing developing economies do not adopt a carbon charge, the world level of emissions will grow faster than presented above.

To test the implications of lagged participation by emerging economies we explore two scenarios of delay in their adherence to CO<sub>2</sub> control regimes. They are shown in Figure 2.6. The *High CO<sub>2</sub> Price* trajectory from the earlier figures is repeated in the figure, and this price path is assumed to be followed by the Annex B parties. The trajectory marked *10-year Lag* has the developing economies maintaining a carbon charge that developed economies adopted ten years previously. The trajectory marked *Temp Lag* assumes that after 20 years the developing economies have returned to the carbon charge trajectory of the developed economies. In this latter case, developing economies would go through a transition period of a higher rate of increase in CO<sub>2</sub> prices than the 4% rate that is simulated for the developed economies and eventually (around 2045), the same CO<sub>2</sub> price level would be reached as in the case of universal participation. Note that these scenarios are not intended as realistic portrayals of potential future CO<sub>2</sub> markets. They simply provide a way to explore the implications of lagged accession to a climate agreement, however it might be managed.

Figure 2.7 projects the consequences of these different assumptions about the adherence of developing economies to a program of CO<sub>2</sub> penalties assuming the *Limited Nuclear* expansion and *EPPA-Ref Gas Price* path. First of all, the figure repeats the BAU case from before, and a case marked *High CO<sub>2</sub> Price*, which is the same scenario as before when all nations follow the *High CO<sub>2</sub> Price* path. The *Annex*

**Table 2.9 Coal Capture and Sequestration Plants: Output (EJ) and Percentage of Coal Consumption**

SCENARIO			BAU		LOW CO <sub>2</sub> PRICE	HIGH CO <sub>2</sub> PRICE
GAS	NUCLEAR	REGION	2000	2050	2050	2050
EPPA-Ref	Limited	Global	0	0	2.4 (4%)	29.2 (60%)
		US	0	0	0.1 (<1%)	9.4 (76%)
		China	0	0	1.8 (16%)	11.0 (88%)
EPPA-Ref	Expanded	Global	0	0	2.1 (4%)	22.5 (62%)
		US	0	0	0.1 (1%)	6.6 (86%)
		China	0	0	1.6 (18%)	8.5 (85%)
Low	Expanded	Global	0	0	2.1 (5%)	14.2 (52%)
		US	0	0	0.1 (<1%)	1.1 (22%)
		China	0	0	1.5 (36%)	8.2 (85%)

*Assumes universal, simultaneous participation.*

**Table 2.10 Coal Price Index (2000 = 1)**

SCENARIO			BAU		LOW CO <sub>2</sub> PRICE	HIGH CO <sub>2</sub> PRICE
GAS	NUCLEAR	REGION	2000	2050	2050	2050
EPPA-Ref	Limited	US	1.00	1.47	1.21	1.17
		China	1.00	1.60	1.24	1.14
EPPA-Ref	Expanded	US	1.00	1.39	1.14	1.08
		China	1.00	1.66	1.17	1.07
Low	Expanded	US	1.00	1.38	1.07	1.03
		China	1.00	1.64	1.08	1.01

*Assumes universal, simultaneous participation.*

**Figure 2.6 Scenarios of Penalties on CO<sub>2</sub> Emissions: High Price for Annex B Nations and Two Patterns of Participation by Non-Annex B Parties (\$/t CO<sub>2</sub>)**

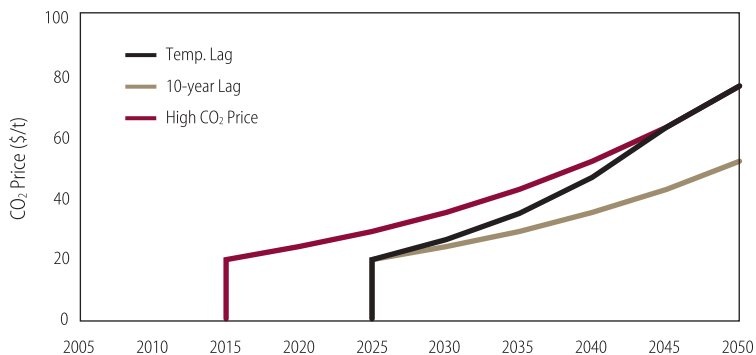

**Figure 2.7 Global CO<sub>2</sub> Emissions under BAU and Alternative Scenarios for Non-Annex B Accession to the High CO<sub>2</sub> Price Path**

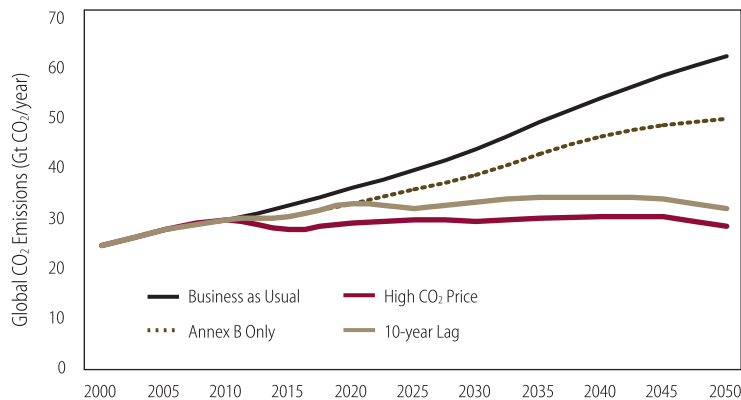

*B Only* case considers the implications if the Non-Annex B parties never accept any CO<sub>2</sub> penalty, in which case total emissions continue to grow although at a slower pace than under BAU.

The next case assumes developing economies adhere to a “high” carbon price but with a lag of ten years after developed economies. The trend is clear: (1) if developing economies do not adopt a carbon charge, stabilization of emissions by 2050 cannot be achieved under this price path; and (2) if developing economies adopt a carbon charge with a time lag, stabilization is possible, but it is achieved at a later time and at a higher level of global emissions, depending upon the precise trajectory adopted by the developing economies. For example, if developing economies maintain a carbon tax with a lag of 10 years behind the developed ones, then cumulative CO<sub>2</sub> emissions through 2050 will be 123 GtCO<sub>2</sub> higher than if developing economies adopted the simulated carbon charge with no lag. If developing economies adopted the carbon tax with a ten-year lag but converged with the developed economies tax 20 years later (noted as *Temp Lag* in Figure 2.6 but not shown in Figure 2.7) then cumulative CO<sub>2</sub> emissions through 2050 would be 97 GtCO<sub>2</sub> higher than if developing economies adopted the tax with no lag. The significance of these degrees of delay can be understood in comparison with cumulative CO<sub>2</sub> emissions under the *High CO<sub>2</sub> Price* case over the period

2000 to 2050, which is estimated to be 1400 GtCO<sub>2</sub> under the projections used here.<sup>17</sup>

## THE ROLE OF CCS IN A CARBON CONSTRAINED WORLD

The importance of CCS for climate policy is underlined by the projection for coal use if the same CO<sub>2</sub> emission penalty is imposed and CCS is not available, as shown in Table 2.11. Under *Limited Nuclear* expansion the loss of CCS would lower coal use in 2050 by some 28% but increase global CO<sub>2</sub> emissions by 14%. With *Expanded Nuclear* capacity, coal use and emissions are lower than in the limited nuclear case and the absence of CCS has the same effect. Depending on the nuclear assumption the loss of the CCS option would raise 2050 CO<sub>2</sub> emissions by between 10% and 15%.

This chart motivates our study’s emphasis on coal use with CCS. Given our belief that coal will continue to be used to meet the world’s energy needs, the successful adoption of CCS is critical to sustaining future coal use in a carbon-constrained world. More significantly considering the energy needs of developing countries, this technology may be an essential component of any attempt to stabilize global emissions of CO<sub>2</sub>, much less to meet the Climate Convention’s goal of stabilized atmospheric concentrations. This conclusion holds even for plausible levels of expansion of nuclear power or for policies stimulating the other approaches to emissions mitigation listed at the outset of this chapter.

## CONCLUDING OBSERVATIONS

A central conclusion to be drawn from our examination of alternative futures for coal is that **if carbon capture and sequestration is successfully adopted, utilization of coal likely will expand even with stabilization of CO<sub>2</sub> emissions.** Though not shown here, extension of these emissions control scenarios further into the future shows continuing growth

**Table 2.11 Coal Consumption (EJ) and Global CO<sub>2</sub> Emissions (Gt/yr) in 2000 and 2050 with and without Carbon Capture and Storage**

	BAU		LIMITED NUCLEAR		EXPANDED NUCLEAR	
	2000	2050	WITH CCS	WITHOUT CCS	WITH CCS	WITHOUT CCS
Coal Use: Global	100	448	161	116	121	78
U.S.	24	58	40	28	25	13
China	27	88	39	24	31	17
Global CO <sub>2</sub> Emissions	24	62	28	32	26	29
CO <sub>2</sub> Emissions from Coal	9	32	5	9	3	6

*Assumes universal, simultaneous participation, High CO<sub>2</sub> prices and EPPA-Ref gas prices.*

in coal use provided CCS is available. Also to be emphasized is that market adoption of CCS requires the incentive of a significant and widely applied charge for CO<sub>2</sub> emissions.

All of these simulations assume that CCS will be available, and proven socially and environmentally acceptable, if and when more widespread agreement is reached on imposing a charge on CO<sub>2</sub> emissions. This technical option is not available in this sense today, of course. Many years of development and demonstration will be required to prepare for its successful, large scale adoption in the U.S. and elsewhere. A rushed attempt at CCS implementation in the face of urgent climate concerns could lead to excess cost and heightened local environmental concerns, potentially leading to long delays in implementation of this important option. Therefore these simulation studies underscore the need for development work now at a scale appropriate to the technological and societal challenge. The task of the following chapters is to explore the components of such a program—including generation and capture technology and issues in CO<sub>2</sub> storage—in a search for the most effective and efficient path forward.

## CITATIONS AND NOTES

1. S. Ansolabehere et al., *The Future of Nuclear Power: An Interdisciplinary MIT Study*, 2003, Cambridge, MA. Found at: [web.mit.edu/nuclearpower](http://web.mit.edu/nuclearpower).
2. U.S. Department of Energy, Energy Information Administration, *International Energy Outlook 2006*, DOE/EIA-0484(2006) – referred to in the text as DOE/EIA IEO (2006).
3. U.S. Department of Energy, Energy Information Administration, *International Energy Annual 2004* (posted July 12, 2006).
4. In China there has been a history of multiple official estimates of coal production and upward revisions for previous years. Some government statistics show higher numbers for the 2003 and 2004 quantities in Tables 2.1 and 2.2.
5. This charge may be imposed as a result of a tax on carbon content or as the result of a cap-and-trade system that would impose a price on CO<sub>2</sub> emissions. In the remainder of the paper, the terms charge, price, tax, and penalty are used interchangeably to denote the imposition of a cost on CO<sub>2</sub> emissions.
6. The MIT EPPA model is described by Paltsev, S., J.M. Reilly, H.D. Jacoby, R.S. Eckaus, J. McFarland, M. Sarofim, M. Asadoorian & M. Babiker, *The MIT Emissions Prediction and Policy Analysis (EPPA) Model: Version 4*, MIT Joint Program on the Science and Policy of Global Change, Report No 125, August 2005. The model as documented there has been extended by the implementation of an improved representation of load dispatching in the electric sector—an improvement needed to properly assess the economics of CCS technology. It is assumed that all new coal plants have efficiencies corresponding to supercritical operation, that U.S. coal fired generation will meet performance standards for SO<sub>2</sub> and NO<sub>x</sub>, and Hg similar to those under the EPA's Clean Air Interstate Rule and Clean Air Mercury Rules.
7. The simulations shown here assume any revenues from taxes or auctioned permits are recycled directly to consumers. Alternative formulations, such as the use of revenues to reduce other distorting taxes, would have some effect on growth and emissions but would not change the insights drawn here from the comparison of policy cases.

8. The Kyoto targets are not imposed in either the projections of either the EIA or the EPPA simulations because the target beyond 2012 is not known nor are the methods by which the first commitment period targets might actually be met. Imposition of the existing Kyoto targets would have an insignificant effect on the insights to be drawn from this analysis. Note also that neither the EIA analyses nor the EPPA model are designed to try to represent short-term fluctuations in fuel markets, as occurred for example in the wake of supply disruptions in 2005.
9. National Commission on Energy Policy, *Ending the Energy Stalemate: A Bipartisan Strategy to Meet America's Energy Challenges*, December 2004.
10. The range of scenarios may be compared with the DOE/IEA IEO (2006), which projects nuclear generation of 3.29 million GWh in 2030 with no difference between its Reference, High and Low growth cases.
11. These paths for the U.S. may be compared with the DOE/IEA Annual Energy Outlook (2006) which projects a 65% increase in U.S. natural gas prices from 2000 to 2030, whereas EPPA projects a 100% rise over this period. On the other hand our Low price assumption shows 70% growth, very close to the AEO projection for the U.S.
12. In these EPPA calculations the focus is on emissions, but it is important to remember that higher emission levels translate into higher global mean greenhouse gas concentrations and it is the concentration of greenhouse gases that influences global climate. These carbon penalties succeed in stabilizing carbon emissions, not atmospheric concentrations which would continue to rise over the period shown in Figure 2.3.
13. The global 2050 biomass production of 48 EJ is expressed in the figure in liquid fuel units. The implied quantity of dry biomass input is approximately 120 EJ. Following the standard accounting convention, the global primary input to nuclear power is expressed in equivalent heat units of fossil electricity. Because fossil generation is becoming more (thermally) efficient in this projection nuclear power appears not to be increasing in the figure when in fact it is growing according to the "limited" case in Table 2.6. The same procedure is applied to hydroelectric and non-biomass renewable sources of electricity.
14. Calibration of the EPPA model has applied the official data on Chinese coal as reported in DOE/IEA IEO. Higher estimates of recent and current consumption are also available from Chinese government agencies (see Endnote 4) and if they prove correct then both Chinese and world coal consumption and emissions are higher than shown in these results. In addition, there is uncertainty in all these projections, but the uncertainty is especially high for an economy in rapid economic transition, like China.
15. The EPPA model projects a slightly more rapid coal price growth under these conditions than does the DOE/EIA. Its Annual Energy Outlook (2006) shows a 20% minimum price increase 2000 to 2030 for the U.S., whereas EPPA projects about a 10% increase over this period.
16. The Kyoto regime permits "cooperative development measures" that allow Annex B countries to earn emission reduction credits by investing in CO<sub>2</sub> reduction projects in emerging economies. The quantitative impact that CDM might make to global CO<sub>2</sub> reductions is not considered in our study, and CDM credits are not included in this version of the EPPA model.
17. If official statistics of recent Chinese coal consumption prove to be an underestimate (see Endnotes 4 and 14), then very likely the emissions shown in Figure 2.6, importantly including the excess burden of a 10-year lag by developing countries, would be increased.



# Chapter 3 — Coal-Based Electricity Generation

## INTRODUCTION

In the U.S., coal-based power generation is expanding again; in China, it is expanding very rapidly; and in India, it appears on the verge of rapid expansion. In all these countries and worldwide, the primary generating technology is pulverized coal (PC) combustion. PC combustion technology continues to undergo technological improvements that increase efficiency and reduce emissions. However, technologies favored for today's conditions may not be optimum under future conditions. In particular, carbon dioxide capture and sequestration in coal-based power generation is an important emerging option for managing carbon dioxide emissions while meeting growing electricity demand, but this would add further complexity to the choice of generating technology.

The distribution of coal-based generating plants for the U. S. is shown in Figure 3.1. Most of the coal-based generating units in the U. S. are between 20 and 55 years old; the average age of the fleet is over 35 years[1]. Coal-based generating units less than 35 years old average about 550 MW<sub>e</sub>; older generating units are typically smaller. With current life-extension capabilities, many of these units could, on-average, operate another 30+ years. Units that are less than about 50 years old are essentially all air-blown, PC combustion units. The U.S. coal fleet average generating efficiency is about 33%, although a few, newer generating units exceed 36% efficiency [2][3]. Increased generating efficiency is important, since it translates directly into lower criteria pollutant emissions (at a given re-

moval efficiency) and lower carbon dioxide emissions per kW<sub>e</sub>-h of electricity generated.

## GENERATING TECHNOLOGIES — OVERVIEW

This chapter evaluates the technologies that are either currently commercial or will be commercially viable in the near term for electricity generation from coal. It focuses primarily on the U. S., although the analysis is more broadly applicable. We analyze these generating technologies in terms of the cost of electricity produced by each, without and with carbon dioxide (CO<sub>2</sub>) capture, and their applicability, efficiency, availability and reliability. Power generation from coal is subject to a large number of variables which impact technology choice, operating efficiency, and cost of electricity (COE) produced [4]. Our approach here was to pick a point set of conditions at which to compare each of the generating technologies, using a given generating unit design model to provide consistency. We then consider how changes from this point set of conditions, such as changing coal type, impact the design, operation, and cost of electricity (COE) for each technology. We also consider emissions control and retrofits for CO<sub>2</sub> capture for each technology. Appendix 3.A summarizes coal type and quality issues, and their impact.

For the technology comparisons in this chapter, each of the generating units considered was a green-field unit which contained all the emissions control equipment required to operate slightly below current, low, best-demonstrated criteria emissions performance levels.

**Figure 3.1 Distribution of U. S. Coal-Based Power Plants. Data from 2002 USEPA eGRID database; Size Of Circles Indicate Power Plant Capacity.**

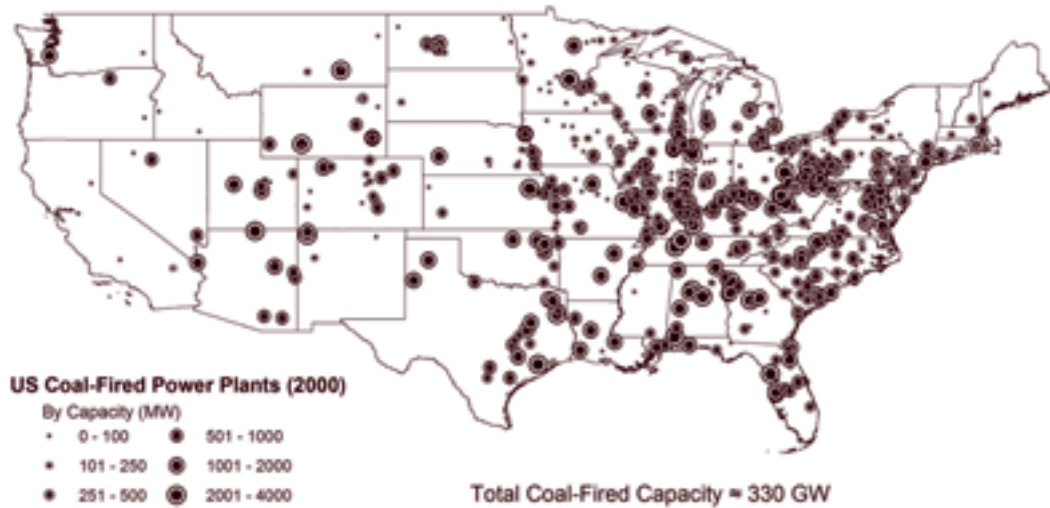

To evaluate the technologies on a consistent basis, the design performance and operating parameters for these generating technologies were based on the Carnegie Mellon Integrated Environmental Control Model, version 5.0 (IECM) [5] which is a modeling tool specific to coal-based power generation [6] [7]. The units all use a standard Illinois # 6 bituminous coal, a high-sulfur, Eastern U.S. coal with a moderately high heating value (3.25 wt% sulfur & 25,350 kJ/kg (HHV)). Detailed analysis is given in Table A-3.B.1 [5] (Appendix 3.B).

**GENERATING EFFICIENCY** The fraction of the thermal energy in the fuel that ends up in the net electricity produced is the generating efficiency of the unit [8]. Typical modern coal units range in thermal efficiency from 33% to 43% (HHV). Generating efficiency depends on a number of unit design and operating parameters, including coal type, steam temperature and pressure, and condenser cooling water temperature [9]. For example, a unit in Florida will generally have a lower operating efficiency than a unit in northern New England or in northern Europe due to the higher cooling water temperature in Florida. The difference in generating efficiency could be 2 to 3 percentage points. Typically, units operated at near capacity exhibit their highest efficiency; unit cycling and operating below capacity result in lower efficiency.

### LEVELIZED COST OF ELECTRICITY

The levelized cost of electricity (COE) is the constant dollar electricity price that would be required over the life of the plant to cover all operating expenses, payment of debt and accrued interest on initial project expenses, and the payment of an acceptable return to investors. Levelized COE is comprised of three components: capital charge, operation and maintenance costs, and fuel costs. Capital cost is generally the largest component of COE. This study calculated the capital cost component of COE by applying a carrying charge factor of 15.1% to the total plant cost (TPC). Appendix 3.C provides the basis for the economics discussed in this chapter.

### AIR-BLOWN COAL COMBUSTION GENERATING TECHNOLOGIES

In the next section we consider the four primary air-blown coal generating technologies that compose essentially all the coal-based power generation units in operation today and being built. These include PC combustion using subcritical, supercritical, or ultra-supercritical steam cycles designed for Illinois #6 coal and circulating fluid-bed (CFB) combustion designed for lignite. Table 3.1 summariz-

**Table 3.1 Representative Performance And Economics For Air-Blown PC Generating Technologies**

	SUBCRITICAL PC		SUPERCRITICAL PC		ULTRA-SUPERCRITICAL PC		SUBCRITICAL CFB <sup>6</sup>	
	W/O CAPTURE	W/ CAPTURE	W/O CAPTURE	W/ CAPTURE	W/O CAPTURE	W/ CAPTURE	W/O CAPTURE	W/ CAPTURE
<b>PERFORMANCE</b>								
Heat rate (1), Btu/kW <sub>e</sub> -h	9,950	13,600	8,870	11,700	7,880	10,000	9,810	13,400
Generating efficiency (HHV)	34.3%	25.1%	38.5%	29.3%	43.3%	34.1%	34.8%	25.5%
Coal feed, kg/h	208,000	284,000	185,000	243,000	164,000	209,000	297,000	406,000
CO <sub>2</sub> emitted, kg/h	466,000	63,600	415,000	54,500	369,000	46,800	517,000	70,700
CO <sub>2</sub> captured at 90%, kg/h (2)	0	573,000	0	491,000	0	422,000	0	36,000
CO <sub>2</sub> emitted, g/kW <sub>e</sub> -h	931	127	830	109	738	94	1030	141
<b>COSTS</b>								
Total Plant Cost, \$/kW <sub>e</sub> (3)	1,280	2,230	1,330	2,140	1,360	2,090	1,330	2,270
Inv.Charge, ¢/kW <sub>e</sub> -h @ 15.1% (4)	2.60	4.52	2.70	4.34	2.76	4.24	2.70	4.60
Fuel, ¢/kW <sub>e</sub> -h @ \$1.50/MMBtu	1.49	2.04	1.33	1.75	1.18	1.50	0.98	1.34
O&M, ¢/kW <sub>e</sub> -h	0.75	1.60	0.75	1.60	0.75	1.60	1.00	1.85
<b>COE, ¢/kW<sub>e</sub>-h</b>	<b>4.84</b>	<b>8.16</b>	<b>4.78</b>	<b>7.69</b>	<b>4.69</b>	<b>7.34</b>	<b>4.68</b>	<b>7.79</b>
Cost of CO <sub>2</sub> avoided <sup>5</sup> vs. same technology w/o capture, \$/tonne	41.3		40.4		41.1		39.7	
Cost of CO <sub>2</sub> avoided <sup>5</sup> vs. supercritical w/o capture, \$/tonne	48.2		40.4		34.8		42.8	
<b>Basis:</b> 500 MW <sub>e</sub> net output. Illinois # 6 coal (61.2% wt C, HHV = 25,350 kJ/kg), 85% capacity factor								
<i>(1) efficiency = 3414 Btu/kW<sub>e</sub>-h/(heat rate);</i>								
<i>(2) 90% removal used for all capture cases</i>								
<i>(3) Based on design studies and estimates done between 2000 &amp; 2004, a period of cost stability, updated to 2005\$ using CPI inflation rate. 2007 cost would be higher because of recent rapid increases in engineering and construction costs, up 25 to 30% since 2004.</i>								
<i>(4) Annual carrying charge of 15.1% from EPRI-TAG methodology for a U.S. utility investing in U.S. capital markets; based on 55% debt @ 6.5%, 45% equity @ 11.5%, 38% tax rate, 2% inflation rate, 3 year construction period, 20 year book life, applied to total plant cost to calculate investment charge</i>								
<i>(5) Does not include costs associated with transportation and injection/storage</i>								
<i>(6) CFB burning lignite with HHV = 17,400 kJ/kg and costing \$1.00/million Btu</i>								

es representative operating performance and economics for these air-blown coal combustion generating technologies. Appendix 3.C provides the basis for the economics. PC combustion or PC generation will be used to mean air-blown pulverized coal combustion for the rest of this report, unless explicitly stated to be oxy-fuel PC combustion for oxygen-blown PC combustion.

## **PULVERIZED COAL COMBUSTION POWER GENERATION: WITHOUT CO<sub>2</sub> CAPTURE**

**SUBCRITICAL OPERATION** In a pulverized coal unit, the coal is ground to talcum-powder fineness, and injected through burners into the furnace with combustion air [10-12]. The fine coal particles heat up rapidly, undergo pyrolysis and ignite. The bulk of the combustion air is then mixed into the flame to completely burn the coal char. The flue gas from the boiler passes through the flue gas clean-up units to remove particulates, SO<sub>x</sub>, and NO<sub>x</sub>. The flue gas exiting the clean-up section meets criteria

pollutant permit requirements, typically contains 10–15% CO<sub>2</sub> and is essentially at atmospheric pressure. A block diagram of a subcritical PC generating unit is shown in Figure 3.2. Dry, saturated steam is generated in the furnace boiler tubes and is heated further in the superheater section of the furnace. This high-pressure, superheated steam drives the steam turbine coupled to an electric generator. The low-pressure steam exiting the steam turbine is condensed, and the condensate pumped back to the boiler for conversion into steam. Subcritical operation refers to steam pressure and temperature below 22.0 MPa (~3200 psi) and about 550° C (1025° F) respectively. Subcritical PC units have generating efficiencies between 33 to 37% (HHV), dependent on coal quality, operations and design parameters, and location.

Key material flows and conditions for a 500 MW<sub>e</sub> subcritical PC unit are given in Figure 3.2 [5, 13]. The unit burns 208,000 kg/h (208 tonnes/h [14]) of coal and requires about 2.5 million kg/h of combustion air. Emissions control was designed for 99.9% PM and 99+% SO<sub>x</sub> reductions and greater than about 90% NO<sub>x</sub> reduction. Typical subcritical steam cycle conditions are 16.5 MPa (~2400 psi) and 540° C (1000° F) superheated steam. Under these operating conditions (Figure 3.2), IECM projects an efficiency of 34.3% (HHV) [15]. More detailed material flows and operating conditions are given in Appendix 3.B, Figure

A-3.B.2, and Table 3.1 summarizes the CO<sub>2</sub> emissions.

The coal mineral matter produces about 22,800 kg/h (23 tonnes/h) of fly and bottom ash. This can be used in cement and/or brick manufacture. Desulfurization of the flue gas produces about 41,000 kg/h (41 tonnes/h) of wet solids that may be used in wallboard manufacture or disposed of in an environmentally safe way.

**SUPERCRITICAL AND ULTRA-SUPERCRITICAL OPERATION** Generating efficiency is increased by designing the unit for operation at higher steam temperature and pressure. This represents a movement from subcritical to supercritical to ultra-supercritical steam parameters [16]. Supercritical steam cycles were not commercialized until the late 1960s, after the necessary materials technologies had been developed. A number of supercritical units were built in the U.S. through the 1970's and early 80's, but they were at the limit of the then-available materials and fabrication capabilities, and some problems were encountered [17]. These problems have been overcome for supercritical operating conditions, and supercritical units are now highly reliable. Under supercritical conditions, the supercritical fluid is expanded through the high-pressure stages of a steam turbine, generating electricity. To recharge the steam properties and increase the amount of power generated, after expansion through the high-pressure turbine stages, the

**Figure 3.2 Subcritical 500 MW<sub>e</sub> Pulverized Coal Unit without CO<sub>2</sub> Capture**

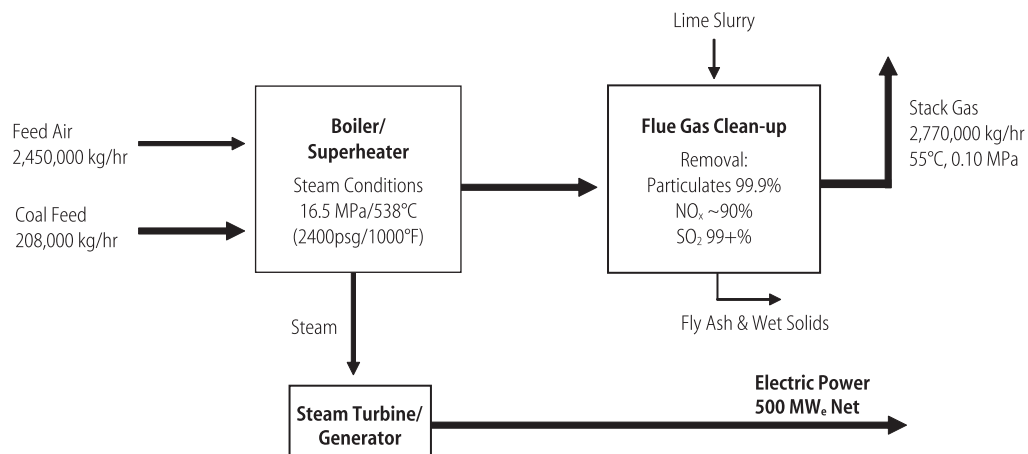

**Figure 3.3 Ultra-Supercritical 500 MW<sub>e</sub> Pulverized Coal Unit without CO<sub>2</sub> Capture**

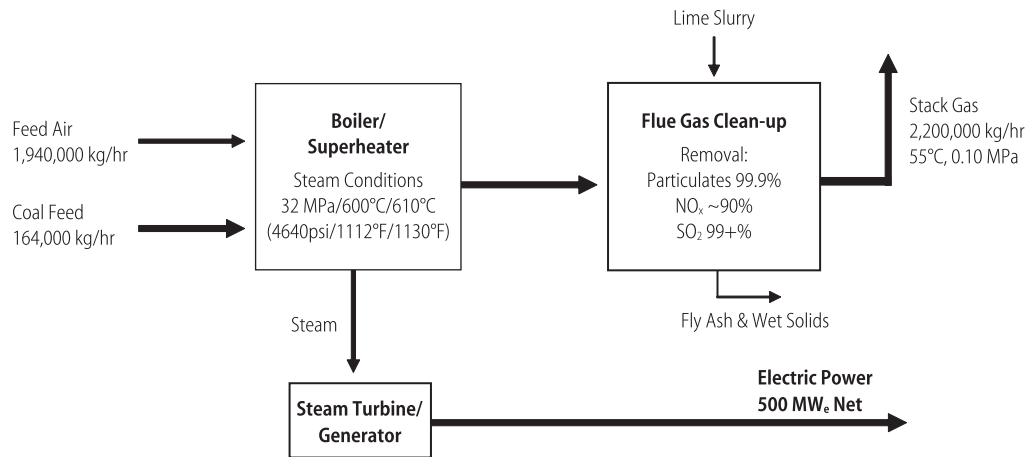

steam is sent back to the boiler to be reheated. Reheat, single or double, increases the cycle efficiency by raising the mean temperature of heat addition to the cycle.

Supercritical electricity generating efficiencies range from 37 to 40% (HHV), depending on design, operating parameters, and coal type. Current state-of-the-art supercritical PC generation involves 24.3 MPa (~3530 psi) and 565° C (1050° F), resulting in a generating efficiency of about 38% (HHV) for Illinois #6 coal.

Meanwhile, new materials capabilities have been further expanding the potential operating range. To take advantage of these developments, the power industry, particularly in Europe and Japan, continues to move to higher steam pressure and temperature, primarily higher temperatures. Operating steam cycle conditions above 565° C (>1050° F) are referred to as ultra-supercritical. A number of ultra-supercritical units operating at pressures to 32 MPa (~4640 psi) and temperatures to 600/610° C (1112-1130° F) have been constructed in Europe and Japan [18]. Operational availability of these units to date has been comparable to that of subcritical plants. Current materials research and development is targeting steam cycle operating conditions of 36.5 to 38.5 MPa (~5300-5600 psi) and temperatures of 700-720° C (1290-1330° F)[19]. These conditions should increase generating efficiency to the 44 to 46% (HHV) range for

bituminous coal, but require further materials advances, particularly for manufacturing, field construction, and repair.

Figure 3.3 is a block diagram of a 500 MW<sub>e</sub> ultra-supercritical PC generating unit showing key flows. The coal/combustion side of the boiler and the flue gas treatment are the same as for a subcritical boiler. Coal required to generate a given amount of electricity is about 21% lower than for subcritical generation, which means that CO<sub>2</sub> emissions per MW<sub>e</sub>-h are reduced by 21%. The efficiency projected for these design operating conditions is 43.3% (HHV) (Figure 3.3) vs. 34.3% for subcritical conditions. More detailed material and operating information is given in Appendix 3.B. Table 3.1 summarizes the performance for subcritical, supercritical, and ultra-supercritical operation.

**FLUID-BED COMBUSTION** A variation on PC combustion is fluid-bed combustion in which coal is burned with air in a fluid bed, typically a circulating fluid bed (CFB)[20-22]. CFBs are best suited to low-cost waste fuels and low-quality or low heating value coals. Crushed coal and limestone are fed into the bed, where the limestone undergoes calcination to produce lime (CaO). The fluid bed consists mainly of lime, with a few percent coal, and recirculated coal char. The bed operates at significantly lower temperatures, about 427° C (800° F), which thermodynamically favors low NO<sub>x</sub> formation

and SO<sub>2</sub> capture by reaction with CaO to form CaSO<sub>4</sub>. The steam cycle can be subcritical and potentially supercritical, as with PC combustion, and generating efficiencies are similar. The primary advantage of CFB technology is its capability to capture SO<sub>2</sub> in the bed, and its flexibility to a wide range of coal properties, including coals with low heating value, high-ash coals and low-volatile coals, and to changes in coal type during operation. Several new lignite-burning CFB units have been constructed recently, and CFBs are well suited to co-firing biomass [23].

The performance data for the CFB unit in Table 3.1 is based on lignite rather than Illinois # 6 coal. The lignite has a heating value of 17,400 kJ/kg and low sulfur. The coal feed rate is higher than for the other technologies because of the lower heating value of the lignite. Appendix 3.B gives a detailed process schematic for CFB generation.

### COAL TYPE AND QUALITY EFFECTS

Coal type and quality impact generating unit technology choice and design, generating efficiency, capital cost, performance, and COE (Appendix 3.A). Boiler designs today usually encompass a broader range of typical coals than initially intended to provide future flexibility. Single coal designs are mostly limited to mine-mouth plants, which today are usually only lignite, subbituminous, or brown coal plants. The energy, carbon, moisture, ash, and sulfur contents, as well as ash characteristics, all play an important role in the value and selection of coal, in its transportation cost, and in the technology choice for power generation. For illustration, Table 3.2 gives typical values and ranges for various coal properties as a function of coal type. Although most of the studies available are based on bituminous coals, a large fraction of the power generated in the U.S. involves Western subbituminous coals (>35%), such as Powder River Basin, because of its low sulfur content.

Each of these coal properties interacts in a significant way with generation technology to affect performance. For example, higher sulfur content reduces PC generating efficiency due to the added energy consumption and operating costs to remove SO<sub>x</sub> from the flue gas. High ash content requires PC design changes to manage erosion. High ash is a particular problem with Indian coals. Fluid-bed combustion is well suited to high-ash coals, low-carbon coal waste, and lignite. Several high-efficiency, ultra-supercritical and supercritical PC generating units have recently been commissioned in Germany burning brown coal or lignite, and several new CFB units have been constructed in Eastern Europe, the U.S., Turkey and India burning lignite and in Ireland burning peat[23, 24].

Coal types with lower energy content and higher moisture content significantly affect capital cost and generating efficiency. About 50% of U.S. coal is sub-bituminous or lignite. Using bituminous Pittsburgh #8 as the reference, PC units designed for Powder River Basin (PRB) coal and for Texas lignite have an estimated 14% and 24% higher capital cost respectively. Generating efficiency decreases but by a smaller percentage (Appendix 3.A, Figure A-3.A.3) [25]. However, the lower cost of coal types with lower heating value can offset the impact of this increased capital cost and decreased efficiency, thus, resulting in very little impact on COE. Using average 2004 mine-mouth coal prices and PC generation, the COE for Illinois #6, PRB, and Texas lignite is equal to or less than that for Pittsburgh #8 (Appendix 3.A, Figure A-3.A.4).

### U.S. CRITERIA POLLUTANT IMPACTS

Although coal-based power generation has a negative environmental image, advanced PC plants have very low emissions; and PC emissions control technology continues to improve and will improve further (Appendix 3.D). It is not clear when and where the ultimate limits of flue gas control will be reached. In the U.S., particulate removal, via electrostatic precipita-

**Table 3.2 Typical Properties of Characteristic Coal Types**

COAL TYPE	ENERGY CONTENT, kJ/kg [CARBON CONTENT, wt %]	MOISTURE, wt %	SULFUR, wt %	ASH, wt %
Bituminous*	27,900 (ave. consumed in U.S.) [67 %]	3 – 13	2 – 4	7 - 14
Sub-bituminous* (Powder River Basin)	20,000 (ave. consumed in U.S.) [49 %]	28 - 30	0.3–0.5	5 - 6
Lignite*	15,000 (ave. consumed in U.S.) [40 %]	30 - 34	0.6 - 1.6	7 - 16
Average Chinese Coal	19,000 - 25,000 [48 – 61 %]	3 - 23	0.4 – 3.7	28 - 33
Average Indian Coal	13,000 – 21,000 [30 – 50 %]	4 - 15	0.2 – 0.7	30 - 50

\* U.S. coal reserves are ~ 48 % anthracite & bituminous, ~37 % subbituminous, and ~ 15 % lignite (See Appendix 3-A, Figure A.2 for more details.)

tors (ESP) or fabric filters, is universally practiced with very high levels of removal (99.9%). Flue gas desulfurization has been added to less than one-third of U.S. coal-based generating capacity [2], and post-combustion NO<sub>x</sub> control is practiced on about 10% of the coal-based generating capacity.

The Clean Air Act (1990) set up a cap and trade system for SO<sub>x</sub> [26] and established emissions reductions guidelines for NO<sub>x</sub>. This has helped produce a 38% reduction in total SO<sub>x</sub> emissions over the last 30 years, while coal-based power generation grew by 90%. Total NO<sub>x</sub> emissions have been reduced by 25% over this period. Recent regulations, including NAAQS[27], the Clean Air Interstate Rule (CAIR) [28], and the Clean Air Mercury Rule (CAMR) [29] will require an additional 60% reduction in total SO<sub>x</sub> emissions and an additional 45% reduction in total NO<sub>x</sub> emissions nationally by 2020. During this period, coal-based generation is projected to grow about 35%. Mercury reduction initially comes with SO<sub>x</sub> abatement; additional, mandated reductions come after 2009. NAAQS have produced a situation in which permitting a new coal generating unit requires extremely low emissions of particulate matter (PM), SO<sub>x</sub>, and NO<sub>x</sub>, driven by the need to meet stringent, local air quality requirements, essentially independent of national emissions caps.

Newly permitted coal-fired PC units routinely achieve greater than 99.5% particulate control, and removal efficiencies greater than 99.9% are achievable at little additional cost. Wet flue-gas desulfurization (FGD) can achieve 95%

SO<sub>x</sub> removal without additives and 99% SO<sub>x</sub> removal with additives [30]. Selective catalytic reduction (SCR), combined with low-NO<sub>x</sub> combustion technology, routinely achieves 90+% NO<sub>x</sub> reduction over non-controlled emissions levels. New, advanced PC units in the U.S. are currently achieving criteria pollutant emissions reductions consistent with the performance outlined above and have emissions levels that are at or below the emissions levels achieved by the best PC units in Japan and Europe (Appendix 3.D).

Today, about 25% of the mercury in the coal burned is removed by the existing flue gas treatment technologies in place, primarily with the fly ash via electrostatic precipitators (ESP) or fabric filters. Wet FGD achieves 40-60% mercury removal; and when it is combined with SCR, mercury removal could approach 95% for bituminous coals [31]. For subbituminous coals, mercury removal is typically less than 40%, and may be significantly less for lignite, even when the flue gas clean-up technologies outlined above are in use. However, with activated carbon or brominated activated carbon injection removal rates can be increased to ~90% [31]. Optimization of existing technologies and new technology innovations can be expected to achieve > 90% mercury removal on most if not all coals within the next 10-15 years.

Table 3.3 gives the estimated incremental impact on the COE of the flue gas treatment technologies to meet the low emissions levels that are the design basis of this study, vs. a PC unit without controls. The impact of achieving these levels of control is about 1.0 ¢/kW<sub>e</sub>-h

**Table 3.3 Estimated Incremental Costs for a Pulverized Coal Unit to Meet Today’s Best Demonstrated Criteria Emissions Control Performance Vs. No Control**

	CAPITAL COST <sup>a</sup> [\$/kW <sub>e</sub> ]	O&M <sup>b</sup> [¢/kW <sub>e</sub> -h]	COE <sup>c</sup> [¢/kW <sub>e</sub> -h]
PM Control <sup>d</sup>	40	0.18	0.26
NO <sub>x</sub>	25 (50 – 90) <sup>e</sup>	0.10 (0.05 – 0.15)	0.15 (0.15 – 0.33)
SO <sub>2</sub>	150 (100 – 200) <sup>e</sup>	0.22 (0.20 – 0.25)	0.52 (0.40 – 0.65)
Incremental control cost	215	0.50	0.93 <sup>f</sup>

*a. Incremental capital costs for a typical, new-build plant to meet today's low emissions levels. Costs for low heating value coals will be somewhat higher*  
*b. O&M costs are for typical plant meeting today's low emissions levels. Costs will be somewhat higher for high-sulfur and low heating value coals.*  
*c. Incremental COE impact, bituminous coal*  
*d. Particulate control by ESP or fabric filter included in the base unit costs*  
*e. Range is for retrofits and depends on coal type, properties, control level and local factors*  
*f. When added to the "no-control" COE for SC PC, the total COE is 4.78 ¢/kW<sub>e</sub>-h*

or about 20% of the total COE from a highly-controlled PC unit. Although mercury control is not explicitly addressed here, removal should be in the 60-80% range for bituminous coals, including Illinois #6 coal, and less for subbituminous coals and lignite. We estimate that the incremental costs to meet CAIR and CAMR requirements and for decreasing the PM, SO<sub>x</sub>, and NO<sub>x</sub> emissions levels by a factor of 2 from the current best demonstrated emissions performance levels used for Table 3.3 would increase the cost of electricity by about an additional 0.22 ¢/kW<sub>e</sub>-h (Appendix 3.D, Table A-3D.4). The total cost of emissions control is still less than 25% of the cost of the electricity produced. Meeting the Federal 2015 emissions levels is not a question of control technology capabilities but of uniform application of current technology. Meeting local emissions requirements may be a different matter.

### PULVERIZED COAL COMBUSTION GENERATING TECHNOLOGY: WITH CO<sub>2</sub> CAPTURE

CO<sub>2</sub> capture with PC combustion generation involves CO<sub>2</sub> separation and recovery from the flue gas, at low concentration and low partial pressure. Of the possible approaches to separation [32], chemical absorption with amines, such as monoethanolamine (MEA) or hindered amines, is the commercial process

of choice [33, 34]. Chemical absorption offers high capture efficiency and selectivity for air-blown units and can be used with sub-, super-, and ultra-supercritical generation as illustrated in Figure 3.4 for a subcritical PC unit. The CO<sub>2</sub> is first captured from the flue gas stream by absorption into an amine solution in an absorption tower. The absorbed CO<sub>2</sub> must then be stripped from the amine solution via a temperature increase, regenerating the solution for recycle to the absorption tower. The recovered CO<sub>2</sub> is cooled, dried, and compressed to a supercritical fluid. It is then ready to be piped to storage.

CO<sub>2</sub> removal from flue gas requires energy, primarily in the form of low-pressure steam for the regeneration of the amine solution. This reduces steam to the turbine and the net power output of the generating plant. Thus, to maintain constant net power generation the coal input must be increased, as well as the size of the boiler, the steam turbine/generator, and the equipment for flue gas clean-up, etc. Absorption solutions that have high CO<sub>2</sub> binding energy are required by the low concentration of CO<sub>2</sub> in the flue gas, and the energy requirements for regeneration are high.

A subcritical PC unit with CO<sub>2</sub> capture (Figure 3.4), that produces 500 MW<sub>e</sub> net power, requires a 37% increase in plant size and in coal feed rate (76,000 kg/h more coal) vs. a



**Figure 3.4 Subcritical 500 MW<sub>e</sub> Pulverized Coal Unit with CO<sub>2</sub> Capture**

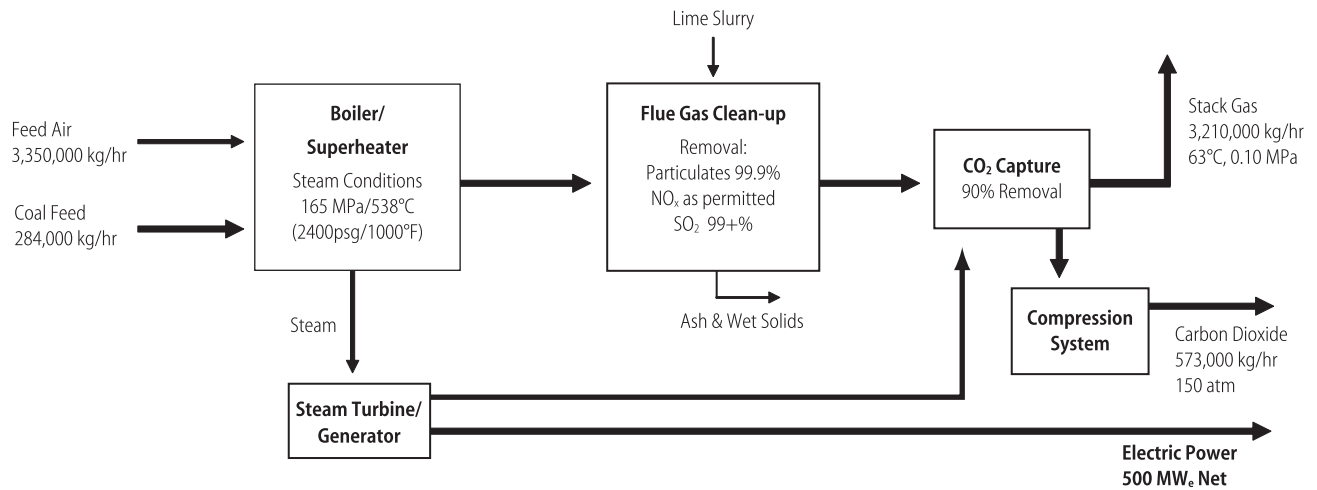

500 MW<sub>e</sub> unit without CO<sub>2</sub> capture (Figure 3.2). The generating efficiency is reduced from 34.3% to 25.1% (Table 3.1). The primary factors in efficiency reduction associated with addition of CO<sub>2</sub> capture are illustrated in Figure 3.5. The thermal energy required to recover CO<sub>2</sub> from the amine solution reduces the efficiency by 5 percentage points. The energy required to compress the CO<sub>2</sub> from 0.1 MPa to about 15 MPa (to a supercritical fluid) is the next largest factor, reducing the efficiency by 3.5 percentage points. All other energy requirements amount to less than one percentage point.

An ultra-supercritical PC unit with CO<sub>2</sub> capture (Figure 3.6) that produces the same net power output as an ultra-supercritical PC unit without CO<sub>2</sub> capture (Figure 3.3) requires a 27% increase in unit size and in coal feed rate (44,000 kg/h more coal). Figure 3.7 illustrates the main factors in efficiency reduction associated with addition of CO<sub>2</sub> capture to an ultra-supercritical PC unit. The overall efficiency reduction is 9.2 percentage points in both cases, but the ultra-supercritical, non-capture unit starts at a sufficiently high efficiency that with CO<sub>2</sub> capture, its efficiency is essentially the same as that of the subcritical unit without CO<sub>2</sub> capture.

**Figure 3.5 Parasitic Energy Requirements for a Subcritical Pulverized Coal Unit With Post-Combustion CO<sub>2</sub> Capture**

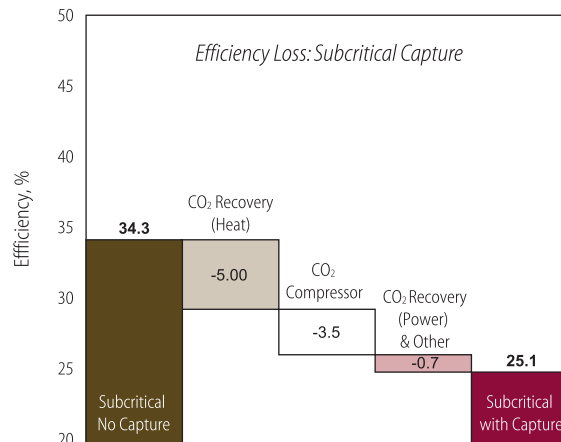

**COST OF ELECTRICITY FOR AIR-BLOWN PULVERIZED COAL COMBUSTION**

The cost of electricity (COE), without and with CO<sub>2</sub> capture, was developed for the competing technologies analyzed in this report through a detailed evaluation of recent design studies, combined with expert validation. Appendix 3.C lists the studies that formed the basis for our report (Table A-3.C.2), provides more detail on each, and details the approach used. The largest and most variable component of COE among the studies is the capital charge, which is dependent on the total plant (or unit) cost (TPC) and the cost of capital. Figure 3.8 shows

**Figure 3.6 Ultra-Supercritical 500 MW<sub>e</sub> Pulverized Coal Unit with CO<sub>2</sub> Capture**

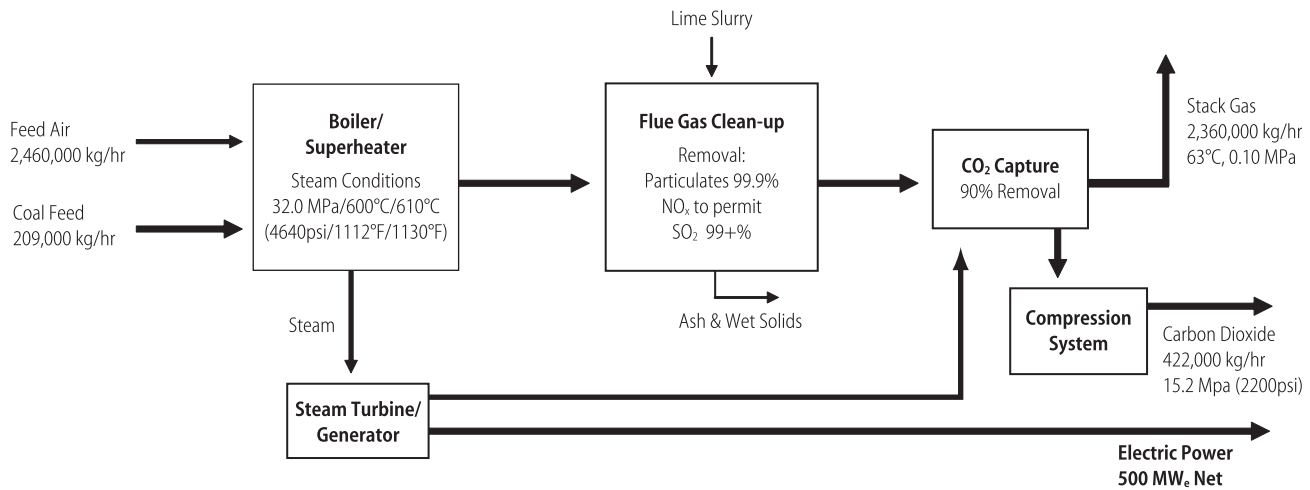

the min, max, and mean of the estimated TPC for each technology expressed in 2005 dollars. Costs are for a 500 MW<sub>e</sub> plant and are given in \$/kW<sub>e</sub> net generating capacity.

In addition to the variation in TPC, each of these studies used different economic and operating parameter assumptions resulting in a range in the capital carrying cost, in the O&M cost, and in the fuel cost. The differences in these assumptions among the studies account for much of the variability in the reported COE. The COE from these studies is shown in Figure 3.9, where the “as-reported” bars show the min, max, and mean in the COE for the different technologies as reported in the stud-

ies in the dollars of the study year. Appendix 3.C provides more detail.

To compare the studies on a more consistent basis, we recalculated the COE for each of the studies using the normalized economic and operating parameters listed in Table 3.4. O&M costs are generally considered to be technology and report-specific and were not changed in this analysis. Other factors that contribute to variation include regional material and labor costs, and coal quality impacts. The “normalized” bars in Figure 3.9 summarize the results of this analysis of these design studies.

The variation in “as-reported” COE for non-capture PC combustion is small because of the broad experience base for this technology. Significant variation in COE exists for the CO<sub>2</sub> capture cases due to the lack of commercial data. The normalized COE values are higher for most of the cases because we used a higher fuel price and put all cost components in 2005 dollars.

To develop the COE values for this report, we took the TPC numbers from the design studies (Figure 3.8), adjusted them to achieve internal consistency (e.g. SubC PC<SC PC<USC PC), then compared our TPC numbers with industry consensus group numbers [35] and made secondary adjustments based on ratios and deltas from these numbers. This produced the TPC values in Table 3.1. Using these TPC

**Figure 3.7 Parasitic Energy Requirements for an Ultra-Supercritical Pulverized Coal Unit with Post-Combustion CO<sub>2</sub> Capture**

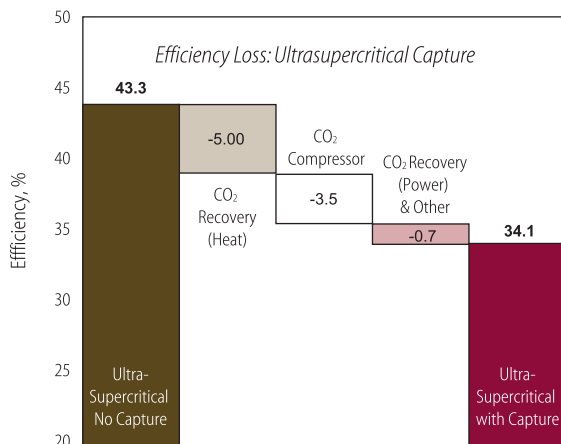

numbers, the parameters in Table 3.4, and estimated O&M costs, we calculated the COE for each technology, and these are given in Table 3.1.

Total plant costs shown above and in Table 3.1 were developed during a period of price stability [2000-2004] and were incremented by CPI inflation to 2005\$. These costs and the deltas among them were well vetted, broadly accepted, and remain valid in comparing costs of different generating technologies. However, significant cost inflation from 2004 levels due to increases in engineering and construction costs including labor, steel, concrete and other consumables used for power plant construction, has been between 25 and 30%. Thus, a SCPC unit with an estimated capital cost of \$1330 (Table 3.1) is now projected at \$1660 to \$1730/ kW<sub>e</sub> in 2007\$. Because we have no firm data on how these cost increases will affect the cost of the other technologies evaluated in this report, the discussion that follows is based on the cost numbers in Table 3.1, which for relative comparison purposes remain valid.

For PC generation without CO<sub>2</sub> capture, the COE decreases from 4.84 to 4.69 ¢/kW<sub>e</sub>-h from subcritical to ultra-supercritical technology because efficiency gains outweigh the additional capital cost (fuel cost component decreases faster than the capital cost component increases). Historically, coal cost in the U.S. has been low enough that the economic choice has been subcritical PC. The higher coal costs in Europe and Japan have driven the choice of higher-efficiency generating technologies, supercritical and more recently ultra-supercritical. For the CFB case, the COE is similar to that for the PC cases, but this is because cheaper lignite is the feed, and emissions control is less costly. The CFB design used here does not achieve the very low criteria emissions achieved by our PC design. For Illinois #6 and comparable emissions limits, the COE for the CFB would be significantly higher.

The increase in COE in going from no-capture to CO<sub>2</sub> capture ranges from 3.3 ¢/kW<sub>e</sub>-h for subcritical generation to 2.7 ¢/kW<sub>e</sub>-h for ultra-

**Figure 3.8 Total Plant Cost for Air-Blown Coal Combustion Power Generation Technologies from Recent Design Studies. The Min, Max, and Mean (2005 Dollars) Are Shown When Multiple Studies Evaluated a Given Technology.**

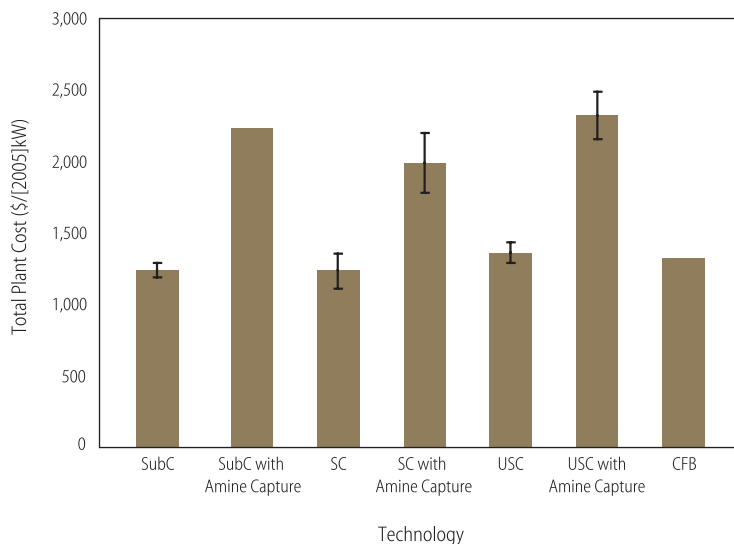
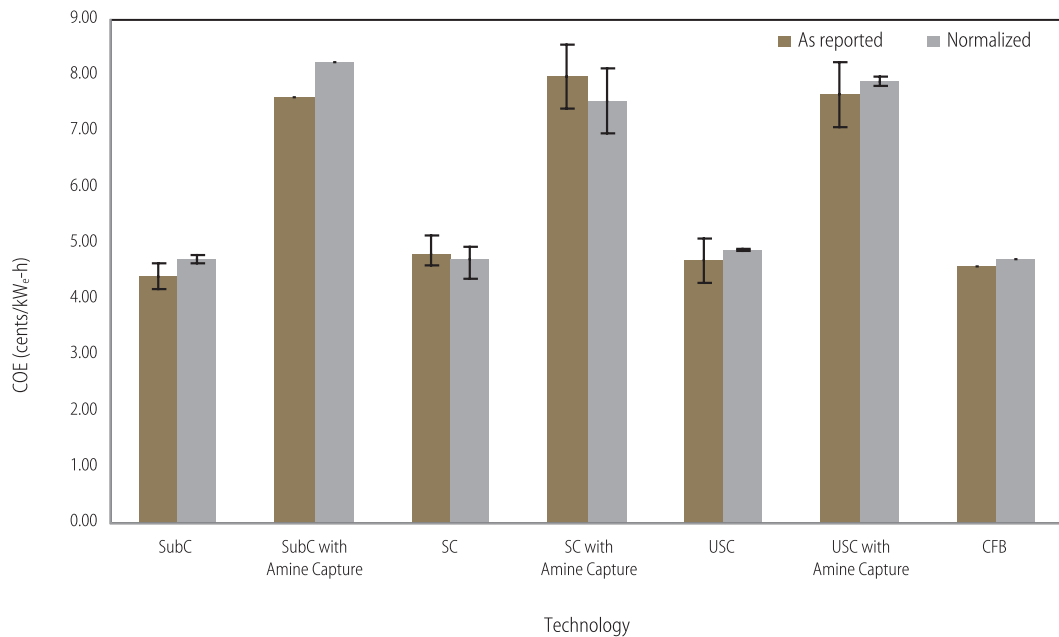

Table 3.4 Economic and Operating Parameters	
PARAMETER	VALUE
Capacity factor	85%
Carrying charge factor	15.1%
Fuel cost	\$1.50 / MMBtu (HHV)
Total capital requirement (TCR)	12% higher than total plant cost
Life of plant	20 years
Cost year basis	2005
Tax rate	39.2%

supercritical generation (Table 3.1). Over half of this increase is due to higher capital carrying charge resulting from the increased boiler and steam turbine size and the added CO<sub>2</sub> capture, recovery, and compression equipment. About two thirds of the rest is due to higher O&M costs associated with the increased operational scale per kW<sub>e</sub> and with CO<sub>2</sub> capture and recovery. For air-blown PC combustion technologies, the cost of avoided CO<sub>2</sub> is about \$41 per tonne. These costs are for capture, compression and drying, and do not include the pipeline, transportation and sequestration costs.

The largest cause of the efficiency reduction observed with CO<sub>2</sub> capture for air-blown PC generation (Figure 3.5 and 3.7) is the energy

**Figure 3.9 Cost of Electricity from Design Studies As-Reported and Using Normalized Economic and Operating Parameters for Air-Blown Coal Combustion Generating Technologies. Min, Max, and Mean (2005\$) for Multiple Studies.**



required to regenerate the amine solution (recovering the CO<sub>2</sub>), which produces a 5 percentage point efficiency reduction. If this component could be reduced by 50% with an efficient, lower-energy capture technology, the COE for supercritical capture would be reduced by about 0.5 ¢/kW<sub>e</sub>-h to about 7.2 ¢/kW<sub>e</sub>-h and by about 0.4 ¢/kW<sub>e</sub>-h for ultra-supercritical generation. This would reduce the CO<sub>2</sub> avoided cost to about \$30 per tonne, a reduction of over 25%.

### RETROFITS FOR CO<sub>2</sub> CAPTURE

Because of the large coal-based PC generating fleet in place and the additional capacity that will be constructed in the next two decades, the issue of retrofitting for CO<sub>2</sub> capture is important to the future management of CO<sub>2</sub> emissions. For air-blown PC combustion units, retrofit includes the addition of a process unit to the back end of the flue-gas system to separate and capture CO<sub>2</sub> from the flue gas, and to dry and compress the CO<sub>2</sub> to a supercritical fluid, ready for transport and sequestration. Since the existing coal fleet consists of primarily

subcritical units, another option is to rebuild the boiler/steam system, replacing it with high efficiency supercritical or ultra-supercritical technology, including post-combustion CO<sub>2</sub> capture. Appendix 3.E provides a more-detailed analysis of retrofits and rebuilds.

For an MEA retrofit of an existing subcritical PC unit, the net electrical output can be derated by over 40%, e.g., from 500 MW<sub>e</sub> to 294 MW<sub>e</sub> [36]. In this case, the efficiency decrease is about 14.5 percentage points (Appendix 3.E) compared to about 9.2 percentage points for purpose-built subcritical PC units, one no-capture and the other capture (Table 3.1). With the retrofit, the steam required to regenerate the absorbing solution to recover the CO<sub>2</sub> (Figure 3.4), unbalances the rest of the plant so severely that the efficiency is reduced another 4 to 5 percentage points. In the retrofit case, the original boiler is running at full design capacity, but the original steam turbine is operating at about 60% design rating, which is well off its efficiency optimum. Due to the large power output reduction (41% derating), the retrofit capital cost is estimated to be \$1600 per kW<sub>e</sub> [36]. This was for a specific

unit with adequate space; however, retrofit costs are expected to be highly dependent on location and unit specifics. If the original unit is considered fully paid off, we estimate the COE after retrofit could be slightly less than that for a new purpose-built PC unit with CO<sub>2</sub> capture. However, an operating plant will usually have some residual value, and the reduction in unit efficiency and output, increased on-site space requirements and unit downtime are all complex factors not fully accounted for in this analysis. Based on our analysis, we conclude that retrofits seem unlikely.

Another approach, though not a retrofit, is to rebuild the core of a subcritical PC unit, installing supercritical or ultra-supercritical technology along with post-combustion CO<sub>2</sub> capture. Although the total capital cost for this approach is higher, the cost/kW<sub>e</sub> is about the same as for a subcritical retrofit. The resultant plant efficiency is higher, consistent with that of a purpose-built unit with capture; the net power output can essentially be maintained; and the COE is about the same due to the overall higher efficiency. We estimate that an ultra-supercritical rebuild with MEA capture will have an efficiency of 34% and produce electricity for 6.91 ¢/kW<sub>e</sub>-h (Appendix 3.E). We conclude that rebuilds including CO<sub>2</sub> capture appear more attractive than retrofits, particularly if they upgrade low-efficiency PC units with high-efficiency technology, including CO<sub>2</sub> capture.

**CAPTURE-READY** A unit can be considered capture-ready if, at some point in the future, it can be retrofitted for CO<sub>2</sub> capture and sequestration and still be economical to operate [37]. Thus, capture-ready design refers to designing a new unit to reduce the cost of and to facilitate adding CO<sub>2</sub> capture later or at least to not preclude addition of capture later. Capture-ready has elements of ambiguity associated with it because it is not a specific design, but includes a range of investment and design decisions that might be undertaken during unit design and construction. Further, with an uncertain future policy environment, significant pre-investment for CO<sub>2</sub> capture is typi-

cally not economically justified [38]. However, some actions make sense. Future PC plants should employ the highest economically efficient technology and leave space for future capture equipment if possible, because this makes retrofits more attractive. Siting should consider proximity to geologic storage.

## OXYGEN-BLOWN COAL-BASED POWER GENERATION

The major problems with CO<sub>2</sub> capture from air-blown PC combustion are due to the need to capture CO<sub>2</sub> from flue gas at low concentration and low partial pressure. This is mainly due to the large amount of nitrogen in the flue gas, introduced with the combustion air. Another approach to CO<sub>2</sub> capture is to substitute oxygen for air, essentially removing most of the nitrogen. We refer to this as oxy-fuel PC combustion. A different approach is to gasify the coal and remove the CO<sub>2</sub> prior to combustion. Each of these approaches has advantages and disadvantages, but each offers opportunities for electricity generation with reduced CO<sub>2</sub>-capture costs. We consider these approaches next in the form of oxy-fuel PC combustion and Integrated Gasification Combined Cycle (IGCC) power generation.

Table 3.5 summarizes representative performance and economics for oxygen-blown coal-based power generation technologies. Oxy-fuel combustion and IGCC were evaluated using the same bases and assumptions used for the PC combustion technologies (Table 3.1). In this case the estimates are for the N<sup>th</sup> unit or plant where N is a relatively small number, < 10. In this report, we use gasification and IGCC to mean oxygen-blown gasification or oxygen-blown IGCC. If we mean air-blown gasification, it will be explicitly stated.

## OXY-FUEL PULVERIZED COAL (PC) COMBUSTION

This approach to capturing CO<sub>2</sub> from PC units involves burning the coal with ~95%

**Table 3.5 Representative Performance and Economics for Oxy-Fuel Pulverized Coal and IGCC Power Generation Technologies, Compared with Supercritical Pulverized Coal**

	SUPERCRITICAL PC		SC PC-OXY	IGCC	
	W/O CAPTURE	W/ CAPTURE	W/CAPTURE	W/O CAPTUREQ	W/CAPTURE
<b>PERFORMANCE</b>					
Heat rate (1), Btu/kW <sub>e</sub> -h	8,868	11,652	11,157	8,891	10,942
Generating efficiency (HHV)	38.5%	29.3%	30.6%	38.4%	31.2%
Coal feed, kg/h	184,894	242,950	232,628	185,376	28,155
CO <sub>2</sub> emitted, kg/h	414,903	54,518	52,202	415,983	51,198
CO <sub>2</sub> captured at 90%, kg/h (2)	0	490,662	469,817	0	460,782
CO <sub>2</sub> emitted, g/kW <sub>e</sub> -h (2)	830	109	104	832	102
<b>COSTS</b>					
Total Plant Cost (3), \$/kW <sub>e</sub>	1,330	2,140	1,900	1,430	1,890
Inv.Charge, ¢/kW <sub>e</sub> -h @ 15.1% (4)	2.70	4.34	3.85	2.90	3.83
Fuel, ¢/kW <sub>e</sub> -h @ \$1.50/MMBtu	1.33	1.75	1.67	1.33	1.64
O&M, ¢/kW <sub>e</sub> -h	0.75	1.60	1.45	0.90	1.05
<b>COE, ¢/kW<sub>e</sub>-h</b>	<b>4.78</b>	<b>7.69</b>	<b>6.98</b>	<b>5.13</b>	<b>6.52</b>
<b>Cost of CO<sub>2</sub> avoided vs. same technology w/o capture (5), \$/tonne</b>		<b>40.4</b>	<b>30.3</b>		<b>19.3</b>
<b>Cost of CO<sub>2</sub> avoided vs. supercritical technology w/o capture (5), \$/tonne</b>		<b>40.4</b>	<b>30.3</b>		<b>24.0</b>
<p><b>Basis:</b> 500 MW<sub>e</sub> plant net output, Illinois # 6 coal (61.2 wt % C, HHV = 25,350 kJ/kg), &amp; 85% capacity factor; for oxy-fuel SC PC CO<sub>2</sub> for sequestration is high purity; for IGCC, GE radiant cooled gasifier for no-capture case and GE full-quench gasifier for capture case.</p> <p>(1) efficiency = (3414 Btu/kW<sub>e</sub>-h)/(heat rate)</p> <p>(2) 90% removal used for all capture cases</p> <p>(3) Based on design studies done between 2000 &amp; 2004, a period of cost stability, updated to 2005\$ using CPI inflation rate. Refers to the N<sup>th</sup> plant where N is less than 10. 2007 cost would be higher because of recent rapid increases of engineering and construction costs, up to 30% since 2004.</p> <p>(4) Annual carrying charge of 15.1% from EPRI-TAG methodology, based on 55% debt @ 6.5%, 45% equity @ 11.5%, 39.2% tax rate, 2% inflation rate, 3 year construction period, 20 year book life, applied to total plant cost to calculate investment charge</p> <p>(5) Does not include costs associated with transportation and injection/storage</p>					

pure oxygen instead of air as the oxidant [39-41]. The flue gas then consists mainly of carbon dioxide and water vapor. Because of the low concentration of nitrogen in the oxidant gas (95% oxygen), large quantities of flue gas are recycled to maintain design temperatures and required heat fluxes in the boiler, and dry coal-ash conditions. Oxy-fuel enables capture of CO<sub>2</sub> by direct compression of the flue gas but requires an air-separation unit (ASU) to supply the oxygen. The ASU energy consumption is the major factor in reducing the efficiency of oxy-fuel PC combustion. There are no practical reasons for applying oxy-fuel except for CO<sub>2</sub> capture.

A block diagram of a 500 MW<sub>e</sub> oxy-fuel generating unit is shown in Figure 3.10 with key material flows shown. Boiler and steam cycle are supercritical. The coal feed rate is higher than that for supercritical PC without capture because of the power consumption of the air separation unit but lower than that for a supercritical PC with MEA CO<sub>2</sub> capture (Table 3.1). In this design, wet FGD is used prior to recycle to remove 95% of the SO<sub>x</sub> to avoid boiler corrosion problems and high SO<sub>x</sub> concentration in the downstream compression/separation equipment. Non-condensables are removed from the compressed flue gas via a two-stage flash. The composition requirements (purity) of the CO<sub>2</sub> stream for transport and geological injection are yet to be established. The

**Figure 3.10 500 MW<sub>e</sub> Supercritical Oxy-Fuel Generating Unit with CO<sub>2</sub> Capture**

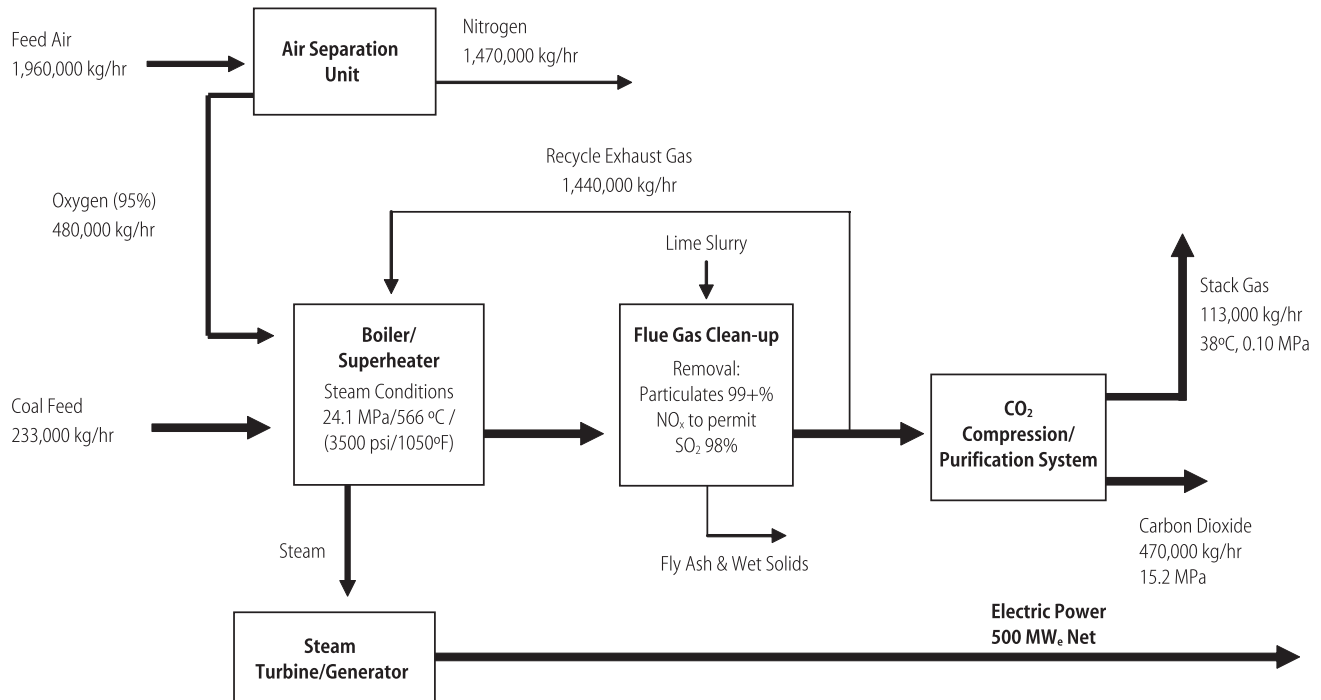

generating efficiency is 30.6% (HHV), which is about 1 percentage point higher than supercritical PC with MEA CO<sub>2</sub> capture. Current design work suggests that the process can be further simplified with SO<sub>x</sub> and NO<sub>x</sub> removal occurring in the downstream compression & separation stage at reduced cost [42]. Further work is needed.

Figure 3.11 shows the parasitic energy requirements for oxy-fuel PC generation with CO<sub>2</sub> capture. Since the steam cycle is supercritical for the oxy-fuel case, supercritical PC is used as the comparison base. The oxy-fuel PC unit has a gain over the air-driven PC case due to improved boiler efficiency and reduced emissions control energy requirements, but the energy requirement of the ASU, which produces a 6.4 percentage point reduction, outweighs this efficiency improvement. The overall efficiency reduction is 8.3 percentage points from supercritical PC. More efficient oxygen separation technology would have a significant impact.

A key unresolved issue is the purity requirements of the supercritical CO<sub>2</sub> stream for geo-

logical injection (sequestration). Our design produces a highly-pure CO<sub>2</sub> stream, similar to that from the PC capture cases, but incurs additional cost to achieve this purity level. If this additional purification were not required for transport and geologic sequestration of the CO<sub>2</sub>, oxy-fuel PC combustion could gain up to one percentage point in efficiency, and the COE could be reduced by up to 0.4 ¢/kW<sub>e</sub>-h.

Oxy-fuel PC combustion is in early commercial development but appears to have considerable potential. It is under active pilot-scale development [43, 44]; Vattenfall plans a 30 MW<sub>th</sub> CO<sub>2</sub>-free coal combustion plant for 2008 start-up[43]; Hamilton, Ontario is developing a 24 MW<sub>e</sub> oxy-fuel electricity generation project [45]; and other projects can be expected to be announced.

**ECONOMICS** Because there is no commercial experience with oxy-fuel combustion and lack of specificity on CO<sub>2</sub> purity requirements for transport and sequestration in a future regulatory regime, the TPC in the limited design studies ranged broadly [13, 39, 41, 46] (Appendix 3.C, Table A-3.C.2, Figure A-3.C.1).

**Figure 3.11 Parasitic Energy Requirement for Oxy-Fuel Pulverized Coal Generation with CO<sub>2</sub> Capture Vs. Supercritical PC without CO<sub>2</sub> Capture**

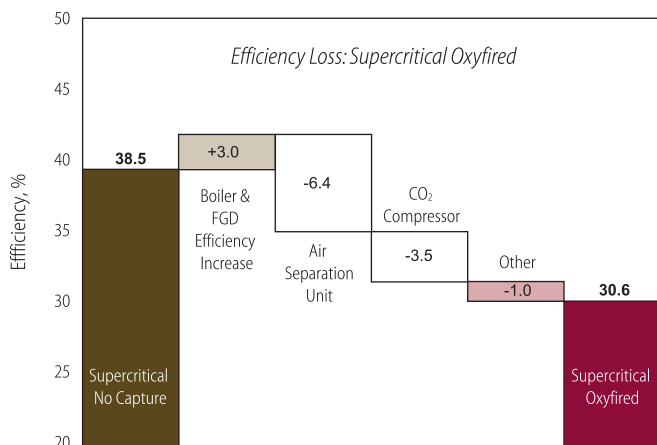

Only the Parsons study estimated the COE [13]. As with PC combustion, we reviewed the available design studies (Appendix 3.C), our plant component estimate of costs, and external opinion of TPC to arrive at a projected TPC (Table 3.5). We estimated generating efficiency to be 30.6% from the Integrated Environmental Control Model[5]. We applied our normalization economic and operating parameters (Table 3.4) to calculate a COE of 6.98 ¢/kW<sub>e</sub>-h (Table 3.5). There may be some upside potential in these numbers if supercritical CO<sub>2</sub> stream purity can be relaxed and design efficiencies gained, but more data are needed.

**RETROFITS** Oxy-fuel is a good option for retrofitting PC and FBC units for capture since the boiler and steam cycle are less affected by an oxy-fuel retrofit; the major impact being an increased electricity requirement for the auxiliaries, particularly the ASU. Bozzuto estimated a 36% derating for an oxy-fuel retrofit vs. a 41% derating for MEA capture on the same unit [36]. In summary, the oxy-fuel retrofit option costs about 40% less on a \$/kW<sub>e</sub> basis, is projected to produce electricity at 10% to 15% less than an MEA retrofit, and has a significantly lower CO<sub>2</sub> avoidance cost (Appendix 3.E). Oxy-fuel rebuild to improve efficiency is another option and appears to be competitive with a high-efficiency MEA rebuild [47].

### INTEGRATED GASIFICATION COMBINED CYCLE (IGCC)

Integrated gasification combined cycle (IGCC) technology produces electricity by first gasifying coal to produce syngas, a mixture of hydrogen and carbon monoxide[48, 49]. The syngas, after clean-up, is burned in a gas turbine which drives a generator. Turbine exhaust goes to a heat recovery generator to raise steam which drives a steam turbine generator. This combined cycle technology is similar to the technology used in modern natural gas fired combined-cycle power plants. Appendix 3.B provides more detail on gasification.

The key component in IGCC is the gasifier, for which a number of different technologies have been developed and are classified and summarized in Table 3.6.

Gasifier operating temperature depends on whether the ash is to be removed as a solid, dry ash or as a high-temperature liquid (slag). Outlet temperature depends on the flow regime and extent of mixing in the gasifier. For the current IGCC plants, oxygen-blown, entrained-flow gasifiers are the technology of choice, although other configurations are being evaluated.

Four 275 to 300 MW<sub>e</sub> coal-based IGCC demonstration plants, which are all in commercial operation, have been built in the U.S. and in Europe, each with government financial support [50][33]. Five large IGCC units (250 to 550 MW<sub>e</sub>) are operating in refineries gasifying asphalt and refinery wastes [51, 52]; a smaller one (180 MW<sub>e</sub>) is operating on petroleum coke. The motivation for pursuing IGCC is the potential for better environmental performance at a lower marginal cost, easier CO<sub>2</sub> capture for sequestration, and higher efficiency. However, the projected capital cost (discussed below) and operational availability of today's IGCC technology make it difficult to compete with conventional PC units at this time.



**Table 3.6 Classification and Characteristics of Gasifiers**

	MOVING BED	FLUID BED	ENTRAINED FLOW
Outlet temperature	Low (425-600 °C)	Moderate (900-1050 °C)	High (1250-1600 °C)
Oxidant demand	Low	Moderate	High
Ash conditions	Dry ash or slagging	Dry ash or agglomerating	Slagging
Size of coal feed	6-50 mm	6-10 mm	< 100 µm
Acceptability of fines	Limited	Good	Unlimited
Other characteristics	Methane, tars and oils present in syngas	Low carbon conversion	Pure syngas, high carbon conversion

**IGCC: WITHOUT CO<sub>2</sub> CAPTURE**

There are several commercial gasifiers which can be employed with IGCC [53] (see Appendix 3.B for details). A block diagram of a 500 MW<sub>e</sub> IGCC unit using a radiant cooling/quench gasifier is shown in Figure 3.12. Finely ground coal, either dry or slurried with water, is introduced into the gasifier, which is operated at pressures between 3.0 and 7.1 MPa (440 to 1050 psi), along with oxygen and water. Oxygen is supplied by an air separation unit (ASU). The coal is partially oxidized raising the temperature to between 1340 and 1400 °C. This assures complete carbon conversion by rapid reaction with steam to form an equilibrium gas mixture that is largely hydrogen and carbon monoxide (syngas). At this temperature, the coal mineral matter melts to form a free-flowing slag. The raw syngas exits the gasification unit at pressure and relatively high

temperature, with radiative heat recovery raising high-pressure steam. Adequate technology does not exist to clean-up the raw syngas at high temperature. Instead, proven technologies for gas clean-up require near-ambient temperature. Thus, the raw syngas leaving the gasifier can be quenched by injecting water, or a radiant cooler, and/or a fire-tube (convective) heat exchanger may be used to cool it to the required temperature for removal of particulate matter and sulfur.

The clean syngas is then burned in the combustion turbine. The hot turbine exhaust gas is used to raise additional steam which is sent to the steam turbine in the combined-cycle power block for electricity production. For the configuration shown (See Box 3.1), the overall generating efficiency is 38.4% (HHV), but coal and gasifier type will impact this number.

**Figure 3.12 500 MW<sub>e</sub> IGCC Unit without CO<sub>2</sub> Capture**

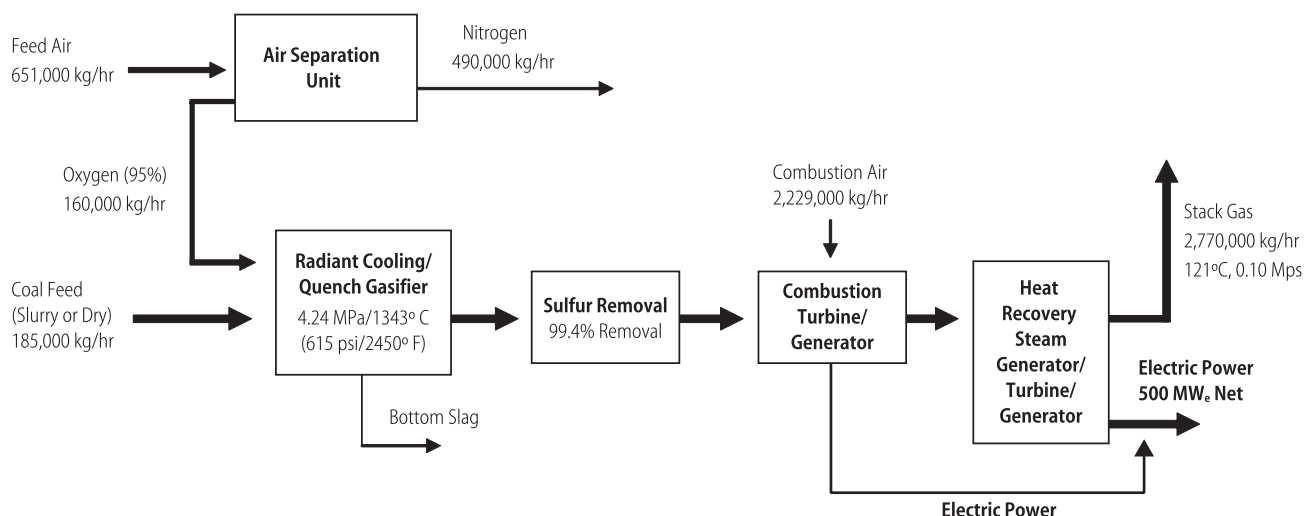

### BOX 3.1 IGCC DEMONSTRATIONS

The Cool Water Project sponsored by Southern California Edison in cooperation with GE and Texaco pioneered IGCC with support from the Synthetic Fuels Corporation. This plant demonstrated the feasibility of using IGCC to generate electricity. The plant operated periodically from 1984–1989, and cost over \$2000 /kW<sub>e</sub>. The project was eventually abandoned, but it provided the basis for the Tampa Electric Polk Power Station. The DOE supported the 250 MW<sub>e</sub> Polk Station commercial IGCC demonstration unit, using a Texaco gasifier, which started up in 1996. The total plant cost was about \$1800/kW<sub>e</sub>. Since it was the first commercial-scale IGCC plant, several optional systems were added, such as a hot-gas clean-up system, which were never used, and were later simplified or removed. When these changes are taken into account, the adjusted total plant cost has been estimated at \$1650/kW<sub>e</sub> (2001\$). This experience has led to some optimism that costs will come down significantly with economies of scale, component standardization, and technical and design advances. However, price increases will raise the nominal cost of plant capital significantly.

The availability of these early IGCC plants was low for the first several years of operation due to a range of problems, as shown in the figure. Many of the problems were design and materials related

Figure Box 3.1 IGCC Availability History (excluding operation on back-up fuel)

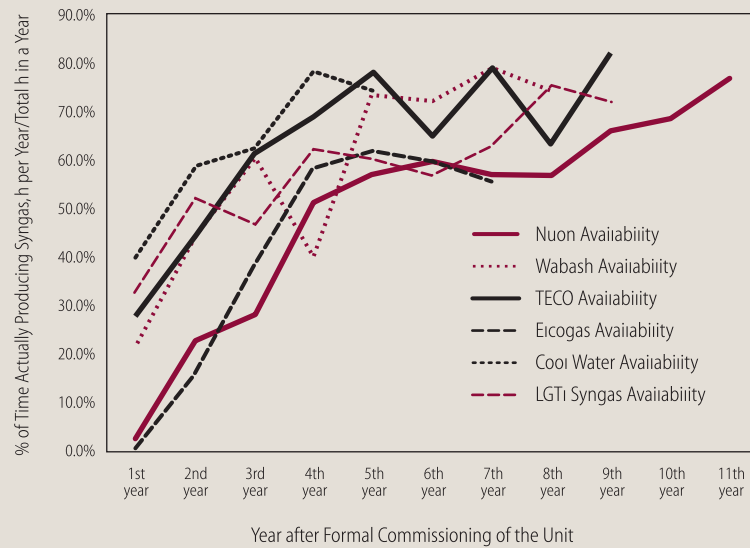

Graph provided by Jeff Phillips, EPRI [24]

which were corrected and are unlikely to reappear; others are process related, much like running a refinery, but all eventually proved to be manageable. Gasifier availability is now 82+% and operating efficiency is ~35.4%. DOE also supported the Wabash River Gasification Repowering Project, an IGCC demonstration project using the Dow E-gas gasifier. This demonstration started up in late 1995, has 262 MW<sub>e</sub> capacity, and an efficiency of ~38.4%. Start-up history was similar to that of the Polk unit. LGTI provided the basis for Wabash.

### IGCC: WITH PRE-COMBUSTION CO<sub>2</sub> CAPTURE

Applying CO<sub>2</sub> capture to IGCC requires three additional process units: shift reactors, an additional CO<sub>2</sub> separation process, and CO<sub>2</sub> compression and drying. In the shift reactors, CO in the syngas is reacted with steam over a catalyst to produce CO<sub>2</sub> and hydrogen. Because the gas stream is at high pressure and has a high CO<sub>2</sub> concentration, a weakly CO<sub>2</sub>-binding physical solvent, such as the glymes in Selexol, can be used to separate out the CO<sub>2</sub>. Reducing the pressure releases the CO<sub>2</sub> and regenerates the solvent, greatly reducing the energy requirements for CO<sub>2</sub> capture and recovery compared to the MEA system. Higher pressure in the gasifier improves the energy efficiency of both the separation and CO<sub>2</sub> compression steps. The gas stream to the turbine is

now predominantly hydrogen, which requires turbine modifications for efficient operation.

The block diagram with key material flows for a 500 MW<sub>e</sub> IGCC unit designed for CO<sub>2</sub> capture is shown in Figure 3.13. For CO<sub>2</sub> capture, a full-quench gasifier is currently considered the optimum configuration. The overall generating efficiency is 31.2% which is a 7.2 percentage point reduction from the IGCC system without CO<sub>2</sub> capture. Adding CO<sub>2</sub> capture requires a 23% increase in the coal feed rate. This compares with coal feed rate increases of 27% for ultra-supercritical PC and 37% for subcritical PC when MEA CO<sub>2</sub> capture is used.

Figure 3.14 illustrates the major impacts on efficiency of adding CO<sub>2</sub> capture to IGCC. CO<sub>2</sub> compression and water gas shift each have

**Figure 3.13 500 MW<sub>e</sub> IGCC Unit with CO<sub>2</sub> Capture**

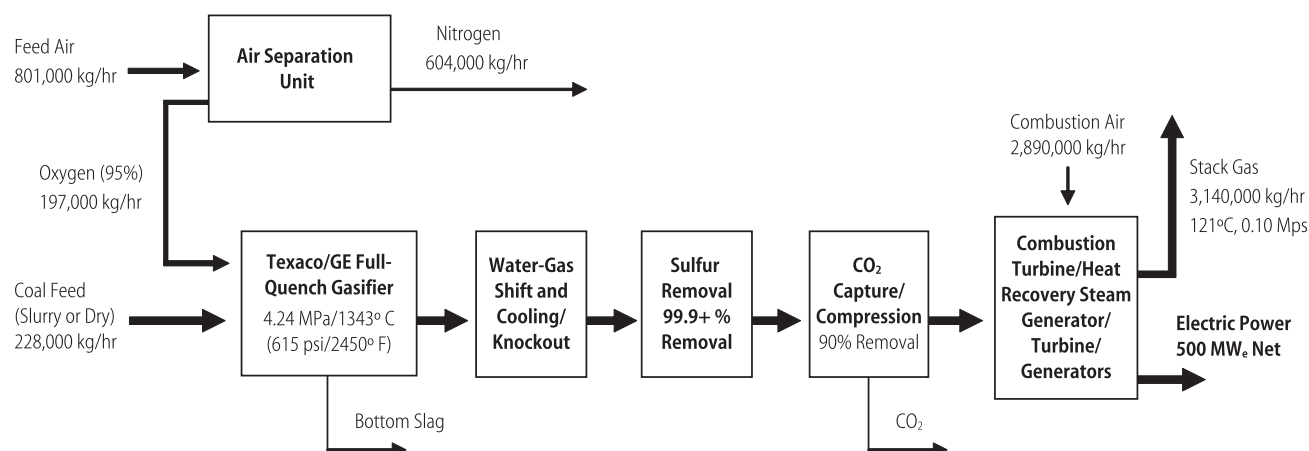

significant impacts. CO<sub>2</sub> compression is about two-thirds that for the PC cases because the CO<sub>2</sub> is recovered at an elevated pressure. Energy is required in the form of steam for shift reaction. The energy required for CO<sub>2</sub> recovery is lower than for the PC case because of the higher pressures and higher CO<sub>2</sub> concentrations, resulting in less energy intensive separation processes. The total efficiency reduction for IGCC is 7.2 percentage points as compared with 9.2 percentage points for the PC cases. This smaller delta between the no-capture and the capture cases is one of the attractive features of IGCC for application to CO<sub>2</sub> capture.

**COST OF ELECTRICITY** We analyzed the available IGCC design studies, without and with CO<sub>2</sub> capture, just as we did for PC generation, to arrive at a TPC and our estimate of the COE (Appendix 3.C). There was considerable variation (~\$400/kW<sub>e</sub> from min to max) in the TPC from the design studies for both no-capture and capture cases as shown in Figure A-3.C.2 (Appendix 3.C). Each estimate is for a 500 MW<sub>e</sub> plant and includes the cost of a spare gasifier. This variation is not surprising in that the studies involved two gasifier types, and there is little commercial experience against which to benchmark costs. There is a variation (min to max) of 0.8 ¢/kW<sub>e</sub>-h for no capture and 0.9 ¢/kW<sub>e</sub>-h for CO<sub>2</sub> capture in the “as-reported” COE in the studies (Figure A-3.C.4, Appendix 3.C).

We used the same approach to estimate the COE for IGCC as for air-blown PC [54]. For IGCC w/o capture, the COE is about 0.4 cent/kW<sub>e</sub>-h higher than for supercritical PC generation, driven by somewhat higher capital and operating costs. The increase in COE for IGCC when CO<sub>2</sub> capture is added is about 1.4 ¢/kW<sub>e</sub>-h. This is about half the increase projected for amine capture with supercritical PC. The cost of avoided CO<sub>2</sub> is about \$ 20 per tonne which is about half that for air-blown PC technology. Oxy-fuel PC is in between air-blown PC with amine capture and IGCC with CO<sub>2</sub> capture, based on currently available data.

The COE values developed for this report compare well with the “normalized” values

**Figure 3.14 Parasitic Energy Requirement for IGCC with Pre-Combustion CO<sub>2</sub> Capture**

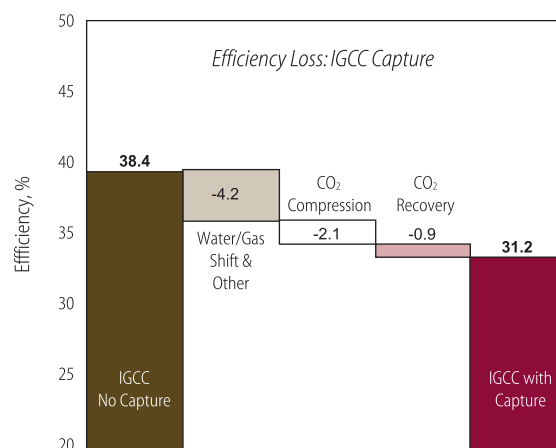

**Table 3.7 Relative Cost of Electricity from PC and IGCC Units, without and with CO<sub>2</sub> Capture\***

	MIT	GTC	AEP	GE
PC no-capture, reference	1.0	1.0	1.0	1.0
IGCC no-capture	1.05	1.11	1.08	1.06
IGCC capture	1.35	1.39	1.52	1.33
PC capture	1.60	1.69	1.84	1.58

*\*Included are: the MIT Coal Study results (MIT), the Gasification Technology Council (GTC) [56], General Electric (GE) [57], and American Electric Power (AEP) [58].*

from the design studies evaluated (Figure A-3.C.3 and A-3.C.4). Our values are close to the mean values for super-critical PC without and with capture. For IGCC, our values are at the high end of the range of the other design studies. Our COE for oxy-fuel PC is slightly higher than the “as-reported” values, although it is important to note that oxy-fuel data are based on only two published studies [44, 55].

To further validate the findings in this section, we compared our results with the COE estimates from several sources and summarize these results in Table 3.7. Supercritical PC without capture is set as the reference at 1.0. This suggests that without CO<sub>2</sub> capture, the cost of electricity from IGCC will be from 5 to 11% higher than from supercritical PC. When CO<sub>2</sub> capture is considered, the cost of electricity produced by IGCC would be increased by 30 to 50% over that of supercritical PC without capture, or 25 to 40% over that of IGCC without capture (Table 3.7). However, for supercritical PC with CO<sub>2</sub> capture, the cost of electricity is expected to increase by 60 to 85% over the cost for supercritical PC without capture. These numbers are for green-field plants; they are also for the Nth plant where N is less than 10; and they are based on cost estimates from the relatively stable 2000–2004 cost period.

**COAL TYPE AND QUALITY EFFECTS** Although gasification can handle almost any carbon-containing material, coal type and quality can have a larger effect on IGCC than on PC generation. IGCC units operate most effectively and efficiently on dry, high-carbon fuels such

as bituminous coals and coke. Sulfur content, which affects PC operation, has little effect on IGCC cost or efficiency, although it may impact the size of the sulfur clean-up process. For IGCC plants, coal ash consumes heat energy to melt it, requires more water per unit carbon in the slurry, increases the size of the ASU, and ultimately results in reduced overall efficiency. This is more problematic for slurry-feed gasifiers, and therefore, high-ash coals are more suited to dry-feed systems (Shell), fluid-bed gasifiers (BHEL), or moving-bed gasifiers (Lurgi)[25]. Slurry-fed gasifiers have similar problems with high-moisture coals and coal types with low heating values, such as lignite. These coal types decrease the energy density of the slurry, increase the oxygen demand, and decrease efficiency. Dry-feed gasifiers are favored for high-moisture content feeds.

Coal quality and heating value impact IGCC capital cost and generating efficiency more strongly than they affect these parameters for PC generation (see Figure A-3.A.3, Appendix 3.A) [25]. However, the lower cost of coals with low heating value can offset much of the impact of increased capital cost and reduced efficiency. To illustrate, the capital cost per kW<sub>e</sub> and the generating efficiency for an E-Gas IGCC plant designed for Texas lignite are estimated to be 37% higher and 24% lower respectively than if the unit were designed for Pittsburgh #8 coal [25]. For PC combustion the impact is significantly less: 24% higher and 10% lower respectively. As a result, we estimate that the COE for Texas lignite generation is about 20% higher (Figure A-3.A.4) than for Pittsburgh #8 coal because lower coal cost is not sufficient to offset the other increases.

Texas lignite has a high-moisture content and a low-carbon content, which is particularly bad for a slurry-feed gasifier. For a dry-feed gasifier, such as the Shell gasifier, the lignite would compare more favorably. Optimum gasifier type and configuration are influenced by coal type and quality, but there are limited data on these issues.

The available data illustrate several important trends and gaps. First, there is a lack of data and design studies for IGCC with low-heating value, low-quality coals and particularly for gasifiers other than water-slurry fed, entrained-flow systems. Second, PC generation without CO<sub>2</sub> capture is slightly favored over IGCC (lower COE) for high heating value, bituminous coals, but this gap increases as PC steam cycle efficiency increases and as coal heating value decreases. The COE gap is substantially widened (favoring PC) for coals with low heating values, such as lignite. Third, for CO<sub>2</sub> capture, the COE gap for high-heating value bituminous coals is reversed and is substantial (IGCC now being favored); but as coal heating value decreases, the COE gap is substantially narrowed. It appears that ultra-supercritical PC combustion and lower energy consuming CO<sub>2</sub> capture technology, when developed, could have a lower COE than water-slurry fed IGCC with CO<sub>2</sub> capture. This area needs additional study.

**U.S. CRITERIA POLLUTANT IMPACTS – ENVIRONMENTAL PERFORMANCE** IGCC has inherent advantages with respect to emissions control. The overall environmental footprint of IGCC is smaller than that of PC because of reduced volume and lower leachability of the fused slag, reduced water usage and the potential for significantly lower levels of criteria pollutant emissions. Criteria emissions control is easier because most clean-up occurs in the syngas which is contained at high pressure and has not been diluted by combustion air, i.e. nitrogen. Thus, removal can be more effective and economical than cleaning up large volumes of low-pressure flue gas.

The two operating IGCC units in the U.S. are meeting their permitted levels of emissions, which are similar to those of PC units. However, IGCC units that have been designed to do so can achieve almost order-of-magnitude lower criteria emissions levels than typical current U.S. permit levels and 95+% mercury removal with small cost increases. Appendix 3.D details the environmental performance demonstrated and expected.

Our point COE estimates suggest that although improvements in PC emissions control technology, including mercury control, will increase the COE from PC units, the levels of increased control needed to meet federal emissions levels for 2015 should not make the COE from a PC higher than that from an IGCC. We estimate that the increased emissions control to meet the U.S. 2015 regulations, including mercury, will increase the PC COE by about 0.22 ¢/kW<sub>e</sub>-h to 5.00 ¢/kW<sub>e</sub>-h and the COE for IGCC to 5.16 ¢/kW<sub>e</sub>-h (Appendix 3.D). This does not include the cost of emissions allowances or major, unanticipated regulatory or technological changes. Although the COE numbers for PC and IGCC are expected to approach one another, the cost of meeting criteria pollutant and mercury emissions regulations should not force a change in technology preference from PC to IGCC without CO<sub>2</sub> capture.

However, evaluation and comparison of generating technologies for future construction need to incorporate the effect of uncertainty in the key variables into the economic evaluation. This includes uncertainty in technology performance, including availability and ability to cycle, and cost, in regulatory changes, including timing and cost, and in energy costs and electricity demand/dispatch. Forward estimates for each variable are set, values, bounds and probabilities are established; and a Monte Carlo simulation is done producing a sensitivity analysis of how changes in the variables affect the economics for a given plant. This analysis shows that as permitted future pollutant emissions levels are reduced and the cost of emissions control increases, the NPV

cost gap between PC and IGCC will narrow; and at some point, increased emissions control can be expected to lead to IGCC having the lower NPV cost. This, of course, depends on when and the extent to which these changes occur and on how emissions control technology costs change with time and increasing reduction requirements. This type of analysis is used widely in evaluating the commercial economics of large capital projects, of which generation is a set, but is outside the scope of this report.

The same analysis applies to consideration of future CO<sub>2</sub> regulations. The introduction of a CO<sub>2</sub> tax at a future date (dependent on date of imposition, CO<sub>2</sub> tax rate, rate of increase, potential grandfathering and retrofit costs) will drive IGCC to be the lowest NPV cost alternative at some reasonable set of assumptions, and assuming today's technology performance. Substantial technology innovation could change the outcome, as could changing the feed from bituminous coal to lignite.

In light of all these considerations, it is clear that there is no technology today that is an obvious silver bullet.

**RETROFITS FOR CO<sub>2</sub> CAPTURE** Retrofitting an IGCC for CO<sub>2</sub> capture involves changes in the core of the gasification/combustion/power generation train that are different than the type of changes involved in retrofitting a PC plant for capture. The choice of the gasifier (slurry feed, dry feed), gasifier configuration (full-quench, radiant cooling, convective syngas coolers), acid gas clean-up, operating pressure, and gas turbine are dependent on whether a no-capture or a capture plant is being built. Appendix 3.E treats IGCC retrofitting in more detail.

No-capture designs tend to favor lower pressure [2.8 to 4.1 MPa (400–600 psi)] and increased heat recovery from the gasifier train (radiant coolers and even syngas coolers) to raise more steam for the steam turbine, resulting in a higher net generating efficiency. Dry feed (Shell) provides the highest efficiency and

is favored for coals with lower heating value, largely because of their higher moisture content; but the capital costs are higher. On the other hand, capture designs favor higher-pressure [6.0 MPa (1000 psi)] operation, slurry feed, and full-quench mode[59]. Full-quench mode is the most effective method of adding sufficient steam to the raw syngas for the water gas shift reaction without additional, expensive steam raising equipment and/or robbing steam from the steam cycle. Higher pressure reduces the cost of CO<sub>2</sub> capture and recovery, and of CO<sub>2</sub> compression. In addition, the design of a high-efficiency combustion turbine for high hydrogen concentration feeds is different from combustion turbines optimized for syngas, requires further development, and has very little operating experience. In summary, an optimum IGCC unit design for no CO<sub>2</sub> capture is quite different from an optimum unit design for CO<sub>2</sub> capture.

Although retrofitting an IGCC unit for capture would involve significant changes in most components of the unit if it is to result in an optimum CO<sub>2</sub>-capture unit, it appears that an IGCC unit could be successfully retrofit by addressing the key needed changes (adding shift reactors, an additional Selexol unit, and CO<sub>2</sub> compression/drying). In this case, retrofitting an IGCC unit would appear to be less expensive than retrofitting a PC unit, although it would not be an optimum CO<sub>2</sub>-capture unit. Pre-investment for later retrofit will generally be unattractive and will be unlikely for a technology that is trying to establish a competitive position. However, for IGCC, additional space could be set aside to facilitate future retrofit potential. In addition, planning for a possible retrofit for capture could influence initial design choices (e.g., radiant quench vs. full quench).

**IGCC OPERATIONAL HISTORY** In addition to cost, IGCC has to overcome the perception of poor availability and operability. Appendix 3.B provides more detail, beyond that discussed below. For each of the current IGCC demonstration plants, 3 to 5 years was required to reach 70 to 80% availability after

commercial operation was initiated. Because of the complexity of the IGCC process, no single process unit or component of the total system is responsible for the majority of the unplanned shutdowns that these units have experienced, reducing IGCC unit availability. However, the gasification complex or block has been the largest factor in reducing IGCC availability and operability. Even after reaching 70 to 80% availability, operational performance has not typically exceeded 80% consistently. A detailed analysis of the operating history of the Polk Power Station over the last few years suggests that it is very similar to operating a petroleum refinery, requiring continuous attention to avert, solve and prevent mechanical, equipment and process problems that periodically arise. In this sense, the operation of an IGCC unit is significantly different from the operation of a PC unit, and requires a different operational philosophy and strategy.

The Eastman Chemical Coal Gasification Plant uses a Texaco full-quench gasifier and a back-up gasifier (a spare) and has achieved less than 2% forced outage from the gasification/syngas system over almost 20 years operation. Sparring is one approach to achieving better on-line performance, and a vigorous equipment health maintenance and monitoring program is another. There are five operating in-refinery IGCC units based on petroleum residuals and/or coke; two are over 500 MW<sub>e</sub> each. Several other refinery-based gasification units produce steam, hydrogen, synthesis gas, and power. They have typically achieved better operating performance, more quickly than the coal-based IGCC units. Three more are under construction. It is fair to say that IGCC is well established commercially in the refinery setting. IGCC can also be considered commercial in the coal-based electricity generation setting, but in this setting it is neither well established nor mature. As such, it is likely to undergo significant change as it matures.

Our analysis assumes that IGCC plants, with or without capture, can “cycle” to follow load requirements. However, there is relatively little experience with cycling of IGCC plants

(although the 250 MW<sub>e</sub> Shell IGCC at Buggenum operated for 2 years in a load following mode under grid dispatch in the general range 50–100% load, and the Negishi IGCC unit routinely cycles between 100 to 75% load, both up and down, in 30 min) so considerable uncertainty exists for these performance features. Because an IGCC plant is “integrated” in its operation any shortfall in this performance could cause considerable increase in both variable and capital cost.

## COAL TO FUELS AND CHEMICALS

Rather than burning the syngas produced by coal gasification in a combustion turbine, it can be converted to synthetic fuels and chemicals. The syngas is first cleaned of particulates and sulfur compounds and undergoes water gas shift to obtain the desired hydrogen to CO ratio. Fischer-Tropsch technology can be used to convert this syngas or “synthesis gas” into predominantly high-quality diesel fuel, along with naphtha and LPG. Fischer-Tropsch technology involves the catalytic conversion of the hydrogen and carbon monoxide in the synthesis gas into fuel range hydrocarbons. This technology has been used in South Africa since the 1950’s, and 195,000 barrels per day of liquid fuels are currently being produced in that country by Fischer-Tropsch. Synthesis gas can also be converted to methanol which can be used directly or be upgraded into high-octane gasoline. For gaseous fuels production, the synthesis gas can be converted into methane, creating synthetic natural gas (SNG). Figure 3.15 illustrates three potential coal to fuels or chemicals process options. This type of process configuration could be called a coal refinery. More details are presented in Appendix 3.F.

Methanol production from coal-based synthesis gas is also a route into a broad range of chemicals. The naphtha and lighter hydrocarbons produced by Fischer-Tropsch are another route to produce a range of chemicals, in addition to the diesel fuel produced. The largest commodity chemical produced from

**Figure 3.15 Coal to Liquid Fuels, Synthetic Natural Gas and Chemicals**

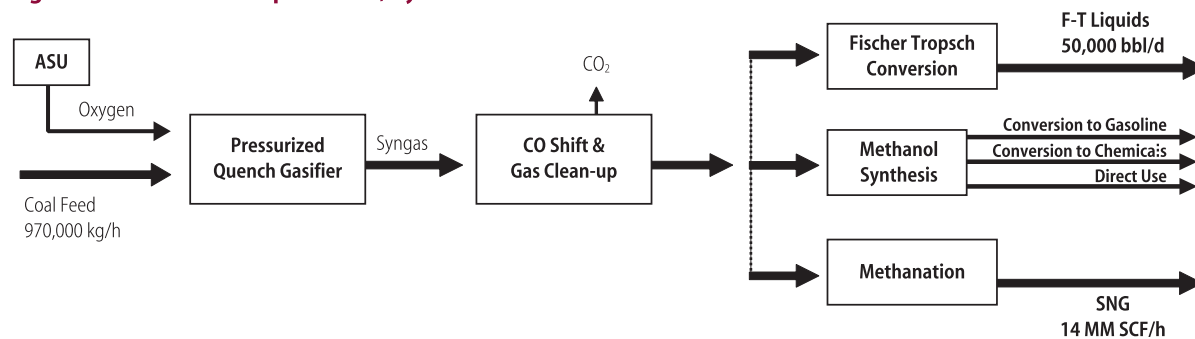

synthesis gas today is ammonia. Although most U.S. ammonia plants were designed to produce their syngas by reforming natural gas, world wide there are a significant number of ammonia plants that use syngas from coal gasification and more are under construction. These routes to chemicals are easily integrated into a coal refinery, as is power generation. Commercially, these processes will be applied to the extent that they make economic sense and are in the business portfolio of the operating company.

For such a coal refinery, all the carbon entering in the coal exits as carbon in the fuels or chemicals produced, or as CO<sub>2</sub> in concentrated gas form that could easily be compressed for sequestration. In this case, of order 50% to 70% of the carbon in the coal would be in the form of CO<sub>2</sub> ready for sequestration. If the gasification product were hydrogen, then essentially all the carbon entering the refinery in the coal would appear in concentrated CO<sub>2</sub> streams that could be purified and compressed for sequestration. Without carbon capture and sequestration (CCS), we estimate that the Fischer-Tropsch fuels route produces about 150% more CO<sub>2</sub> as compared with the use of the petroleum-derived fuel products. For SNG, up to 175% more CO<sub>2</sub> is emitted than if regular natural gas is burned. With CCS, the full fuel-cycle CO<sub>2</sub> emissions for both liquid fuel and SNG are comparable with traditional production and utilization methods. Fortunately, CCS does not require major changes to the process, large amounts of additional capital, or significant energy penalties because the CO<sub>2</sub> is a relatively pure byproduct of the pro-

cess at intermediate pressure. CCS requires drying and compressing to supercritical pressure. As a result of this the CO<sub>2</sub> avoided cost for CCS in conjunction with fuels and chemicals manufacture from coal is about one third of the CO<sub>2</sub> avoided cost for IGCC.

#### CITATIONS AND NOTES

1. NETL, *Power Plant Aging Characterization*. 2002.
2. NETL, *NETL Coal Power Database; Update for 2000 Operations, Technical and Performance Baseline*. 2002, NETL.
3. Average generating efficiency of the U.S. coal fleet was determined from the EIA Electric Power Annual Review (2003) by dividing the total MWe-h of coal-based electricity generated by the coal consumed in generating that power. This efficiency has been invariant from 1992 to 2003. NETL (2002) gives coal fleet plant efficiency as a function of plant age.
4. In the U.S., the generating technology choice depends upon a number of issues, including: cost, criteria pollutant limits, coal type, efficiency, plant availability requirements, plant location (elevation and temperature) and potential for carbon dioxide regulations.
5. Rubin, E., *Integrated Environmental Control Model 5.0*. 2005, Carnegie Mellon University: Pittsburgh.
6. Booras, G., and N. Holt, *Pulverized Coal and IGCC Plant Cost and Performance Estimates*, in *Gasification Technologies 2004*. 2004: Washington, DC.
7. Other modeling tools could have been used. Each would have given somewhat different results because of the myriad of design and parameter choices, and engineering approximations included in each. Model results are consistent with other models when operational differences are accounted for (Appendix 3-B).



8. U.S. engineering practice is to use the higher heating value (HHV) of the fuel in calculating generating efficiency, and electrical generating efficiencies are expressed on an HHV basis. Fuel prices are also normally quoted on an HHV basis. The HHV of a fuel includes the heat recovered in condensing the water formed in combustion to liquid water. If the water is not condensed, less heat is recovered; and the value is the Lower Heating Value (LHV) of the fuel.
9. Of these variables, steam cycle severity (steam temperature and pressure) is the most important. Steam cycle severity increases from subcritical to supercritical to ultrasupercritical. Increasing severity means that the steam carries more available energy to the steam turbine, resulting in higher generating efficiency.
10. Field, M.A., D. W. Gill, B.B. Morgan, P.G. W. Hawksley, *Combustion of Pulverized Coal*. 1967, Leatherhead, England: BCURA.
11. Smoot, L.D., & P. J. Smith, *Coal Combustion and Gasification*. The Plenum Chemical Engineering Series, ed. D. Luss. 1985, New York: Plenum Press.
12. Beer, J.M., *Combustion Technology Developments in Power Generation in Response to Environmental Challenges*. Elsevier Progress in Energy and Environmental Sciences, 2000. **26**: p. 301-327.
13. Parsons, E.L., W. W. Shelton, & J. L. Lyons, *Advanced Fossil Power Systems Comparison Study*. 2002a, NETL: Morgantown, WV.
14. Tonne is used to refer to metric or long tonnes, which are 2200 pounds or 1000 kg, and Ton is used to refer to a short ton which is 2000 pounds. Although both are used in this report, we are consistent in distinguishing tonne and ton.
15. Changes in operating parameters, excluding emissions control levels, can shift the generating efficiency by upwards to one percentage point. Large changes in emissions control levels can have a similarly large effect. A conservative set of parameters was used in this study, giving a generating efficiency somewhat below the midpoint of the range. See Appendix 3-B and Appendix 3-D for more detail.
16. As steam pressure and temperature are increased above 218 atm (3200 psi) and 375° C (706° F), respectively, the water-steam system becomes supercritical. Under these conditions the two-phase mixture of liquid water and gaseous steam disappears. Instead with increasing temperature the fluid phase undergoes gradual transition from a single dense liquid-like phase to a less dense vapor-like phase, characterized by its own unique set of physical properties.
17. However, due to materials-related boiler tube fatigue and creep stress in headers, steamlines, and in the turbines, the utility industry moved back to subcritical technology for new U. S. coal power plants. Even after the materials problems were resolved there was not a move back to supercritical PC because at the very cheap price of U. S. coal, the added plant cost could not be justified on coal feed rate savings.
18. Blum, R.a.J.H., *ELSAM Skaerbaek*. 2003: Denmark.
19. Weitzel, P.a.M.P., *Cited by Wiswqanathan, et al.* Power, 2004. **April**.
20. Scott, D.H., and P. A. Nilsson. *Competitiveness of Future Coal Fired Units in Different Countries*. in CCC/14. 1999. London, UK: IEA Coal Research.
21. Howard, J.R., *Fluidized Beds, Combustion, and Applications*. 1983, New York: Applied Science Publishers (Elsevier).
22. Beer, J.M. *The Fluidized Combustion of Coal*. in *XVth Symposium (Int'l) on Combustion*. 1976. MIT, Cambridge: The Combustion Institute, Pittsburgh.
23. Combustion-Engineering. *Fluid Bed Combustion Technology for Lignite*. 2005. CE Website.
24. PowerClean, T.N., *Fossil Fuel Power Generation State-of-the-Art*, P.T. Network, Editor. 2004, University of Ulster: Coleraine, UK. p. 9-10.
25. NCC, *Opportunities to Expedite the Construction of New Coal-Based Power Plants*. 2004, National Coal Council.
26. EPA. *Acid Rain Program Laws & Regulations, Title IV*. 2002 October 25, 2002 [cited November 2, 2005]; Available from: <http://www.epa.gov/airmarkets/arp/regs/index.html>.
27. EPRI. *Power Plants and Particulate Matter: Formation and Direct Emissions*. Environmental Issues 2005 February 2005 [cited September 18, 2005]; Available from: <http://www.epriweb.com/public/00000000001011505.pdf>.
28. EPA. *CAIR Caps*. 2005 [cited; Available from: [http://www.epa.gov/cair/charts\\_files/cair\\_emissions\\_costs.pdf](http://www.epa.gov/cair/charts_files/cair_emissions_costs.pdf)].
29. EPA, *Regulatory Impact Analysis of the Final Clean Air Mercury Rule*, U.S. EPA, Editor. 2005, EPA-452/R-05-003.
30. Oskarsson, K., Anders Berglund, Rolf Deling, Ulrika Snellman, Olle Stenback, and Jack Fritz, *A Planner's Guide for Selecting Clean-Coal Technologies for Power Plants*, in *World Bank Technical Paper No. 387*, W. Bank, Editor. 1997, World Bank: Washington.
31. EPA, *Control of Mercury Emissions from Coal Fired Electric Utility Boilers: An Update*. 2005, Air Pollution Prevention and Control, U.S. EPA: Research Triangle Park, NC.
32. The options for CO<sub>2</sub> capture include: (a) chemical absorption into solution, (b) physical adsorption with an adsorbent, (c) membrane separation from the gas, and (d) cryogenic separation, by distillation or freezing. Methods b through d are best suited to high concentrations of CO<sub>2</sub> and or gas streams at high pressure, and not the low concentrations of CO<sub>2</sub> in flue gas at one atmosphere total pressure.
33. Holt, N., *Advanced Coal Technologies for CO<sub>2</sub> Capture*, in *EPRI Global Climate Change Research Seminar*. 2005: Washington, DC.
34. Riemer, P.W.F., and W.G. Ormerod, *International Perspectives and the Results of Carbon Dioxide Capture, Disposal, and Utilization Studies*. Energy Conversion Management, 1995. **36**(6-9): p. 813-818.
35. These include EPRI reviews of electricity generating costs, National Coal Council consensus numbers, and generating equipment makers and utilities comments on published numbers.

36. Bozzuto, C.R., N. Nsakala, G. N. Liljedahl, M. Palkes, J.L. Marion, D. Vogel, J. C. Gupta, M. Fugate, and M. K. Guha, *Engineering Feasibility and Economics of CO<sub>2</sub> Capture on an Existing Coal-Fired Power Plant* [Report No. PPL-01-CT-09], NETL, U.S. Department of Energy, 2001, Alstom Power Inc.
37. Bohm, M.C., H. J. Herzog, J. E. Parsons, and R. C. Sekar, *Capture-Ready Coal Plants - Options, Technologies and Economics*. 2006.
38. Sekar, R.C., J. E. Parsons, H. J. Herzog, and H. D. Jacoby, *Future Carbon Regulations and Current Investments in Alternative Carbon-Fired Power Plant Designs*, in *MIT Global Climate Change Joint Program Publications*. 2005, MIT: Cambridge, MA. p. 19.
39. Dillon, D.J., R. S. Panesar, R. A. Wall, R. J. Allam, V. White, J. Gibbins, and M. R. Haines, *Oxy-combustion Processes for CO<sub>2</sub> Capture from Advanced Supercritical PF and NGCC Power Plant*, in *Greenhouse Gas Technologies Conference 7*. 2004: Vancouver, BC.
40. Jordal, K. and et. al, *Oxyfuel Combustion of Coal-Fired Power Generation with CO<sub>2</sub> Capture — Opportunities and Challenges*. XDO, 2004.
41. Andersson, K., H. Birkestad, P. Maksinen, F. Johnsson, L. Stromberg, and A. Lyngfelt, ed. *An 865 MW Lignite Fired CO<sub>2</sub> Free Power Plant- A Technical Feasibility Study*. Greenhouse Gas Control Technologies, ed. K. Gale. 2003, Elsevier Science Ltd.: New York.
42. Allam, R., *Oxyfuel Pathways*, in *MIT Carbon Sequestration Forum VII: Pathways to Lower Capture Costs*. 2006: Cambridge, Mass.
43. Reuters-News-Service. *Vattenfall Plans CO<sub>2</sub>-Free Power Plant in Germany*. 2005 [cited May 20, 2005]; Available from: [www.planetard.com](http://www.planetard.com).
44. Varagani, R.K., F. Chatel-Pelage, P. Pranda, M. Rostam-Abadi, Y. Lu, and A.C. Bose, *Performance Simulation and Cost Assessment of Oxy-Combustion Process for CO<sub>2</sub> Capture from Coal-Fired Power Plants*, in *Fourth Annual Conference on Carbon Sequestration*. 2005: Alexandria, VA.
45. Babcox\_&\_Wilcox, *Demonstration of the Oxy-Combustion Process for CO<sub>2</sub> Control at the City of Hamilton*, in *American Coal Council 2006 Mercury & Multi-Emissions Conference*. 2006.
46. NETL, *NETL Coal Power Database*, NETL, Editor. 2002, U.S. DOE.
47. Simbeck, D., *Existing Power Plants - CO<sub>2</sub> Mitigation Costs*, Personal communication to J.R. Katzer, 2005: Cambridge, MA.
48. Higman, C., and M. vanderBurgt, *Gasification*. 2003, New York: Elsevier.
49. Holt, N., *Integrated Gasification Combined Cycle Power Plants*, in *Encyclopedia of Physical Science and Technology*. 2001, Academic Press: New York.
50. Nuon Power Buggenum, The Netherlands, Shell gasifier (253 MWe, 1994): Wabash River IGCC, Terre Haute, IN, U.S. E-gas(262MW, 1995); Polk Power Station, Tampa, Florida, U.S., Texaco/GE gasifier(250 MW, 1996); Puertollana, Spain, Prenflo/Shell gasifier (298 MW, 1998)
51. Ono, T., *NPRC Negishi IGCC Startup and Operation*, in *Gasification Technologies 2003*. 2003: San Francisco, California.
52. Collodi, G., and R. M. Jones, *The Sarlux IGCC Project, an Outline of the Construction and Commissioning Activities*, in *1999 Gasification Technologies Conference*. 2003: San Francisco, California.
53. Holt, N., *IGCC Technology Status, Economics and Needs*, in *International Energy Agency Zero Emission Technologies Technology Workshop*. 2004a: Gold Coast, Queensland, Australia.
54. To estimate the COE for IGCC, without and with CO<sub>2</sub> capture, we developed a consistent set of TPC numbers from the design studies and then compared these and our cost deltas with industry consensus group numbers to arrive at the TPC numbers given in Table 3.5. We estimated the O&M costs and calculated the COE using the parameters in Table 3.4. These are the COE numbers in Table 3.5.
55. Parsons Infrastructure & Technology Group, Inc., *Updated Cost and Performance Estimates for Fossil Fuel Power Plants with CO<sub>2</sub> Removal*. 2002: Pittsburgh, PA & Palo Alto, Calif.
56. Childress, J., *Coal Gasification & IGCC/Polygen Performance & Prospects for the U.S.*, in *(2005) Platts IGCC Symposium*. 2005: Pittsburgh, PA.
57. Lowe, E., *GE's Gasification Development*, in *Gasification Technologies Council*. 2005: San Francisco, CA.
58. AEP, *American Electric Power, Ohio Public Utilities Commission Filing for Meigs IGCC Power Plant*, O. PUC, 2005.
59. Holt, N., *Gasification & IGCC - Status, Challenges, Design Issues & Opportunities*, in *Reaction Engineering International*. 2005: Salt Lake City, Utah.
60. Bechtel, *Gasification Plant Cost and Performance Optimization, Final Report*. 2003, Global Energy, Nexant: San Francisco.
61. Gray, D., and Glen Tomlinson, *Coproduction of Ultra Clean Transportation Fuels, Hydrogen, and Electric Power from Coal*. 2001, Mitretek.

# Chapter 4 — Geological Carbon Sequestration

Carbon sequestration is the long term isolation of carbon dioxide from the atmosphere through physical, chemical, biological, or engineered processes. The largest potential reservoirs for storing carbon are the deep oceans and geological reservoirs in the earth's upper crust. This chapter focuses on geological sequestration because it appears to be the most promising large-scale approach for the 2050 timeframe. It does not discuss ocean or terrestrial sequestration<sup>1,2</sup>.

In order to achieve substantial GHG reductions, geological storage needs to be deployed at a large scale.<sup>3,4</sup> For example, 1 Gt C/yr (3.6 Gt CO<sub>2</sub>/yr) abatement, requires carbon capture and storage (CCS) from 600 large pulverized coal plants (~1000 MW each) or 3600 injection projects at the scale of Statoil's Sleipner project.<sup>5</sup> At present, global carbon emissions from coal approximate 2.5 Gt C. However, given reasonable economic and demand growth projections in a business-as-usual context, global coal emissions could account for 9 Gt C (see table 2.7). These volumes highlight the need to develop rapidly an understanding of typical crustal response to such large projects, and the magnitude of the effort prompts certain concerns regarding implementation, efficiency, and risk of the enterprise.

The key questions of subsurface engineering and surface safety associated with carbon sequestration are:

## Subsurface issues:

- ❑ Is there enough capacity to store CO<sub>2</sub> where needed?
- ❑ Do we understand storage mechanisms well enough?
- ❑ Could we establish a process to certify injection sites with our current level of understanding?
- ❑ Once injected, can we monitor and verify the movement of subsurface CO<sub>2</sub>?

## Near surface issues:

- ❑ How might the siting of new coal plants be influenced by the distribution of storage sites?
- ❑ What is the probability of CO<sub>2</sub> escaping from injection sites? What are the attendant risks? Can we detect leakage if it occurs?
- ❑ Will surface leakage negate or reduce the benefits of CCS?

Importantly, there do not appear to be unresolvable open technical issues underlying these questions. Of equal importance, the hurdles to answering these technical questions well appear manageable and surmountable. As such, it appears that geological carbon sequestration is likely to be safe, effective, and competitive with many other options on an economic basis. This chapter explains the technical basis for these statements, and makes recommendations about ways of achieving early resolution of these broad concerns.

## SCIENTIFIC BASIS

A number of geological reservoirs appear to have the potential to store many 100's – 1000's of gigatons of CO<sub>2</sub>.<sup>6</sup> The most promising reservoirs are *porous and permeable rock bodies*, generally at depths, roughly 1 km, at pressures and temperatures where CO<sub>2</sub> would be in a supercritical phase.<sup>7</sup>

- *Saline formations* contain brine in their pore volumes, commonly of salinities greater than 10,000 ppm.
- *Depleted oil and gas fields* have some combination of water and hydrocarbons in their pore volumes. In some cases, economic gains can be achieved through enhanced oil recovery (EOR)<sup>8</sup> or enhanced gas recovery<sup>9</sup> and substantial CO<sub>2</sub>-EOR already occurs in the US with both natural and anthropogenic CO<sub>2</sub>.<sup>10</sup>
- *Deep coal seams*, often called unmineable coal seams, are composed of organic minerals with brines and gases in their pore and fracture volumes.
- Other potential geological target classes have been proposed and discussed (e.g., oil shales, flood basalts); however, these classes require substantial scientific inquiry and verification, and the storage mechanisms are less well tested and understood (see Appendix 4.A for a more detailed explanation).

Because of their large storage potential and broad distribution, it is likely that most geological sequestration will occur in saline formations. However, initial projects probably will occur in depleted oil and gas fields, accompanying EOR, due to the density and quality of subsurface data and the potential for economic return (e.g., Weyburn). Although there remains some economic potential for enhanced coal bed methane recovery, initial economic assessments do not appear promising, and substantial technical hurdles remain to obtaining those benefits.<sup>6</sup>

For the main reservoir classes, CO<sub>2</sub> storage mechanisms are reasonably well defined and

understood (Figure 4.1). To begin, CO<sub>2</sub> sequestration targets will have *physical barriers* to CO<sub>2</sub> migration out of the crust to the surface. These barriers will commonly take the form of impermeable layers (e.g., shales, evaporites) overlying the reservoir target, although they may also be dynamic in the form of regional hydrodynamic flow. This storage mechanism allows for very high CO<sub>2</sub> pore volumes, in excess of 80%, and act immediately to limit CO<sub>2</sub> flow. At the pore scale, *capillary forces* will immobilize a substantial fraction of a CO<sub>2</sub> bubble, commonly measured to be between 5 and 25% of the pore volume. That CO<sub>2</sub> will be trapped as a residual phase in the pores, and acts over longer time scales as a CO<sub>2</sub> plume which is attenuated by flow. Once in the pore, over a period of tens to hundreds of years, the CO<sub>2</sub> will *dissolve* into other pore fluids, including hydrocarbon species (oil and gas) or brines, where the CO<sub>2</sub> is fixed indefinitely, unless other processes intervene. Over longer time scales (hundreds to thousands of years) the dissolved CO<sub>2</sub> may react with minerals in the rock volume to *precipitate* the CO<sub>2</sub> as new carbonate minerals. Finally, in the case of organic mineral frameworks such as coals, the CO<sub>2</sub> will physically *adsorb* onto the rock surface, sometimes displacing other gases (e.g., methane, nitrogen).

Although substantial work remains to characterize and quantify these mechanisms, they are understood well enough today to trust estimates of the percentage of CO<sub>2</sub> stored over some period of time—the result of decades of studies in analogous hydrocarbon systems, natural gas storage operations, and CO<sub>2</sub>-EOR. Specifically, it is very likely that the fraction of stored CO<sub>2</sub> will be greater than 99% over 100 years, and likely that the fraction of stored CO<sub>2</sub> will exceed 99% for 1000 years<sup>6</sup>. Moreover, some mechanisms appear to be self-reinforcing.<sup>11,12</sup> Additional work will reduce the uncertainties associated with long-term efficacy and numerical estimates of storage volume capacity, but no knowledge gaps today appear to cast doubt on the fundamental likelihood of the feasibility of CCS.

**Figure 4.1 Schematic of Sequestration Trapping Mechanisms**

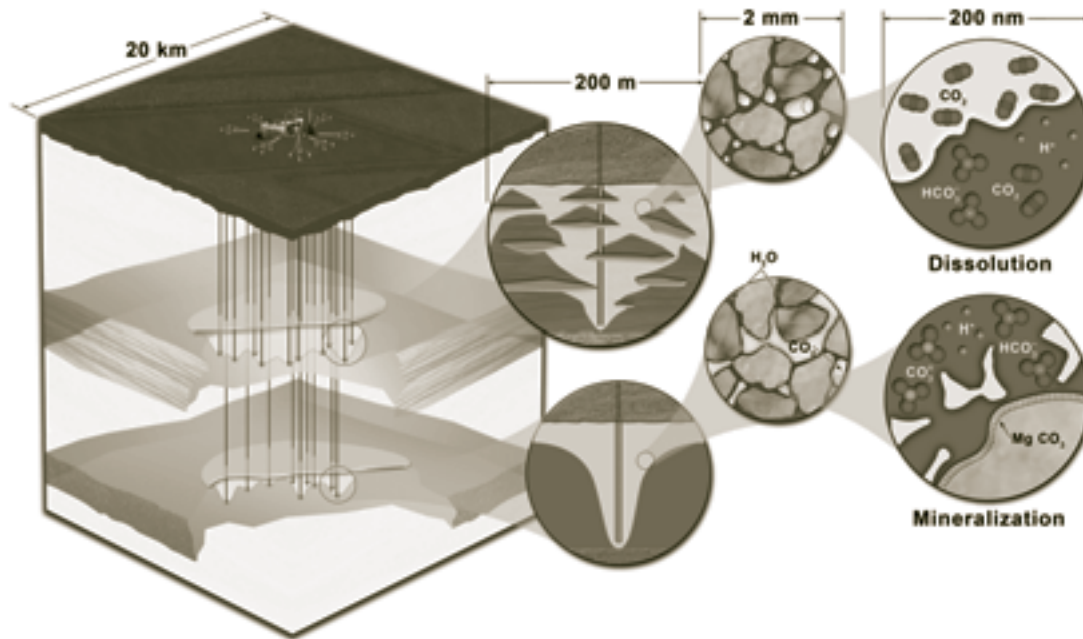

*Schematic diagram of large injection at 10 years time illustrating the main storage mechanisms. All CO<sub>2</sub> plumes are trapped beneath impermeable shales (not shown). The upper unit is heterogeneous with a low net percent usable, the lower unit is homogeneous. Central insets show CO<sub>2</sub> as a mobile phase (lower) and as a trapped residual phase (upper). Right insets show CO<sub>2</sub> dissolution (upper) and CO<sub>2</sub> mineralization (lower).*

## CAPACITY ESTIMATES

While improvement in understanding of storage mechanisms would help to improve capacity estimates, the fundamental limit to high quality storage estimates is uncertainty in the pore volumes themselves. Most efforts to quantify capacity either regionally or globally are based on vastly simplifying assumptions about the overall rock volume in a sedimentary basin or set of basins.<sup>13,14</sup> Such estimates, sometimes called “top-down” estimates, are inherently limited since they lack information about local injectivity, total pore volumes at a given depth, concentration of resource (e.g., stacked injection zones), risk elements, or economic characteristics.

A few notable exceptions to those kinds of estimates involve systematic consideration of individual formations and their pore structure within a single basin.<sup>15</sup> The most comprehensive of this kind of analysis, sometimes called “bottom-up”, was the GEODISC effort in

Australia.<sup>16</sup> This produced total rock volume estimates, risked volume estimates, pore-volume calculations linked to formations and basins, injectivity analyses, and economic qualifications on the likely injected volumes. This effort took over three years and \$10 million Aus. Institutions like the US Geological Survey or Geoscience Australia are well equipped to compile and integrate the data necessary for such a capacity determination, and would be able to execute such a task rapidly and well.

Our conclusions are similar to those drawn by the Carbon Sequestration Leadership Forum (CSLF), which established a task force to examine capacity issues.<sup>17</sup> They recognized nearly two-orders of magnitude in uncertainty within individual estimates and more than two orders magnitude variance between estimates (Figure 4.2). The majority of estimates support the contention that sufficient capacity exists to store many 100’s to many 1000’s of gigatons CO<sub>2</sub>, but this uncertain range is too large to inform sensible policy.

**Figure 4.2 Published Capacity Estimates**

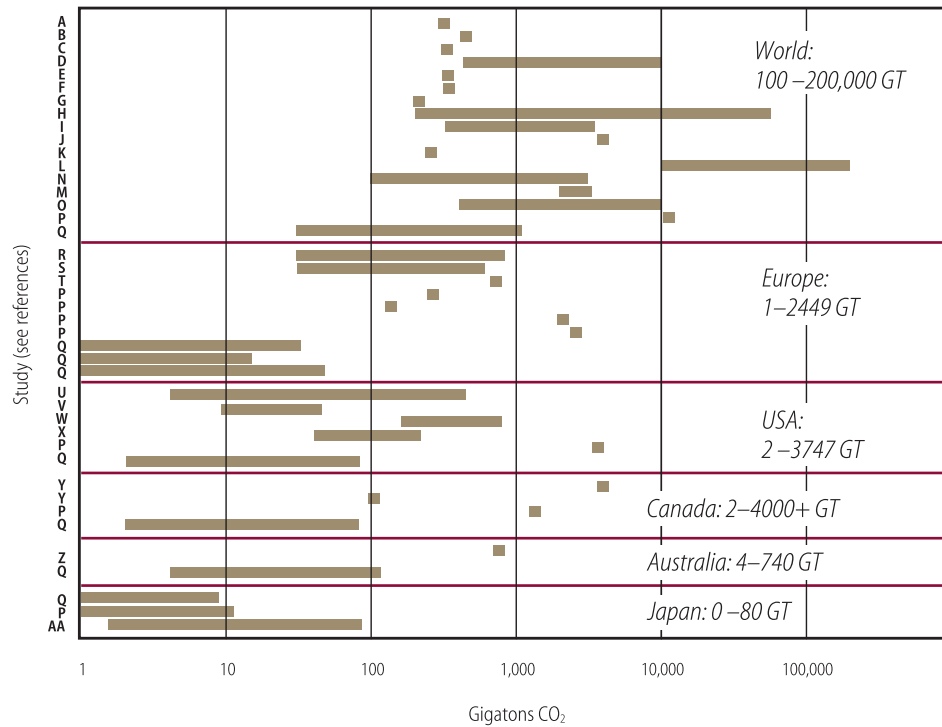

Graph showing published estimates of CO<sub>2</sub> capacity for the world, regions, and nations.<sup>17</sup> Note the large potential range of in some estimates (greater than 100x) and the unreasonably small uncertainties in other estimates (none provided). Note that some national estimates exceed some global estimates.

Accordingly, an early priority should be to undertake “bottom-up” capacity assessments for the US and other nations. Such an effort requires detailed information on individual rock formations, including unit thickness and extent, lithology, seal quality, net available percentage, depth to water table, porosity, and permeability. The geological character and context matters greatly and requires some expert opinion and adjudication. While the data handling issues are substantial, the costs would be likely to be low (\$10-50 million for a given continent; \$100 million for the world) and would be highly likely to provide direct benefits in terms of resource management.<sup>18</sup> Perhaps more importantly, they would reduce substantially the uncertainty around economic and policy decisions regarding the deployment of resource and crafting of regulation.

Within the US, there is an important institutional hurdle to these kinds of capacity estimates. The best organization to undertake this

effort would be the US Geological Survey, ideally in collaboration with industry, state geological surveys, and other organizations. This arrangement would be comparable in structure and scope to national oil and gas assessments, for which the USGS is currently tasked. This is analogous to performing a bottom-up CO<sub>2</sub> storage capacity estimation. However, the USGS has no mandate or resources to do CO<sub>2</sub> sequestration capacity assessments at this time.

The Department of Energy has begun assessment work through the seven Regional Carbon Sequestration Partnerships<sup>19</sup>. These partnerships include the member organizations of 40 states, including some state geological surveys. While the Partnerships have produced and will continue to produce some detailed formation characterizations, coverage is not uniform and the necessary geological information not always complete. As such, a high-level nationwide program dedicated to

bottom-up geological assessment would best serve the full range of stakeholders interested in site selection and management of sequestration, as do national oil and gas assessments.

## SITE SELECTION AND CERTIFICATION CRITERIA

Capacity estimates, in particular formation-specific, local capacity assessments, will underlie screening and site selection and help define selection criteria. It is likely that for each class of storage reservoir, new data will be required to demonstrate the injectivity, capacity, and effectiveness (ICE) of a given site.<sup>20</sup> A firm characterization of ICE is needed to address questions regarding project life cycle, ability to certify and later close a site, site leakage risks, and economic and liability concerns.<sup>21</sup>

Ideally, project site selection and certification for injection would involve detailed characterization given the geological variation in the shallow crust. In most cases, this will require new geological and geophysical data sets. The specifics will vary as a function of site, target class, and richness of local data. For example, a depleted oil field is likely to have well, core, production, and perhaps seismic data that could be used to characterize ICE rapidly. Still additional data (e.g., well-bore integrity analysis, capillary entry pressure data) may be required. In contrast, a saline formation project may have limited well data and lack core or seismic data altogether. Geological characterization of such a site may require new data to help constrain subsurface uncertainty. Finally, while injectivity may be readily tested for CO<sub>2</sub> storage in an unmineable coal seam, it may be extremely difficult to establish capacity and storage effectiveness based on local stratigraphy. Accordingly, the threshold for validation will vary from class to class and site to site, and the due diligence necessary to select a site and certify it could vary greatly.

**OPEN ISSUES** The specific concerns for each class of storage are quite different. For depleted hydrocarbon fields, the issues involve

incremental costs necessary to ensure well or field integrity. For saline formations, key issues will involve appropriate mapping of potential permeability fast-paths out of the reservoir, accurate rendering of subsurface heterogeneity and uncertainty, and appropriate geomechanical characterization. For unmineable coal seams, the issues are more substantial: demonstration of understanding of cleat structure and geochemical response, accurate rendering of sealing architecture and leakage risk, and understanding transmissivity between fracture and matrix pore networks. For these reasons, the regulatory framework will need to be tailored to classes of sites.

## MEASUREMENT, MONITORING, AND VERIFICATION: MMV

Once injection begins, a program for measurement, monitoring, and verification (MMV) of CO<sub>2</sub> distribution is required in order to:

- ▣ understand key features, effects, & processes needed for risk assessment
- ▣ manage the injection process
- ▣ delineate and identify leakage risk and surface escape
- ▣ provide early warnings of failure near the reservoir
- ▣ verify storage for accounting and crediting

For these reasons, MMV is a chief focus of many research efforts. The US Department of Energy has defined MMV technology development, testing, and deployment as a key element to their technology roadmap,<sup>19</sup> and one new EU program (CO<sub>2</sub> ReMoVe) has allocated €20 million for monitoring and verification. The IEA has established an MMV working group aimed at technology transfer between large projects and new technology developments. Because research and demonstration projects are attempting to establish the scientific basis for geological sequestration, they will require more involved MMV systems than future commercial projects.

Today there are three well-established large-scale injection projects with an ambitious scientific program that includes MMV: Sleipner (Norway)<sup>22</sup>, Weyburn (Canada)<sup>23</sup>, and In Salah (Algeria)<sup>24</sup>. Sleipner began injection of about 1Mt CO<sub>2</sub>/yr into the Utsira Formation in 1996. This was accompanied by time-lapse reflection seismic volume interpretation (often called 4D-seismic) and the SACS scientific effort. Weyburn is an enhanced oil recovery effort in South Saskatchewan that served as the basis for a four-year, \$24 million international research effort. Injection has continued since 2000 at about 0.85 Mt CO<sub>2</sub>/yr into the Midale reservoir. A new research effort has been announced as the Weyburn Final Phase, with an anticipated budget comparable to the first. The In Salah project takes about 1Mt CO<sub>2</sub>/yr stripped from the Kretchba natural gas field and injects it into the water leg of the field. None of these projects has detected CO<sub>2</sub> leakage of any kind, each appears to have ample injectivity and capacity for project success, operations have been transparent and the results largely open to the public. Over the next decade, several new projects at the MtCO<sub>2</sub>/yr scale may come online from the myriad of projects announced (see Table 4.1).

These will provide opportunities for further scientific study.

Perhaps surprisingly in the context of these and other research efforts, there has been little discussion of what are the most important parameters to measure and in what context (research/pilot vs. commercial). Rather, the literature has focused on the current ensemble of tools and their costs.<sup>25</sup> In part due to the success at Sleipner, 4-D seismic has emerged as the standard for comparison, with 4-D surveys deployed at Weyburn and likely to be deployed at In Salah. This technology excels at delineating the boundaries of a free-phase CO<sub>2</sub> plume, and can detect small saturations of conjoined free-phase bubbles that might be an indicator of leakage. Results from these 4D-seismic surveys are part of the grounds for belief in the long-term effectiveness of geological sequestration.

However, time-lapse seismic does not measure all the relevant parameters, and has limits in some geological settings. Key parameters for research and validation of CO<sub>2</sub> behavior and fate involve both direct detection of CO<sub>2</sub> and detection through proxy data sets (figure 4.3). Table 4.2 provides a set of key parameters, the current best apparent measurement and monitoring technology, other potential tools, and the status of deployment in the world's three largest injection demonstrations

Importantly, even in the fields where multiple monitoring techniques have been deployed (e.g., Weyburn), there has been little attempt to integrate the results (this was identified as a research gap from the Weyburn effort).<sup>23</sup> There are precious few formal methods to integrate and jointly invert multiple data streams. This is noteworthy; past analyses have demonstrated that formal integration of orthogonal data often provides robust and strong interpretations of subsurface conditions and characteristics.<sup>26,27</sup> The absence of integration of measurements represents a major gap in current MMV capabilities and understanding.

**Table 4.1 Proposed CCS Projects at the Mt/yr scale**

PROJECT	COUNTRY	PROJECT TYPE
Monash	Australia	Fuel
ZeroGen	Australia	Power
Gorgon	Australia	Gas Processing
SaskPower	Canada	Power
Greengem	China	Power
nZEC	China	Power
Vattenfall	Germany	Power
RWE	Germany	Power
Draugen	Norway	Power
Statoil Mongstad	Norway	Power
Snovit	Norway	Gas Processing
BP Peterhead	UK	Power
E.On	UK	Power
RWE npower	UK	Power (retrofit)
Progressive/Centrica	UK	Power
Powerfuel	UK	Power
FutureGen	USA	Power
BP Carson	USA	Power



**Figure 4.3 Hypothetical Site Monitoring Array**

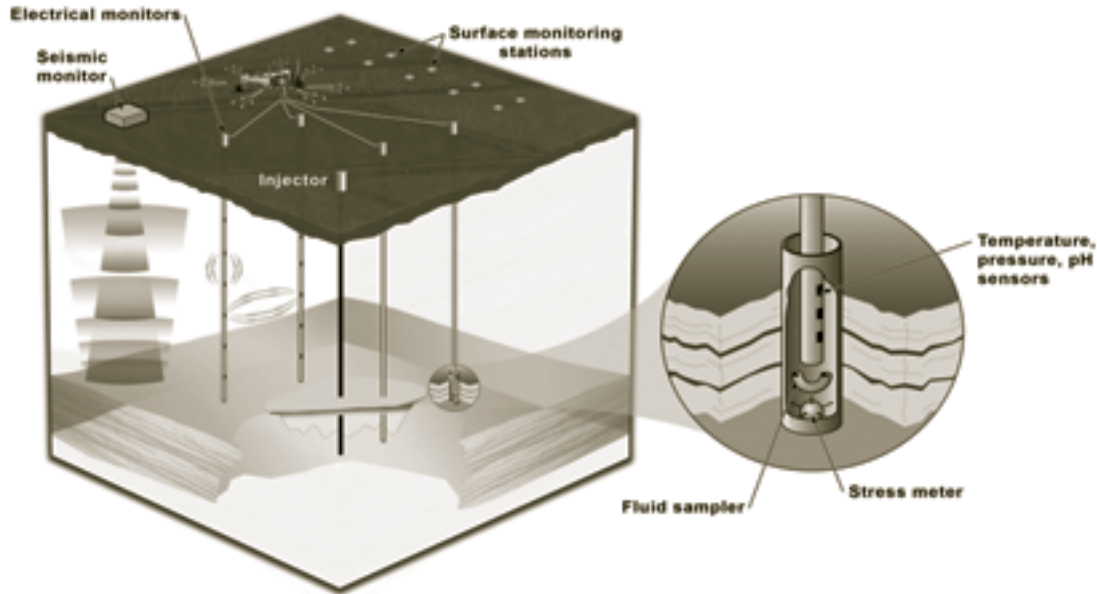

*Schematic diagram a monitoring array providing insight into all key parameters. Note both surface and subsurface surveys, and down-hole sampling and tool deployment. A commercial monitoring array would probably be much larger.*

In addition to development, testing, and integration of MMV technology, there is no standard accepted approach (e.g., best practices) to the operation of MMV networks. This is particularly important in future commercial projects, where a very small MMV suite focused on leak detection may suffice. To be effective, it is likely that MMV networks must cover the footprint of injection at a minimum, and include sampling near the reservoir and at the surface. Within the context of a large-scale deployment, it is likely that determination and execution of monitoring will involve a four-phase approach.

**1. Assessment and planning:** During this phase, the site is characterized geographically, geologically, geophysically, and geochemically. Forward simulation of monitoring approaches will help to predict the detection thresholds of a particular approach or tool. Based on this analysis, an array can be designed to meet the requirements of regulators and other stakeholders.

- 2. Baseline monitoring:** Before injection takes place, baseline surveys must be collected to understand the background and provide a basis for difference mapping.
- 3. Operational monitoring:** During injection, injection wells are monitored to look for circulation behind casing, failures within the well bore, and other operational problems or failures.
- 4. Array monitoring during and after injection:** This phase will involve active surface and subsurface arrays, with the potential for additional tools around high-risk zones. The recurrence and total duration of monitoring will be determined by the research goals, the site parameters, the commercial status and regulatory needs. Ideally, MMV data would be formally integrated to reduce operational cost and complexity and to provide higher fidelity.

The likely duration of monitoring is an important unresolved issue. It is impractical for monitoring to continue for hundreds of years after injection; a practical monitoring time

**Table 4.2 Key MMV Parameters and Environments, Methods, and Large-Scale Deployments**

PARAMETER	VIABLE TOOLS	WEYBURN	IN SALAH, <sup>†</sup>	SLEIPNER
Fluid composition	Direct sample at depth <sup>§</sup> (e.g., U-tube), surface sampling	some	??	no
T,P fieldwide	Thermocouples <sup>§</sup> , pressure transducers <sup>§</sup> , fiberoptic Bragg grating	no	??	no
Subsurface pH monitoring	Down hole pH sensors <sup>§</sup>	no	yes <sup>§</sup>	no
CO <sub>2</sub> distribution	Time-lapse seismic <sup>§</sup> , tilt, ERT, EMIT, microseismic	one <sup>§</sup>	one <sup>§</sup> or more	one <sup>§</sup>
CO <sub>2</sub> saturation	ERT <sup>§</sup> , EMIT <sup>§</sup> , advanced seismic methods	no	no	no
Stress changes	Tri-axial tensiometers <sup>§</sup> , fiberoptic Bragg grating	no	??	no
Surface detection	Eddy towers <sup>§</sup> , soil gas, FTIRS, LIDAR, PFC tracing <sup>§</sup> , noble gas tracing	one	??	one*

ERT = Electrical Resistivity Tomography,

EMIT = Electromagnetic Induction Tomography

<sup>§</sup> Indicates best in class monitoring technology

<sup>†</sup> In Salah is still in the process of finalizing their monitoring array.

\* The "surface" monitoring at Sleipner is different than other fields in that it is submarine rather than subaerial. Photo surveys and side-scan sonar surveys have not shown leakage

period should be defined either generally or at each site before injection begins. Substantial uncertainties remain regarding the detection thresholds of various tools, since the detection limit often involves assumptions about the distribution, continuity, and phase of subsurface CO<sub>2</sub>. Important issues remain about how to optimize or configure an array to be both effective and robust. This issue cannot be answered without testing and research at large-scale projects and without formal data integration.

### LEAKAGE RISKS

Since CO<sub>2</sub> is buoyant in most geological settings, it will seek the earth's surface. Therefore, despite the fact that the crust is generally well configured to store CO<sub>2</sub>, there is the possibility of leakage from storage sites.<sup>6</sup> Leakage of CO<sub>2</sub> would negate some of the benefits of sequestration.<sup>28</sup> If the leak is into a contained environment, CO<sub>2</sub> may accumulate in high enough concentrations to cause adverse health, safety, and environmental consequences.<sup>29,30,31</sup> For any subsurface injected fluid, there is also the concern for the safety of drinking water.<sup>32</sup> Based on analogous experience in CO<sub>2</sub> injection such as acid gas disposal and EOR, these risks appear small. However, the state of science today cannot provide quantitative estimates of their likelihood.

Importantly, CO<sub>2</sub> leakage risk is not uniform and it is believed that most CO<sub>2</sub> storage sites will work as planned.<sup>33</sup> However, a small percentage of sites might have significant leakage rates, which may require substantial mitigation efforts or even abandonment. It is important to note that the occurrence of such sites does not negate the value of the effective sites. However, a premium must be paid in the form of due diligence in assessment to quantify and circumscribe these risks well.

Wells almost certainly present the greatest risk to leakage,<sup>34</sup> because they are drilled to bring large volumes of fluid quickly to the earth's surface. In addition, they remove the aspects of the rock volume that prevent buoyant migration. Well casing and cements are susceptible to corrosion from carbonic acid. When wells are adequately plugged and completed, they trap CO<sub>2</sub> at depth effectively. However, there are large numbers of orphaned or abandoned wells that may not be adequately plugged, completed, or cemented (Chapter 4 Appendix B) and such wells represent potential leak points for CO<sub>2</sub>. Little is known about the specific probability of escape from a given well, the likelihood of such a well existing within a potential site, or the risk such a well presents in terms of potential leakage volume or consequence.<sup>35</sup> While analog situations provide some quantitative estimates (e.g., Crystal Geysers, UT)<sup>36</sup>, much remains to

be done to address these questions. Once a well is identified, it can be plugged or re-completed at fairly low cost.

There is the possibility of difficult to forecast events of greater potential damage. While these events are not analogous for CO<sub>2</sub> sequestration, events like the degassing of volcanic CO<sub>2</sub> from Lake Nyos<sup>37</sup> or the natural gas storage failure near Hutchinson, Kansas<sup>38</sup> speak to the difficulty of predicting unlikely events. However, while plausible, the likelihood of leaks from CO<sub>2</sub> sequestration causing such damage is exceedingly small (i.e., the rate of any leakage will be many orders of magnitude less than Lake Nyos and CO<sub>2</sub> is not explosive like natural gas).

Even though most potential leaks will have no impact on health, safety, or the local environment, any leak will negate some of the benefits of sequestration. However, absolute containment is not necessary for effective mitigation.<sup>28</sup> If the rate and volume of leakage are sufficiently low, the site will still meet its primary goal of sequestering CO<sub>2</sub> to reduce atmospheric warming and ocean acidification. The leak would need to be counted as an emissions source as discussed further under liability. Small leakage risks should not present a barrier to deployment or reason to postpone an accelerated field-based RD&D program.<sup>39</sup> This is particularly true of early projects, which will also provide substantial benefits of learning by doing and will provide insight into management and remediation of minor leaks.

A proper risk assessment would focus on several key elements, including both likelihood and potential impact. Efforts to quantify risks should focus on scenarios with the greatest potential economic or health and safety consequences. An aggressive risk assessment research program would help financiers, regulators, and policy makers decide how to account accurately for leakage risk.

## SCIENCE & TECHNOLOGY GAPS

A research program is needed to address the most important science and technology gaps related to storage. The program should address three key concerns: (1) tools to simulate the injection and fate of CO<sub>2</sub>; (2) approaches to predict and quantify the geomechanical response to injection; and (3) the ability to generate robust, empirically based probability-density functions to accurately quantify risks.

Currently, there are many codes, applications, and platforms to simulate CO<sub>2</sub> injection.<sup>40</sup> However, these codes have substantial limitations. First, they do not predict well the geomechanical response of injection, including fracture dilation, fault reactivation, cap-rock integrity, or reservoir dilation. Second, many codes that handle reactive transport, do not adequately predict the location of precipitation or dissolution, nor the effects on permeability. Third, the codes lack good modules to handle wells, specifically including the structure, reactivity, or geomechanical response of wells. Fourth, the codes do not predict the risk of induced seismicity. In order to simulate key coupled processes, future simulators will require sizeable computational resources to render large complex sedimentary networks, and run from the injection reservoir to the surface with high resolution in three dimensions. Given the capability of existing industry and research codes, it is possible to advance coupling and computation capabilities and apply them to the resolution of outstanding questions.

There is also a need to improve geomechanical predictive capability. This is an area where many analog data sets may not provide much insight; the concerns focus on rapid injection of large volumes into moderate-low permeability rock, and specific pressure and rate variations may separate reservoirs that fail mechanically from those that do not. This is particularly true for large-volume, high-rate injections that have a higher chance of exceeding important process thresholds. Fault response to stress, prediction of induced seis-

micity, fault transmissivity and hydrology, and fracture formation and propagation are notoriously difficult geophysical problems due to the complex geometries and non-linear responses of many relevant geological systems. Even with an improved understanding, the models that render fracture networks and predict their geomechanical response today are fairly simple, and it is not clear that they can accurately simulate crustal response to injection. A program that focuses on theoretical, empirical, laboratory, and numerical approaches is vital and should take advantage of existing programs within the DOE, DOD, and NSF.

The objective of these research efforts is to improve risk-assessment capabilities that results in the construction of reliable probability-density functions (PDFs). Since the number of CO<sub>2</sub> injection cases that are well studied (including field efforts) are exceedingly small, there is neither theoretical nor empirical basis to calculate CO<sub>2</sub>-risk PDFs. Accurate PDFs for formal risk assessment could inform decision makers and investors regarding the potential economic risks or operational liabilities of a particular sequestration project.

In terms of risk, leakage from wells remains the likeliest and largest potential risk.<sup>34,41,42</sup> The key technical, regulatory, and legal concerns surrounding well-bore leakage of CO<sub>2</sub> are discussed in Appendix 4.B.

## NEED FOR STUDIES AT SCALE

Ultimately, largescale injection facilities will be required to substantially reduce GHG emissions by CCS. Because the earth's crust is a complex, heterogeneous, non-linear system, field-based demonstrations are required to understand the likely range of crustal responses, including those that might allow CO<sub>2</sub> to escape from reservoirs. In the context of large-scale experiments, the three large volume projects currently operating do not address all relevant questions. Despite a substantial scientific effort, many parameters which would need to

be measured to circumscribe the most compelling scientific questions have not yet been collected (see Table 4.2), including distribution of CO<sub>2</sub> saturation, stress changes, and well-bore leakage detection. This gap could be addressed by expanded scientific programs at large-scale sites, in particular at new sites.

The projects sponsored by the DOE are mostly small pilot projects with total injection volume between 1000 and 10,000 metric tons. For example, the DOE sponsored a field injection in South Liberty, TX, commonly referred to as the Frio Brine Pilot.<sup>43,44</sup> The Pilot received ~1800 t of CO<sub>2</sub> in 2004, and is slated to receive a second injection volume of comparable size in 2006. The Regional Partnerships have proposed 25 geological storage pilots of comparable size, which will inject CO<sub>2</sub> into a wide array of representative formations.<sup>19</sup> These kinds of experiments provide value in validating some model predictions, gaining experience in monitoring, and building confidence in sequestration. However, pilots on this scale cannot be expected to address the central concerns regarding CO<sub>2</sub> storage because on this scale the injection transients are too small to reach key thresholds within the crust. As such, important non-linear responses that may depend on a certain pressure, pH, or volume displacement are not reached. However, they will be reached for large projects, and have been in each major test.

As an example, it has been known for many years that fluid injections into low-permeability systems can induce earthquakes small and large.<sup>45</sup> It is also known that while injection of fluids into permeable systems can induce earthquakes, even with large injection volumes the risk of large earthquakes is extremely low. The best example is a set of field tests conducted at Rangely oilfield in NW Colorado, where an aggressive water-injection program began in an attempt to initiate and control seismic events.<sup>46</sup> Despite large injections, the greatest moment magnitude measured as  $M_L$  3.1. Since that time, over 28 million tons of CO<sub>2</sub> have been injected into Rangely with limited seismicity, no large seismic events,

and no demonstrable leakage.<sup>47</sup> These studies make clear that injections of much smaller volumes would produce no seismicity. Thus to ascertain the risk associated with large injections requires large injection, as do the processes and effects of reservoir heterogeneity on plume distribution or the response of fractures to pressure transients.

### LARGE SCALE DEMONSTRATIONS AS CENTRAL SHORT-TERM OBJECTIVE

Ultimately, large-scale injections will require large volumes of CO<sub>2</sub> to ensure that injection transients approach or exceed key geological thresholds. The definition of large-scale depends on the site since local parameters vary greatly. In highly permeable, continuous rock bodies (e.g., Frio Fm. or Utsira Fm.), at least one million tons/yr may be required to reach these thresholds; in low permeability (e.g., Weber Sandstone or Rose Run Fm.) or highly segmented reservoirs, only a few 100,000 tons/year may be required. A large project would likely involve multiple wells and substantial geological complexity and reservoir heterogeneity (like In Salah and Weyburn). To observe these effects would likely require at least 5 years of injection with longer durations preferred.

Because of the financial incentives of additional production, CO<sub>2</sub>-EOR will continue to provide early opportunities to study large-scale injection (e.g., Weyburn). However, the overwhelming majority of storage capacity remains in saline formations, and there are many parts of the country and the world where EOR options are limited. Since saline formations will be central to substantial CO<sub>2</sub> emissions reduction, a technical program focused on understanding the key technical concerns of saline formations will be central to successful commercial deployment of CCS.

**Costs for the large projects are substantial.** For phase I, the Weyburn project spent \$27 million, but did not include the costs of CO<sub>2</sub> or well drilling in those costs. Because of cost

constraints, the Weyburn project did not include important monitoring and scientific studies. The cost of CO<sub>2</sub> supply could be low if one assumes that the CO<sub>2</sub> supply were already concentrated (e.g., a fertilizer or gas processing stream) and compression would be the largest operating cost. If CO<sub>2</sub> required market purchase (e.g., from KinderMorgan pipelines into the Permian Basin), then a price of \$20/ton CO<sub>2</sub> would represent a likely upper cost limit. Total cost would include compression costs, well count, reworking requirements, availability of key data sets, and monitoring complement. **Based on these types of consideration, an eight-year project could achieve key technical and operational goals and deliver important new knowledge for a total cost between \$100–225 million, corresponding to an annual cost roughly between \$13–28 million.** A full statement of the assumption set and calculation is presented in Appendix 4.C.

In sum, a large well-instrumented sequestration project at the necessary scale is required to yield the important information. However, only a small number of projects are likely to be required to deliver the needed insights for the most important set of geological injection conditions. For example, in the US only 3–4 sites might be needed to demonstrate and parameterize safe injection. These sites could include one project in the Gulf Coast, one in the central or northern Rocky Mountains, and one in either the Appalachian or Illinois basins (one could consider adding a fourth project in California, the Williston, or the Anadarko basins). This suite would cover an important range of population densities, geological and geophysical conditions, and industrial settings (Figure 4.4). More importantly, these 3–4 locations and their attendant plays are associated with large-scale current and planned coal-fired generation, making their parameterization, learning, and ultimate success important.

The value of information derived from these studies relative to their cost would be enormous. Using a middle cost estimate, all three

**Figure 4.4 Prospective Sites for Large-scale Sequestration Projects**

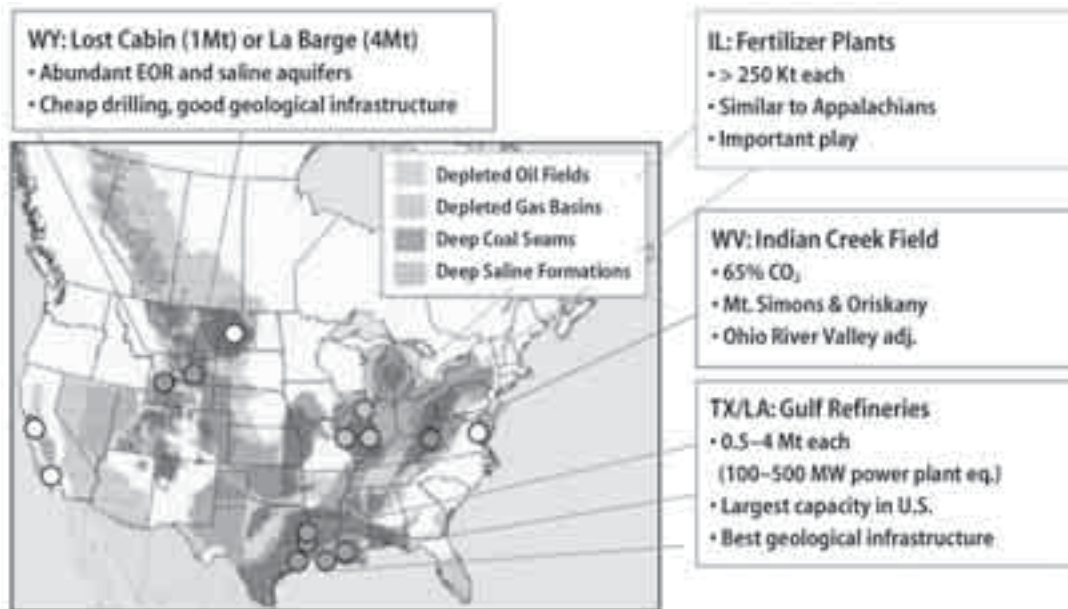

*Draft suggestions for 4 large UC storage projects using anthropogenic CO<sub>2</sub> sources. Basemap of sequestration targets from Dooley et al., 2004.*

basins could be studied for \$500 million over eight years. Five large tests could be planned and executed for less than \$1 billion, and address the chief concerns for roughly 70% of potential US capacity. Information from these projects would validate the commercial scalability of geological carbon storage and provide a basis for regulatory, legal, and financial decisions needed to ensure safe, reliable, economic sequestration.

The requirements for sequestration pilot studies elsewhere in the world are similar. The number of projects needed to cover the range of important geological conditions around the world to verify the storage capacity is of order 10. Using the screening and selection parameters described in Appendix 4.C, we believe that the world could be tested for approximately a few billion dollars. The case for OECD countries to help developing nations test their most important storage sites is strong; the mechanisms remain unresolved and are likely to vary case to case.

## DEVELOPING COUNTRIES

Developing nations, particularly China and India, will grow rapidly in the coming decades with an accompanying rapid growth in energy demand. Both countries have enormous coal reserves, and have plans to greatly increase national electrification with coal power. Projections for CO<sub>2</sub> emissions in both countries grow as a consequence, with the possibility that China will become the world's largest CO<sub>2</sub> emitter by 2030. Therefore it is important to know what sequestration options exist for both nations.

### China

The geological history of China is immensely complicated.<sup>48,49</sup> This history has produced 28 onshore sedimentary basins with roughly 10 large offshore basins (Figure 4.5). This presents a substantial task in geological assessment. However, many of these basins (e.g., Tarim, Junggar basins) are not near large CO<sub>2</sub> point sources or population centers and do not represent an assessment priority. Six on

**Figure 4.5 Prospective CO<sub>2</sub> Storage Basins in China**

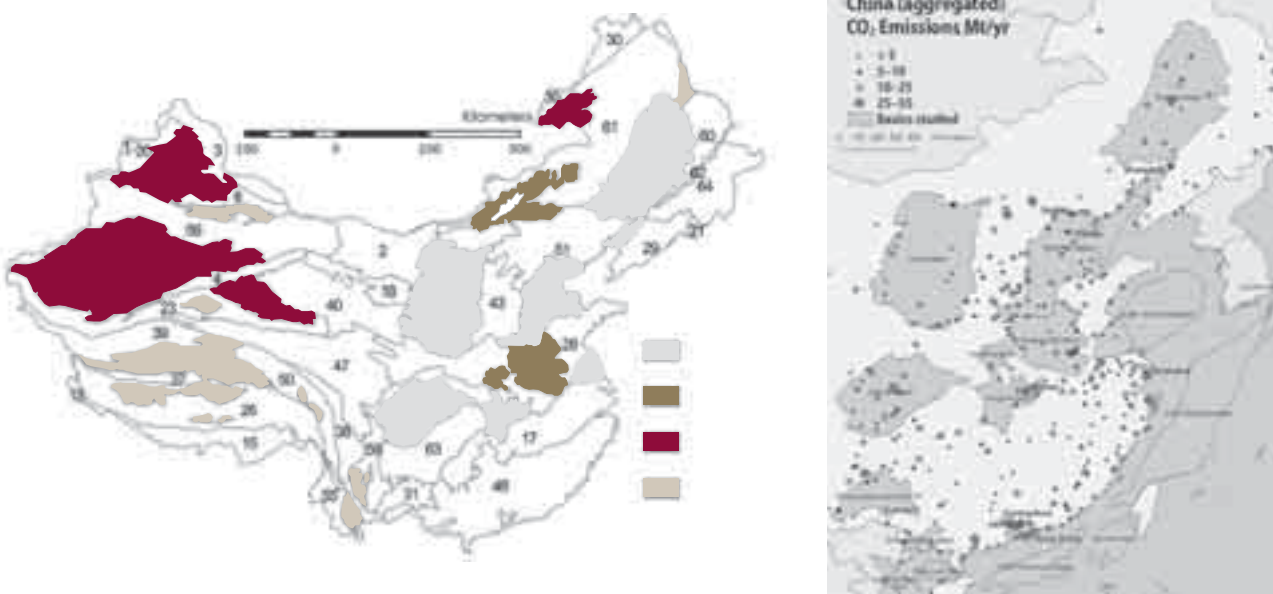

LEFT: Tectonic map of onshore China; all colored areas are sedimentary basins. Yellow represent high priority for assessments; green represent second tier; blue represent third tier; fourth tier are purple. Ranking is based on closeness to CO<sub>2</sub> point sources, presence of hydrocarbons, and complexity of geology. (Map courtesy of Stanford University.)  
 RIGHT: East China onshore and offshore basins with annual CO<sub>2</sub> emissions.<sup>52</sup>

shore and two offshore basins with relatively simple geological histories lie in the eastern half of China,<sup>50</sup> close to coal sources, industrial centers, and high population densities. These are also the basins containing the largest oil fields and gas fields in China.<sup>51</sup> Preliminary assessment suggests that these basins have prospectivity.<sup>52</sup> The initial estimates are based on injectivity targets of 100 mD, and continued assessment will change the prospectivity of these basins.

There are a number of active sequestration projects in China. RIPED, CNPC, and other industrial and government entities are pursuing programs in CO<sub>2</sub>-EOR. These are driven by economic and energy security concerns; continued study will reveal the potential for storage in these and other fields. Some western companies are also pursuing low-cost CO<sub>2</sub> projects; Shell is investigating a large CO<sub>2</sub> pilot, and Dow has announced plans to sequester CO<sub>2</sub> at one of its chemical plants. There is a 192 tonne Canadian-Chinese ECBM project in the Qinshui basin. However, there is much greater potential for very large CO<sub>2</sub> storage

tests using low-cost sources. China has many large coal gasification plants, largely for industrial purposes (e.g., fertilizer production, chemical plants). A number of these plants vent pure streams well in excess of 500,000 tons/y, and many are located within 150 km of viable geological storage and EOR targets.<sup>53</sup>

A program to determine the viability of large-scale sequestration in China would be first anchored in a detailed bottom-up assessment. The data for assessments exists in research institutions (e.g., RIPED, the Institute of for Geology and Geophysics) and the long history of geological study and infrastructure<sup>54,55</sup> suggests that Chinese teams could execute a successful assessment in a relatively short time, which could be followed by large injection tests. Given the central role of China's emissions and economy in the near future and the complexity of its geology, this should involve no less than two large projects. One might target a high-value, high chance of success opportunity (e.g., Bohainan basin; Songliao). Another might target lower permeability, more complicated targets (e.g., Sichuan or Ji-

anghan basin). In all cases, large projects do not need to wait for the development of IGCC plants, since there is already enormous gasification capacity and large pure CO<sub>2</sub> streams near viable targets. As with any large target, a ranking of prospects and detailed geological site characterization would be key to creating a high chance of project success.

## India

Geologically, India is a large granitic and metamorphic massif surrounded by sedimentary basins. These basins vary in age, complexity, and size. The largest sedimentary basin in the world (the Ganga basin) and one of the largest sedimentary accumulations (the Bengal fan) in India are close to many large point sources. In addition, a large basaltic massif (the Deccan Traps) both represents a potential CO<sub>2</sub> sink and also overlies a potential CO<sub>2</sub> sink (the underlying basins).

Currently, there is one CO<sub>2</sub> storage pilot planned to inject a small CO<sub>2</sub> volume into basalts. There are currently no plans for a detailed assessment or large-scale injection program. However, the IEA has announced a program to conduct an assessment. Many governmental groups have relevant data, including the Directorate General for Hydrocarbons, the Geological Survey of India, and the National Geophysical Research Institute. Several companies appear well equipped to undertake such work, including the Oil and Natural Gas Company of India. Despite the Indian government's involvement in the CSLF and FutureGen, it has not yet made the study of carbon sequestration opportunities a priority.

## CURRENT REGULATORY STATUS

**At present, there is no institutional framework to govern geological sequestration of CO<sub>2</sub> at large scale for a very long period of time.** At a minimum, the regulatory regime needs to cover the injection of CO<sub>2</sub>, account-

ing and crediting as part of a climate regime, and site closure and monitoring. In the United States, there does exist regulations for underground injections (see discussion below), but there is no category specific to CO<sub>2</sub> sequestration. A regulatory capacity must be built, whether from the existing EPA underground injection program or from somewhere else. *Building a regulatory framework for CCS should be considered a high priority item.* The lack of a framework makes it more difficult and costly to initiate large-scale projects and will result in delaying large-scale deployment

In the United States, there is a body of federal and state law that governs underground injection to protect underground sources of drinking water. Under authority from the Safe Drinking Water Act, EPA created the Underground Injection Control (UIC) Program, requiring all underground injections to be authorized by permit or rule and prohibiting certain types of injection that may present an imminent and substantial danger to public health. Five classes of injection wells have been set forth in the regulations, none specific to geological sequestration. A state is allowed to assume primary responsibility ("primacy") for the implementation and enforcement of its underground injection control program if the state program meets the requirements of EPA's UIC regulations. As shown in Figure 4.6, thirty-three states have full primacy over underground injection in their state, seven states share responsibility with EPA, and ten states have no primacy. A state program may go beyond the minimum EPA standards; in Nevada, for example, injection is not allowed into any underground aquifer regardless of salinity, which negates a potential sequestration option (Nevada Bureau of Mines and Geology, 2005).

The UIC achieves its primary objective of preventing movement of contaminants into potential sources of drinking water due to injection activities, by monitoring contaminant concentration in underground sources of drinking water. If traces of contaminants



**Figure 4.6 Current State and EPA Underground Injection Control Programs**

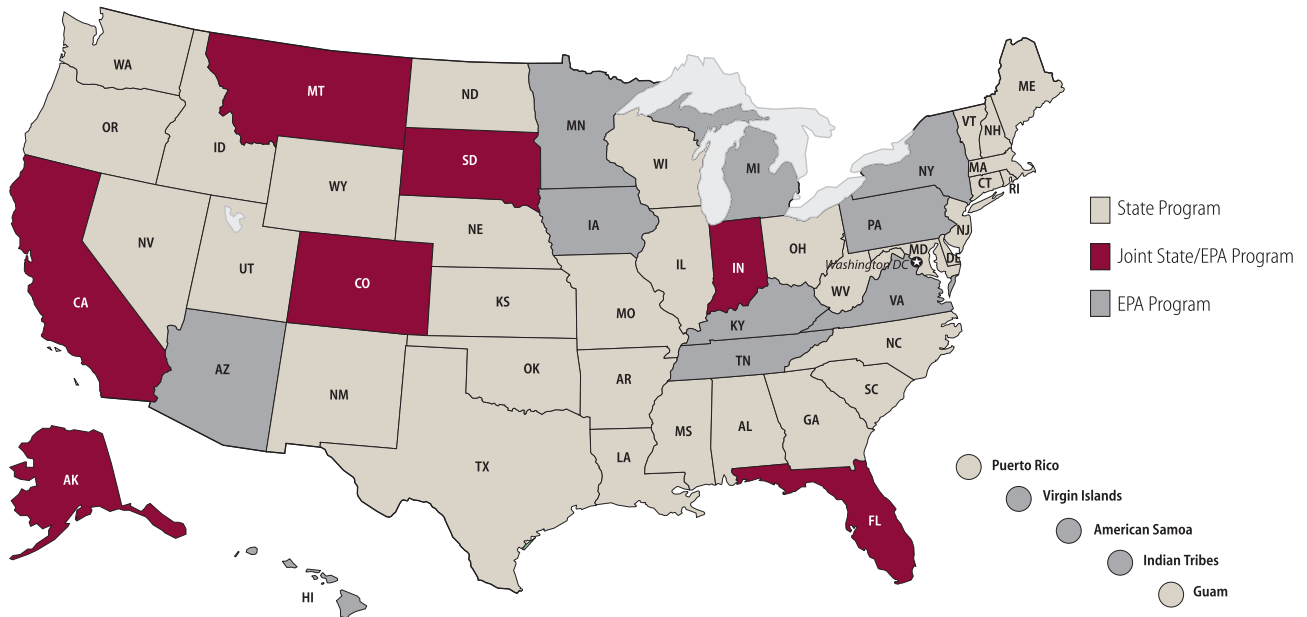

Source: EPA

are detected, the injection operation must be altered to prevent further pollution.

There are no federal requirements under the UIC Program to track the migration of injected fluids within the injection zone or to the surface.<sup>56</sup> Lack of fluid migration monitoring is problematic when the UIC regulatory regime is applied to geological sequestration. For example, one source of risk for carbon sequestration is that injected CO<sub>2</sub> potentially leaks to the surface through old oil and gas wells. For various reasons, such as existing infrastructure and proved cap rock, the first geological sequestration projects in the US will likely take place at depleted oil and gas fields. These sites possess numerous wells, some of which can act as high permeability conduits to the surface. Plugs in these wells may be lacking, poor, or subject to corrosion from CO<sub>2</sub> dissolved in brine. The presence of wells at sequestration sites greatly increases the chance for escape of injected gas. Regulations will be needed for the particular circumstance of CO<sub>2</sub> storage. This will involve either modification of the UIC regulations or creation of a new framework.

Unlike onshore geological sequestration, which is governed by national law, offshore geological sequestration is governed by international law. Offshore sequestration has not been specifically addressed in any multilateral environmental agreements that are currently in force, but may fall under the jurisdiction of international and regional marine agreements, such as the 1972 London Convention, the 1996 Protocol to the London Convention, and the 1992 OSPAR Convention. Because these agreements were not designed with geological sequestration in mind, they may require interpretation, clarification, or amendment by their members. Most legal scholars agree that there are methods of offshore sequestration currently compatible with international law, including using a land-based pipeline transporting CO<sub>2</sub> to the sub-seabed injection point and injecting CO<sub>2</sub> in conjunction with offshore hydrocarbon activities.<sup>57</sup>

### LIABILITY

Liability of CO<sub>2</sub> capture and geological sequestration can be classified into **operational liability** and **post-injection liability**.

**Operational liability**, which includes the environmental, health, and safety risks associated with carbon dioxide capture, transport, and injection, can be managed within the framework that has been successfully used for decades by the oil and gas industries.

**Post-injection liability**, or the liability related to sequestered carbon dioxide after it has been injected into a geologic formation, presents unique challenges due to the expected scale and timeframe for sequestration. The most likely sources of post-injection liability are groundwater contamination due to subsurface migration of carbon dioxide, emissions of carbon dioxide from the storage reservoir to the atmosphere (i.e., non-performance), risks to human health, damage to the environment, and contamination of mineral reserves. Our understanding of these risks needs to be improved in order to better assess the liability exposure of operators engaging in sequestration activities.

In addition, a regulatory and liability framework needs to be adopted for the closing of geological sequestration injection sites. The first component of this framework is monitoring and verification. Sequestration operations should be conducted in conjunction with modeling tools for the post-injection flow of carbon dioxide. If monitoring validates the model, a limited monitoring and verification period (5-10 years) after injection operations may be all that is required, with additional monitoring and verification for exceptional cases. The second component of the framework defines the roles and financial responsibilities of industry and government after abandonment. A combination of a funded insurance mechanism with government back-stop for very long-term or catastrophic liability will be required. Financial mechanisms need to be considered to cover this responsibility. There are a number of ways in which the framework could proceed. For example, in the case of nuclear power, the Price-Anderson Act requires that nuclear power plant licensees purchase the maximum amount of commercial liability insurance available on the private market

and participate in a joint-insurance pool. Licensees are not financially responsible for the cost of any accident exceeding these two layers of insurance. Another example would be the creation of a fund with mandatory contributions by injection operators. We suggest that industry take financial responsibility for liability in the near-term, i.e. through injection phase and perhaps 10-20 years into the post-injection phase. Once certain validation criteria are met, government would then assume financial responsibility, funded by industry insurance mechanisms, and perhaps funded by set-asides of carbon credits equal to a percentage of the amount of CO<sub>2</sub> stored in the geological formation.

## SEQUESTRATION COSTS

Figure 4.7 shows a map of US coal plants overlaid with potential sequestration reservoirs. The majority of coal-fired power plants are situated in regions where there are high expectations of having CO<sub>2</sub> sequestration sites nearby. In these cases, the cost of transport and injection of CO<sub>2</sub> should be less than 20% of total cost for capture, compression, transport, and injection.

Transportation for commercial projects will be via pipeline, with cost being a function of the distance and quantity transported. As shown in Figure 4.8, transport costs are highly non-linear for the amount transported, with economies of scale being realized at about 10 Mt CO<sub>2</sub>/yr. While Figure 4.8 shows typical values, costs can be highly variable from project to project due to both physical (e.g., terrain pipeline must traverse) and political considerations. For a 1 GW<sub>e</sub> coal-fired power plant, a pipeline must carry about 6.2 Gt CO<sub>2</sub>/yr (see footnote 1). This would result in a pipe diameter of about 16 inches and a transport cost of about \$1/tCO<sub>2</sub>/100 km. Transport costs can be lowered through the development of pipeline networks as opposed to dedicated pipes between a given source and sink.

**Figure 4.7 Location of Coal Plants Relative to Potential Storage Sites**

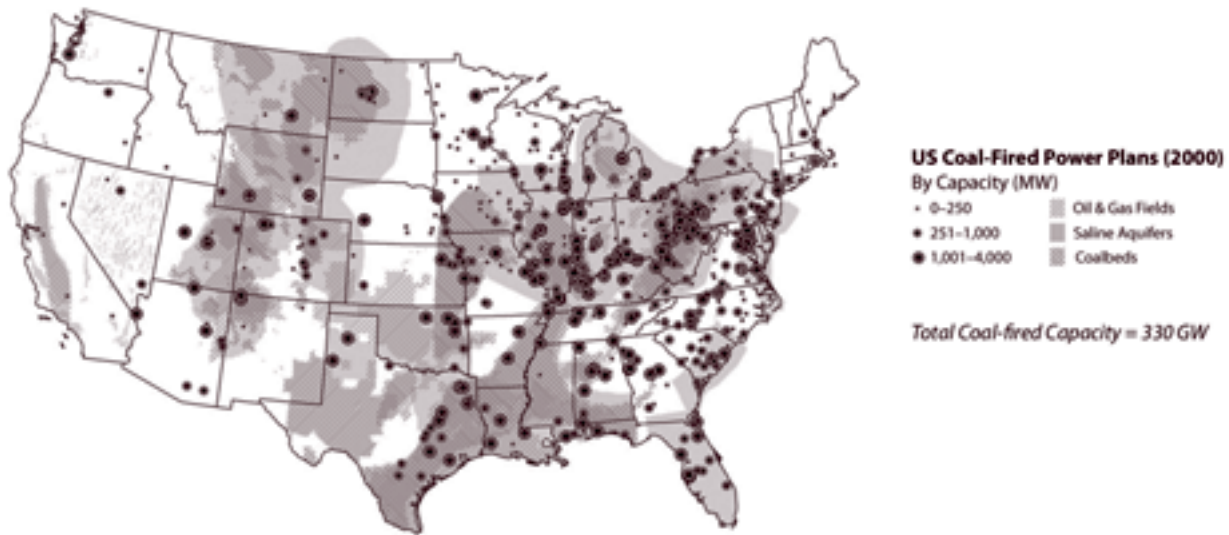

Map comparing location of existing coal-fired power plants in the US with potential sequestration sites. As stated earlier in the report, our knowledge of capacity for sequestration sites is very limited. Some shaded areas above may prove inappropriate, while detailed surveys may show sequestration potential in places that are currently not identified.

Costs for injecting the CO<sub>2</sub> into geologic formations will vary on the formation type and its properties. For example, costs increase as reservoir depth increases and reservoir injectivity decreases (lower injectivity results in the drilling of more wells for a given rate of CO<sub>2</sub> injection). A range of injection costs has been reported as \$0.5-8/tCO<sub>2</sub>.<sup>6</sup> Costs will also vary with the distance transported, the capacity utilization of the pipe, the transport pressure and the costs of compression (which also produces CO<sub>2</sub>).

It is anticipated that the first CCS projects will involve plants that are very close to a sequestration site or an existing CO<sub>2</sub> pipeline. As the number of projects grow, regional pipeline networks will evolve. This is similar to the growth of existing regional CO<sub>2</sub> pipeline networks in west Texas and in Wyoming to deliver CO<sub>2</sub> to the oil fields for EOR. For example, Figure 4.7 suggests that a regional pipeline network may develop around the Ohio River valley, transporting much larger volumes of CO<sub>2</sub>.

## RECOMMENDATIONS

Our overall judgment is that the prospect for geological CO<sub>2</sub> sequestration is excellent. We base this judgment on 30 years of injection experience and the ability of the earth's crust to trap CO<sub>2</sub>. That said, there remain substantial open issues about large-scale deployment of carbon sequestration. Our recommendations aim to address the largest and most important of these issues. Our recommendations call for action by the U.S. government; however, many of these recommendations are appropriate for OECD and developing nations who anticipate the use CCS.

**Figure 4.8 Cost for CO<sub>2</sub> Transport Via Pipeline as a Function of CO<sub>2</sub> Mass Flow Rate**

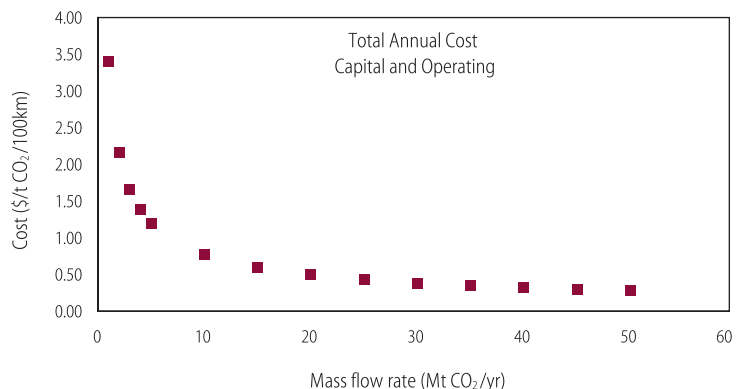

1. The US Geological Survey and the DOE, and should embark of a 3 year “bottom-up” analysis of US geological storage capacity assessments. This effort might be modeled after the GEODISC effort in Australia.
2. The DOE should launch a program to develop and deploy large-scale sequestration demonstration projects. The program should consist of a minimum of three projects that would represent the range of US geology and industrial emissions with the following characteristics:
  - Injection of the order of 1 million tons CO<sub>2</sub>/year for a minimum of 5 years.
  - Intensive site characterization with forward simulation, and baseline monitoring
  - Monitoring MMV arrays to measure the full complement of relevant parameters. The data from this monitoring should be fully integrated and analyzed.
3. The DOE should accelerate its research program for CCS S&T. The program should begin by developing simulation platforms capable of rendering coupled models for hydrodynamic, geological, geochemical, and geomechanical processes. The geomechanical response to CO<sub>2</sub> injection and determination or risk probability-density functions should also be addressed.
4. A regulatory capacity covering the injection of CO<sub>2</sub>, accounting and crediting as part of a climate regime, and site closure and monitoring needs to be built. Two possible paths should be considered — evolution from the existing EPA UIC program or a separate program that covers all the regulatory aspects of CO<sub>2</sub> sequestration.
5. The government needs to assume liability for the sequestered CO<sub>2</sub> once injection operations cease and the site is closed. The transfer of liability would be contingent on the site meeting a set of regulatory criteria (see recommendation 4 above) and the operators paying into an insurance pool to cover potential damages from any future CO<sub>2</sub> leakage.

## CITATIONS AND NOTES

1. From a technical perspective, ocean sequestration appears to be promising due to the ocean’s capacity for storage (IPCC 2005). Presently, because of concerns about environmental impacts, ocean sequestration has become politically unacceptable in the US and Europe.
2. Terrestrial storage, including storage in soils and terrestrial biomass, remains attractive on the basis of ease of action and ancillary environmental benefits. However, substantial uncertainties remain regarding total capacity, accounting methodology, unforeseen feedbacks and forcing functions, and permanence.
3. Pacala, S., and Socolow, R., *Stabilization Wedges: Solving the Climate Problem for the Next 50 Years Using Current Technologies*, *Science*, 2004, v.305, pp. 986
4. US Dept. of Energy, *Climate Change Technology Program Strategic Plan*, 2005, Washington, 256 p. <http://www.climatechange.gov/>
5. A 1000 MW bituminous pulverized coal plant with 85% capacity factor and 90% efficient capture would produce a CO<sub>2</sub> stream mass of 6.24 million t/yr. If injected at 2 km depth with a standard geothermal gradient, the volume rate of supercritical CO<sub>2</sub> would be 100,000 barrels/day (for comparison, the greatest injection rate for any well in the world is 40,000 bbl/d, and typical rates in the US are <3000 bbl/d). This suggests that initially either multiple long-reach horizontal wells or tens of vertical wells would be required to handle the initial volume. Over 50 years, the lifetime typical of a large coal plant, this would be close to 2 billion barrels equivalent, or a giant field for each 1000 MW plant.
6. Intergovernmental Panel on Climate Change, *IPCC Special Report on Carbon Dioxide Capture and Storage*, 2005, Interlachen, <http://www.ipcc.ch/>
7. Bachu S., *Sequestration of Carbon Dioxide in Geological Media: Criteria and Approach for Site Selection*, *Energy Conversion and Management*, 2000, v.4, pp. 970
8. Stevens, S. 1999. *Sequestration of CO<sub>2</sub> in Depleted Oil and Gas Fields: Barriers to Overcome in Implementation of CO<sub>2</sub> Capture and Storage (Disused Oil and Gas Fields)* IEA Greenhouse Gas R&D Programme, IEA/CON/98/31.
9. Oldenburg, C.M., S.H. Stevens, and S.M. Benson, Economic feasibility of carbon sequestration with enhanced gas recovery (CSEGR), *Energy*, 29,1413–1422, 2004 LBNL-49762
10. Jarrell, PM, CE Fox, MH Stein, SL Webb, *Practical Aspects of CO<sub>2</sub> flooding*. Monograph 22. Society of Petroleum Engineers, Richardson, TX, USA., 2002
11. Johnson, J.W., Nitao, J.J., Knauss, K.G., *Reactive transport modeling of CO<sub>2</sub> storage in saline aquifers to elucidate fundamental processes, trapping mechanisms, and sequestration partitioning*, in R. Gieré & P. Stille (eds.), *Energy, Waste, and the Environment - A Geochemical Perspective*. Geological Society of London, Special Publication, 2004
12. Johnson, J.W., Nitao, J.J., Morris, J.P., *Reactive transport modeling of cap rock integrity during natural and engineered CO<sub>2</sub> storage*, in S. Benson (ed.), *CO<sub>2</sub> Capture Project Summary Volume (2)*, Elsevier, 2005

13. Bergman, PD, and Winter, EM, Disposal of carbon dioxide in aquifers in the US, *Energy Conversion & Management*, 1995, v.36, pp. 523.
14. Dooley, JJ, and Friedmann, S.J., A regionally disaggregated global accounting of CO<sub>2</sub> storage capacity: data and assumptions, Pacific Northwest National Laboratory, Report PNWD-3431, 2004
15. Gibson-Poole CM, Lang SC, Streit JE, Kraishan GM, Hillis RR, Assessing a basin's potential for geological sequestration of carbon dioxide: an example from the Mesozoic of the Petrel Sub-basin, NW Australia; Keep, M. & Moss, S.J. (eds). *The Sedimentary Basins of Western Australia 3: Proceedings of the Petroleum Exploration Society of Australia Symposium*, Perth, 2002, pp. 439
16. Bradshaw J, Allison G, Bradshaw BE, Nguyen V, Rigg AJ, Spencer L, Wilson, P., Australia's CO<sub>2</sub> Geological storage potential and matching of emission sources to potential sinks. In: *Greenhouse gas control technologies: Proceedings of the 6th International Conference on Greenhouse Gas Control Technologies*, 1–4 October 2002, Kyoto, 2003
17. Carbon Sequestration Leadership Forum, Discussion Paper on Capacity Estimation, Technical Working Group, Olveida, Spain, 2005. <http://www.cslforum.org/presentations.htm>
18. Friedmann, S.J., Dooley, J.J., Held, H., Edenhofer, O., The low cost of geological assessment for underground CO<sub>2</sub> storage: Policy and economic implications, *Energy Conversion Management*, in press
19. US Dept. of Energy, Carbon Sequestration Technology Roadmap and Program Plan for 2006, Morgantown, WV, 2006, 39p.
20. *Injectivity* is the rate at which CO<sub>2</sub> injection may be sustained over fairly long intervals of time (months to years); *Capacity* is the total volume of potential CO<sub>2</sub> storage CO<sub>2</sub> at a site or in a formation; *Effectiveness* is the ability of the formation to store the injected CO<sub>2</sub> well beyond the lifetime of the project.
21. Friedmann SJ, The ICE framework for CO<sub>2</sub> storage site characterization, NETL 5th Annual Conference on Carbon Sequestration, Alexandria, VA, ExchangeMonitor Publications, 2006
22. Arts, R., O. Eiken, A. Chadwick, P. Zweigel, L. van der Meer, B. Zinsner, Monitoring of CO<sub>2</sub> injected at Sleipner using time-lapse seismic data, 2004, *Energy*, v.29, pp. 1383
23. Wilson M, Monea M. (Eds.), IEA GHG Weyburn CO<sub>2</sub> Monitoring & Storage Project Summary Report 2000-2004, 2004, 273 p.
24. Riddiford, F, Wright, I, Espie, T, and Torqui, A, 2004, Monitoring geological storage: In Salah Gas CO<sub>2</sub> Storage Project, GHGT-7, Vancouver
25. Benson SM, M Hoversten, E Gasperikova, M Haines, 2004, Monitoring Protocols and life-Cycle costs for Geological Storage of carbon Dioxide, GHGT-7, Vancouver
26. Hoversten, G. M., Gritto, G., R.; Daily, T.; Washbourne, J., 2002, Fluid saturation and pressure prediction in a multicomponent reservoir by combined seismic and electromagnetic imaging SEG Expanded Abstracts 1770-1773
27. Ramirez, A, and 8 others, 2005, Stochastic inversion of electrical resistivity changes using a Markov Chain Monte Carlo approach, *Journal of Geophysical Research*, v. 110, B02101
28. Herzog, H., K. Caldeira and J. Reilly, "An Issue of Permanence: Assessing the Effectiveness of Temporary Carbon Storage," *Climatic Change*, Vol. 59, No. 3, pp 293-310, August (2003).
29. Snodgrass, WR, Physiological and biochemical differences between children and adults as 5 determinants of toxic exposure to environmental pollutants. In *Similarities and differences between children and adults: Implications for risk assessment*. Guzelain, P.S., C.J. Henry, S.S. Olin (eds.), ILSI Press, Washington, DC, USA., 1992
30. National Institute for Occupational Safety and Health (NIOSH): Pocket Guide to Chemical Hazards. DHHS publication no. 97-140. US Government Printing Office, Washington, 25 DC, USA, 1997
31. Rice, SA. Human health risk assessment of CO<sub>2</sub>: survivors of acute high-level exposure and 40 populations sensitive to prolonged low level exposure. Poster 11-01 presented at 3rd Annual conference on carbon sequestration, 3-6 May 2004, Alexandria, VA, USA.
32. Knauss, KG, JW Johnson, YK Kharaka, Preliminary Reactive Transport Modeling and Laboratory Experiments Conducted in Support of the Frio Pilot Test, NETL 4th Annual Conference on Carbon Sequestration, 2005, Alexandria VA, ExchangeMonitor
33. Bradshaw, J, Boreham, C, and la Pedalina, F., 2004, Storage retention time of CO<sub>2</sub> in sedimentary basins; examples from petroleum systems, GHGT-7, Vancouver
34. Gasda, S.E., S. Bachu, and M.A. Celia, "The Potential for CO<sub>2</sub> Leakage from Storage Sites in Geological Media: Analysis of Well Distribution in Mature Sedimentary Basins", *Environmental Geology*, 46 (6-7), 707-720, 2004.
35. Scherer, G.W., M.A. Celia, J.H. Prevost, S. Bachu, R. Brulant, A. Duguid, R. Fuller, S.E. Gasda, M. Radonjic, and W. Vichit-Vadakan, "Leakage of CO<sub>2</sub> through Abandoned Wells: Role of Corrosion of Cement", in *The CO<sub>2</sub> Capture and Storage Project (CCP), Volume II*, D.C. Thomas and S.M. Benson (Eds.), 823-844, 2005
36. Gouveia, F.J., M. Johnson, R.N. Leif, S.J. Friedmann, 2005: Aerometric measurement and modeling of the mass of CO<sub>2</sub> emissions from Crystal Geyser, Utah; NETL 4th Annual CO<sub>2</sub> sequestration conference, Alexandria
37. Kling, MA Clark, HR Compton, JD Devine, WC Evans, AM Humphrey, EJ Doenigsberg, P Lockword, ML Tuttle and GW Wagner.: The lake gas disaster in Cameroon, West Africa, *Science*, 1987, v.236, 4798, pp. 169-175
38. Lee, AM, 2001: The Hutchinson Gas Explosions: Unraveling a Geologic Mystery, Kansas Bar Association, 26th Annual KBA/KIOGA Oil and Gas Law Conference, v1, p3-1 to 3-29.
39. Dooley JJ, Dahowski RT, Davidson CL, Wise MA, Gupta N, Kim SH, Malone EL, 2006, Carbon dioxide capture and geologic storage: A core technology element of a global technology strategy to address climate change, GTSP Technology Report, [www.battelle.org/gtsp](http://www.battelle.org/gtsp)

40. Pruess, K, J Garcia, T Kavscek, C Oldenburg, J Rutqvist, C Steefel, T Xu, Code intercomparison builds confidence in numerical simulation models for geologic disposal of CO<sub>2</sub>, *Energy*, 2004, v29, pp 1431–1444.
41. Ide, ST., SJ Friedmann, HJ Herzog, 2006, CO<sub>2</sub> Leakage through Existing Wells: Current Technology and Regulations, 8th International Conference on Greenhouse Gas Control Technologies, Trondheim, Norway.
42. Gale, J. (2004), "Geological storage of CO<sub>2</sub>: What do we know, where are the gaps and what more needs to be done?" *Energy* 29, 1329-1338
43. Hovorka SD, Collins D, Benson S, Myer L, Byrer C, Cohen K, Update on the Frio Brine Pilot: Eight months after injection, 4th Annual Conference on Carbon Capture and Sequestration, Alexandria, Virginia May 2–5, 2005
44. Shinichi Sakurai, T. S. Ramakrishnan, Austin Boyd, Nadja Mueller, Tom Daley, Mike Hoversten, John Peterson, Integrated Evaluation for Measuring, Monitoring, and Verifying CO<sub>2</sub> Distribution, 4th Annual Conference on Carbon Capture and Sequestration, Alexandria, Virginia May 2–5, 2005
45. Healy, JH, Griggs DT, Rubey WW, Coakley JM, 1968, *Science*, v. 161, 1301
46. Raleigh, C, JH Healy, JD Bredehoeft, 1976, An experiment in earthquake control at Rangely, Colorado, *Science*, v. 191, 1230-1237
47. Klusman, R.W. 2003b. Rate measurements and detection of gas microseepage to the atmosphere from an enhanced oil recovery/sequestration project, Rangely, Colorado, USA. *App. Geochem.*, 18, 1825-1838
48. Carroll, AR, Graham, SA, Hendrix, MS, Ying, D, Zhou, D, 1995, Late Paleozoic tectonic amalgamation of northwestern China; sedimentary record of the northern Tarim, northwestern Turpan, and southern Junggar basins, *GSA Bulletin*; May 1995; v. 107; no. 5; p. 571-594
49. Gilder, S. and 9 others, 1996, isotopic and paleomagnetic constraints on the Mesozoic tectonic evolution of south China, *Journal of Geophysical Research*, Volume 101, Issue B7, p. 16137-16154
50. Quanmao, C., and Dickinson, W., 1986, Contrasting nature of petroliferous Mesozoic/Cenozoic basins in Eastern and Western China, *AAPG bulletin*, v70, p 263-275
51. Desheng, L, 1984, Geological evolution of petroliferous basins on continental shelf of China, *AAPG Bulletin*, v68, p 993-1003
52. Newlands, I.K., Langford, R., 2005. CO<sub>2</sub> Storage Prospectivity of Selected Sedimentary Basins in the Region of China and South East Asia, *Geoscience Australia, Record 2005/13*. 223 p
53. Meng K, Celia M, Williams RH, 2005, Opportunities for Low-Cost Carbon Capture and Storage Demonstration Projects in China, , 4th Annual Conference on Carbon Capture and Sequestration, Alexandria, Virginia May 2–5, 2005
54. Zhai G. 1997, *Petroleum Geology of China*, 680 p.
55. Zhang W, Yan D., 1993, *Petroleum Geology of China-Bohai Gulf Basin*, v.1 of 20, 157p.
56. Wilson E, Johnson T, and Keith D, 2003: Regulating the ultimate sink: managing the risks of geologic CO<sub>2</sub> storage, *Envtl. Sci. Tech.* 37: 3476-3483.
57. International Energy Agency, *Legal Aspects of Storing CO<sub>2</sub>* (2005).

# Chapter 5 — Coal Consumption in China and India

## INTRODUCTION

China is expected to account for more than half of global growth in coal supply and demand over the next 25 years. The implications for the global environment are both complex and substantial. This chapter explores the circumstances under which China might constrain its carbon emissions from coal significantly below the currently forecast range. India, with a population comparable to that of China, a rapidly growing economy, and large domestic coal reserves, may one day come to rival China as a source of carbon emissions from coal. Like China, India derives over half of its commercial energy from coal, and together the two countries are projected to account for over 68% of the incremental demand in world coal through 2030.<sup>1</sup> Today, however, India consumes only about a fifth as much coal as its neighbor, and for the foreseeable future the consumption gap between the two countries will remain wide. The main focus of this chapter is thus on China, but in the final section we briefly compare patterns of coal use in the two countries.

Coal is today China's most important and abundant fuel, accounting for about two thirds of the country's primary energy supply. Coal output in China rose from 1.30 billion tonnes in 2000 to 2.23 billion tonnes in 2005,<sup>2</sup> making China by far the world's largest coal producer (the next largest, the United States, produced 1.13 billion tonnes last year). All but a few percent of this coal is consumed domestically, and China's coal use amounts to nearly a third of all coal consumed worldwide (see Figure 1). Electricity generation accounts for

just over half of all coal utilization in China, having risen from 22% of total consumption in 1988 to over 53% in 2002.<sup>3</sup> Coal currently accounts for about 80% of China's electricity generation, more than 50% of industrial fuel utilization, and about 60% of chemical feedstocks. Forty-five percent of China's national railway capacity is devoted to the transport of coal.<sup>4</sup> The central government has announced its intention to reduce the country's reliance on coal, but for the foreseeable future it will remain China's dominant fuel, and will very likely still account for more than half of the country's primary energy supplies in the year 2030. The largest contributor to future growth in China's demand for coal will be the electric power sector.

The recent growth of the Chinese power sector has been dramatic. Electricity generation grew at a rate of 15.2% in 2003, 14.8% in 2004, 12.3% in 2005, and 11.8% (on an annual basis) in the first quarter of 2006.<sup>5</sup> Total generating capacity increased by nearly a third in the last three years and is expected to double between 2002 and 2007. In 2005, about 70,000 MWe of new generating capacity was brought into service. A similar completion of new plants is projected for each of the next two years.<sup>6</sup> At this rate, China is adding the equivalent of nearly the entire UK power grid each year. Most of the existing and new generating capacity is fueled with coal, and China's coal-fired power plants are the main cause of the rapid increase in its greenhouse gas emissions, which are already the world's second largest after the United States.

**Figure 5.1 World Coal Consumption, 2004**

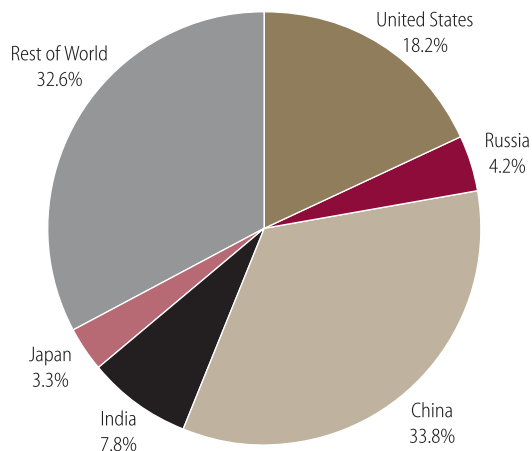

Source: Energy Information Administration, *International Energy Page* (Table Posted July 12, 2006)

Chinese energy statistics—including those pertaining to coal consumption and power generation—suffer serious problems of reliability. Data reported by both official and unofficial sources exhibit substantial variation and numerous inconsistencies. Indeed, different figures for annual coal consumption are noted in this chapter and in Chapter Two. But there is no dispute about the general trend exhibited by the data: Chinese energy consumption is trending rapidly upward.

The supercharged recent growth rates in the power sector may moderate in coming years, but the general trend of strong growth is likely to continue for a long time to come. Electricity consumption per capita in China, at about 1,700 kilowatt hours per year, is still only 20% of the average per capita consumption in the world's advanced economies. Rapid economic development is changing the lifestyles and energy needs of hundreds of millions of Chinese citizens. Future demand growth on a large scale seems assured.

A full understanding of China's current energy situation—including the types of fuels being consumed, the kinds of technologies employed, the effectiveness of environmental regulation, and the international reach of its enterprises—starts with three key characteristics of the Chinese system.

□ *First, especially at the national level, China's energy-related governmental bureaucracy is highly fragmented and poorly coordinated.* Responsibility for energy pricing, for the approval of infrastructure projects, for the oversight of state energy companies, and for long-term energy policy is spread across many agencies, most of them seriously understaffed, and some of which—given their very recent emergence on the scene—are notably weak in relation both to other agencies and to the players they are supposed to be regulating.

□ *Second, under these conditions the state energy companies—the national oil corporations and the national power generating groups—are the most coherent entities.* These are the organizations that are most capable of defining their own interests and that are most likely to act, making decisions that their ostensible state regulators and overseers can barely keep up with and sometimes do not even monitor. At the same time, and reflecting China's increasingly deep integration with the global economy, these corporate entities are hardly simple organizations themselves. Listed on both domestic and foreign stock exchanges, the state energy corporations encompass complicated groupings of stakeholders, including state-appointed senior executives, domestic and foreign corporate board members, major financiers from the global investment banking community, and international institutional investors. Textbook examples of shareholder-driven corporate governance they are not, but neither are they simple puppets of the state—in no small part because the state itself is so fragmented and lacks a clear voice on energy policy. In essence, the central government in Beijing today has neither a coherent national energy strategy nor much capacity to monitor, support, or impede the actions of state-owned energy companies—actions that are often misunderstood by outsiders as merely echoing government policy.



□ *Third, and most important, the remarkably rapid growth of energy consumption in China has been possible because a host of infrastructural issues are being resolved very quickly by individuals and organizations operating well below the level of national energy corporations.* Almost daily, actors at the grass roots level are making key decisions about China's physical and technological infrastructure—decisions with profound consequences for its long-term energy development.

Thus, it is a mistake to attribute China's aggregate energy demand growth—or even the actions of the state-owned energy companies—to central government agendas or geopolitical strategy. What many outsiders see as the deliberate result of Chinese national 'energy strategy' is in fact better understood as an agglomeration of *ad hoc* decisions by local governments, local power producers, and local industrial concerns. These local actors are primarily motivated by the need to maintain a high rate of economic growth and few, if any, have the national interest in mind. They are rushing to fill a void left by the absence of a coherent national-level energy strategy. Amidst surging energy demand and frenetic local decision-making, agencies and individuals in the central government are scrambling simply to keep abreast of developments on the ground. China's astonishingly rapid energy development may well be spinning the heads of outsiders, but it is vexing, perplexing, and even overwhelming to Chinese governmental insiders too.

## METHODOLOGY

The main conclusions of this chapter are based upon fieldwork conducted in China by a team based at the MIT Industrial Performance Center beginning in 2002, but concentrated primarily in 2005. Our goal was to study decision-making in the Chinese power and coal industry sectors. The study primarily employed a case-based approach, supplemented by extensive interviews at various levels of Chinese gov-

ernmental, academic, and commercial circles. The cases center primarily on the electric power sector and they were selected to represent three general modes of energy-related problem solving in the Chinese system: (1) relatively standard coal-fired power generation by municipal-level plants; (2) "within the fence" self-generation (co-generation) by industrial users or other commercial entities operating outside of what is generally understood as the energy sector; and (3) more future-oriented regional efforts by China's wealthiest coastal provinces to build a natural gas infrastructure.

(1) In the municipal power utility category, we focused our efforts on two sites, the 250 MWe Xiaguan Power Plant in Nanjing (Jiangsu Province) and the 1,275 MWe No. 1 Power Plant in Taiyuan (Shanxi Province). The Xiaguan facility, though formally owned by the national Datang Enterprise Group, is managed and administered primarily at the provincial and municipal levels. The facility is located in the downtown area of Nanjing, the capital of Jiangsu Province and a city of 1.8 million persons (the city has an additional 3.5 million suburban residents). Jiangsu, located on the east coast of China and encompassing much of the Yangtze River Delta, is among the most prosperous and industrialized regions of the country. Industry accounts for over 77% of provincial electricity consumption and (including the power sector) 92% of coal consumption, with residential following a distant second at 11% and 4.2%, respectively.<sup>7</sup> Jiangsu is a center for numerous clusters of domestic and foreign-owned manufacturing operations, and relies primarily on coal imported from interior regions of China to meet its needs. In 2003 about 79% of the province's total coal supply was imported.<sup>8</sup> Nanjing consumes one quarter of Jiangsu's electricity supply.

Nanjing's Xiaguan Power Plant dates originally from 1910, but underwent a substantial rebuild from 1998 to 2000. Approximately 30 percent of the rebuild costs were devoted to the installation of a LIFAC (Limestone Injection into Furnace and Activation of Calcium oxide) flue-gas desulfurization system. At the time of

our research, three such systems were operating in China, two in the Nanjing facility and one in a 125 MWe power plant in neighboring Zhejiang Province. Xiaguan's system was supplied by the Finnish firm POCOTEC Pollution Control Technologies, and was financed by soft loans from the Finnish government and grants from the Jiangsu provincial government. The system produces no secondary wastewater, and the fly ash is used for road construction and cement production. The Xiaguan plant generally burns coal with a sulfur content of 1.0 to 1.5 percent. The LIFAC system has achieved a 75% sulfur removal rate, and for the first five years of operation averaged more than 95% availability. Though a loss maker commercially over the past three years—a condition not unusual for Chinese generators—the plant has become something of a model nationally for advanced emissions control.

The second case in this category, the No. 1 Power Plant on the outskirts of Taiyuan City, Shanxi Province, is a more typical facility along a number of dimensions. Taiyuan is the capital of Shanxi, a landlocked province in North China and the largest coal-producing region in the country, supplying 27% of China's coal in 2003.<sup>9</sup> Mining is far and away the largest industry in the province, though a concentration of traditional, state-owned heavy manufacturing is clustered in Taiyuan City. The province, among the poorest in China in terms of urban income, has gained notoriety as the center of some of the country's worst environmental problems, especially atmospheric pollution and acid rain. Approximately 70 percent of annual provincial production of energy resources are exported and sold to other provinces. Taiyuan City, with an urban population of about 2.3 million, consumes 40% of the province's electricity supply. The city is covered in soot and has been ranked as having the worst air quality (particulates and sulfur dioxide) of any city in the world.<sup>10</sup> In 2002, despite various regulatory efforts, reported average daily SO<sub>2</sub> concentrations in Taiyuan equaled 0.2 milligrams per cubic meter (mg/m<sup>3</sup>), over three times the PRC's Class II annual standard (0.06mg/m<sup>3</sup>).<sup>11</sup>

The Taiyuan No. 1 Power Plant, one of the largest sources of airborne pollutants in the city, went into operation in 1954, though the six units currently in operation—four 300 MWe generators, one 50 MWe generator, and one 25 MWe generator—date from the 1990s. The plant sources all its coal from within Shanxi province, and reports an inability to secure low-sulfur and low ash content coal. Flue-gas desulfurization facilities (wet limestone and gypsum spray injection systems imported from Japan) have been installed only on the 50 MWe unit and one of the 300 MWe units. The plant reports sulfur dioxide emissions of approximately 60,000 tonnes annually, about 20 percent of Taiyuan municipality's annual total. The local Environmental Protection Bureau has routinely assessed emission fines on the No. 1 Power Plant which, when combined with low tariffs for power delivered to the grid, makes the facility uneconomic. Nevertheless, the facility is planning a major expansion, involving the addition of two 600 MWe generators. This expansion is driven in part by electricity shortages both within the inland province itself and in the Northern coastal areas to which power generated by the plant is dispatched. Shanxi Province exports approximately 25 percent of its electric power to coastal areas, with generators in the province facing particular pressure to dispatch to the distant, but politically powerful cities of Beijing and Tianjin. Our team also interviewed the state-owned Shanxi Grid Corporation to examine issues surrounding dispatch.

(2) In the category of co-generation for primary power by industrial firms, the research team focused on the coastal Southern Chinese province of Guangdong, where much development of this type has taken place. Guangdong, arguably the first Chinese province to undergo economic reform, is now one of the most economically liberal and internationally integrated regions of China. The province includes a number of major manufacturing clusters, many of which emerged only after the onset of economic reform and thus have avoided many of the historically-rooted problems of China's northern and northeastern industrial

'rust belt' regions. The research team focused on two primary cases in this region.

One of the cases is a major Guangdong subsidiary of a Hong Kong-based global apparel concern. This subsidiary employs 23,000 individuals in a major production site in the city of Gaoming. The company's factories in Gaoming and nearby Yanmei consume about 170 thousand megawatt-hours of electricity and 600,000 tonnes of steam annually, accounting for 8–9% of total operating costs. The firm was confronted with electricity shortages which were constraining its expansion, and in 2001 elected to build its own 30 MWe coal-fired co-generation plant. The plant became operational in 2004. The plant burns low sulfur coal sourced from Shanxi and Inner Mongolia. Coal costs for the company have risen substantially over the last two years (from 330 RMB/ton to 520 RMB/ton), making the in-house plant's electricity costs only marginally lower than grid electricity. Unlike the grid, however, the in-house plant provides reliable energy, as well as substantial quantities of steam, which avoids the need for costly and environmentally problematic heavy oil burners.

The second self-generation case involves the Guangdong manufacturing site of a U. S. consumer products company. This firm faced similar energy constraints, albeit on a smaller scale, at its production facilities outside the provincial capital, Guangzhou. The bulk of the site's energy use is accounted for by the heating, ventilation and air-conditioning requirements of its climate-sensitive manufacturing facilities. In the last two to three years, the firm has routinely received electricity-shedding orders from the regional grid company, requiring a shift in production schedules to avoid periods of peak power consumption. The shedding orders have ranged from 30 to 70 percent of total load, thus challenging the firm's HVAC requirements and threatening its manufacturing operations. Fearing further energy-related disruptions, the firm elected to purchase dual Perkins diesel-fired generators, each rated at 1.8 MWe.

To supplement these case studies, the team conducted interviews with major multinational suppliers of diesel generators to the China market, as well as with industrial and governmental purchasers of diesel generators in North China, a region in which these generators are usually employed as back-up sources of power.

(3) Members of the research team have also undertaken a multi-year effort into the third category of energy decision-making, gas infrastructure development in coastal East China. Interviews and discussions have been conducted with a variety of involved entities, including overseas fuel suppliers, Chinese national oil and gas majors, port facility and pipeline development companies, national and local governmental development agencies, domestic bank lenders, and overseas investors. This is a large topic that extends beyond the scope of the chapter. However, we include it as an important illustration of the politics of energy-related issues in China, as an important indicator of future energy infrastructure trends in the country, and as a bridge between China's domestic energy imperatives and global energy markets.

## **CAPACITY EXPANSION IN THE ELECTRIC POWER SECTOR.**

Capacity expansion in China's electric power sector provides us with some of the clearest evidence of how energy-related decisions are actually being made on the ground. On paper, the story is straightforward. Most power plants belong to one of five major state-owned national energy corporations, enterprise groups that in theory answer upward to the central government while issuing orders downward to exert direct financial and operational control over their subsidiary plants. This chain of command should mean that for a new power plant to be built, the state-owned parent must secure the necessary central government approvals, and demonstrate that the new project meets relevant national technical standards, stipulations about what fuels to utilize, and, once the plant is up and running, national

operational requirements, including environmental regulations.

The reality, however, is far more complex. For example, as central government officials themselves acknowledge, of the 440,000 MWe of generating capacity in place at the beginning of 2005, there were about 110,000 MWe of ‘illegal’ power plants which never received construction approval by the responsible central government agency (the Energy Bureau of the National Development and Reform Commission, a part of the former State Planning Commission.)<sup>12</sup> These plants were obviously all financed, built, and put into service, but nobody at the center can be sure under what terms or according to what standards.

Local government dynamics are critical to an understanding of China’s fragmented energy governance. In China today, localities in high growth industrialized regions like the coastal provinces Zhejiang and Guangdong desperately need electricity. Local officials, long accustomed to operating in a bureaucratic system that for all its confusion has consistently emphasized the maximization of economic growth and consistently tolerated ‘entrepreneurial’ ways of achieving that goal, are the key players in power plant construction and operation. For example, the parent national energy corporations provide only about 25% of the capital required for new power plant investment. Much of the remainder comes in the form of loans from the municipal branches of state-owned banks. These banks in theory answer to a headquarters in Beijing, but in practice are likely to respond to the wishes of local governmental officials, partly because local officialdom exerts substantial control over personnel appointments within local bank branches. Another important source of capital is even more directly controlled by the locality. These are municipally-owned energy development corporations—quasi-commercial investment agencies capitalized through various fees and informal taxes levied by local government.

Thus, regardless of formal ownership ties running up to the center, power plants built for the urgent purpose of meeting local demand are often built with locally-controlled financing. It should not be surprising, then, to find municipal governments providing construction approval to get the plants online as quickly as possible, while simultaneously shielding them from the need for further approvals from the center that might well require stricter technical, environmental, or fuel standards. Similarly, parent power firms and local governments will often break apart plant investment filings in an attempt to lower artificially the plant’s recorded capacity and therefore avoid the need for central government approval. The fact that 110,000 MWe of installed capacity is ‘illegal’ means neither that the plants are hidden in a closet nor that they lack any governmental oversight. What it does mean is that they are not part of a coherent national policy, that they frequently operate outside national standards, and that they often evade control even by their ostensible owner at the national corporate level.

In this system, the lines of operational accountability and responsibility are often blurred. On the one hand, power plants that are supposed to be controlled by a parent national firm end up dealing with the parent at arms length. The parent provides some investment and working capital funds to the plant, and some profits are returned upward. In accounting terms, the financial performance of the plant is subsumed within the integrated financial statement of the parent corporation. On the other hand, financing and project approval come primarily through local agencies that are intent on ensuring power delivery regardless of the commercial ramifications for the plant or the parent group. Thus, power plants can and do operate at a loss for years on end, further complicating incentives for plant managers. Indeed, because of the lack of clarity in the governance structure these operators sometimes themselves engage in creative financial and investment strategies. Central officials acknowledge that it is not unusual for power plants to operate sideline, off-the-books generating facilities, the profits

from which can be hidden from the parent energy group and thus shielded from upward submission. As one Chinese government researcher recently observed, the electric power sector may be a big loss maker on the books, but people in the sector always seem to have a great deal of cash. Of course, the high rates of capacity increase mentioned earlier could not happen without local government compliance, if not outright encouragement. China's fastest growing cities are effectively pursuing a self-help approach to meeting their power needs, and blurred lines of governance and accountability abet them in this.

### **ENVIRONMENTAL REGULATION.**

Chinese environmental administration is also characterized by a pattern of *de facto* local governance. For example, the central government has established extensive legal restrictions on emissions of sulfur dioxide. The 1998 and 2000 amendments to China's Law on the Prevention and Control of Atmospheric Pollution set stringent national caps on total sulfur emissions and required coal-fired power plants to install pollution-reducing flue gas desulfurization systems.<sup>13</sup> To promote the utilization of these technologies, which add significantly to plant capital and operating costs, the central government imposed mandatory pollution emission fees on power plants. Yet today, the central government estimates that only about 5,300 MWe of capacity has been equipped with FGD, a small fraction of the total capacity subject to the anti-pollution laws. Another 8,000 MWe with FGD is currently under construction, but even once completed, the resulting total will still only equal about 5.4% of thermal capacity.<sup>14</sup> Even more troubling, researchers could only guess at how often the equipment is actually turned on.

Once again, the fragmented, *ad hoc* system of energy-related governance in large part explains how this could happen. Environmental policy at the national level is primarily the responsibility of the State Environmental Protection Agency (SEPA), a relatively weak

organization, though one that has been gaining authority recently. But implementation and enforcement come under the authority of provincial and municipal-level arms of SEPA. As with the local bank branches, personnel appointments in these local environmental bureaus are for the most part controlled by local governmental officials rather than by the parent central agencies. If the locality's main goal is to achieve economic growth, and cheap electric power is needed to fuel that growth, then environmental enforcement will play a secondary role. Local environmental officials who take a different view are likely to run into career difficulties. Moreover, budget allocations for local environmental bureaus are very tight, so bureau officials are often forced to resort to self-help mechanisms of financing just to survive. To keep up staffing levels and ensure that their employees are paid, they must rely either on the collection of local pollution emission fees or on handouts from the local government. In practice, this translates into incentives for local environmental regulators either to allow emitters to pollute (as long as they compensate the local SEPA office with the payment of emission fees) or to accept payment from the local government in return for ignoring emissions entirely.

### **WITHIN-THE-FENCE GENERATION.**

In the fastest-growing and most power-hungry areas of China the self-help approach goes right down to the level of the industrial enterprises that account for so much of the growth in electricity demand. In provinces like Guangdong and Zhejiang, major industrial cities have grown up out of what only recently were small towns or villages. In the absence of adequate municipal or regional power infrastructure, large numbers of manufacturers in these areas have been installing their own diesel-fired generators. The diesel fuel is expensive, and the electricity is more costly than from a large coal-fired power plant. But the factories have little choice. Many of them are tightly integrated into global production networks and are scrambling to meet overseas

demand for their products. They cannot afford to shut down for lack of power. Some of them operate sensitive production processes that do not tolerate power interruptions. The scale of such activities is considerable. In Zhejiang province, for example, it is estimated that 11,000 MWe is off-grid. China is now the world's largest market for industrial diesel generators, and the country's consumption of diesel fuel, much of it produced from imported crude, has climbed substantially. Generator manufacturers estimate that ten percent of China's total electric power consumption is supplied by these 'within-the-fence' units. Local officials have generally tolerated and in some cases actively supported such solutions, and environmental regulation of these diesel generators has lagged behind that of central station power plants.

#### **THE PATH FORWARD: COAL VERSUS OIL AND GAS.**

The complicated, fragmented governance of China's energy sector will also have a major bearing on one of the most important aspects of its future development: the relative roles of coal, on the one hand, and oil and natural gas, on the other. The vast scale of China's demand suggests that all economic energy sources, including nuclear power and renewables, will be used heavily. But in China, as in the world as a whole, fossil fuels will dominate the supply side for the foreseeable future. (China's ambitious plans for nuclear power underscore this point. If current plans come to fruition, and nuclear generating capacity is increased from its current level of about 9,000 MWe to 40,000 MWe by the year 2020, more nuclear plants will be built in China over the next 15 years than in any other country. But even then, nuclear energy will still only provide about 4% of China's generating capacity. Fossil-fired plants will account for much of the rest.<sup>15</sup>)

The inevitable dominance of fossil fuels in China is not good news for the global climate. But the severity of the problem will depend on the proportions of oil, gas, and coal in China's

future energy mix, and that is much less certain. In one scenario, China, like almost every country that has preceded it up the economic development ladder, will rapidly shift from reliance on solid fuels towards oil and gas, with gas playing an increasingly important role in electric power generation, in industrial and residential heating, and potentially also in transportation.

In an alternative scenario, China will remain heavily dependent on coal for electric power, for industrial heat, as a chemical feedstock, and increasingly, for transportation fuels, even as demand continues to grow rapidly in each of these sectors. The prospect of continued high oil and gas prices make the coal-intensive scenario more plausible today than it was during the era of cheap oil.

These two scenarios pose very different risks and benefits for China and for the rest of the world. For the Chinese, the heavy coal use scenario would have the merit of greater energy autonomy, given China's very extensive coal resources. It would also mean less Chinese pressure on world oil and gas markets. But the impact on the environment would be substantially greater, both locally and internationally. In the worst case, the heavy environmental toll inflicted by today's vast coal mining, shipping, and burning operations, already by far the world's largest, would grow much worse as China's use of coal doubled or even tripled over the next 25 years. More optimistically, China would become the world's largest market for advanced clean coal technologies, including gasification and liquefaction, and eventually also including carbon dioxide capture and storage. But these technologies will add considerably to the cost of coal use, and, in the case of carbon capture and sequestration, are unlikely to be deployable on a large scale for decades.

The high oil and gas use scenario would not prevent these problems, but it would make them more manageable. A modern gas-fired electric power plant is not only cleaner than its coal-fired counterpart, but also emits 70%

less carbon dioxide per unit of electrical output. A petroleum-based transportation system emits only about half as much carbon dioxide per barrel as it would if the liquid fuels were produced from coal. But the high oil and gas scenario would also force China, with few resources of its own, to compete ever more aggressively for access to them around the world. In that case, the recent tensions with Japan over drilling in the East China Sea and the flurry of deal making in Iran, Africa, Central Asia, South America, and elsewhere may in retrospect come to seem like a period of calm before the storm.

Much is riding, therefore, on which of these scenarios China will follow more closely. There are already some indications of which way China will go. China's coal is for the most part located inland, far from the major energy consuming regions along the coast. So a clean-coal-based development strategy would require a national-scale energy infrastructure, with large-scale, technologically-advanced, highly efficient power plants and 'polygeneration' facilities (producing a mix of chemical products, liquid transportation fuels, hydrogen, and industrial heat as well as power) located in the coal-rich areas of the north and west, and linked to the coastal regions via long-distance, high-voltage transmission networks. But although numerous demonstration projects have been proposed or even in some cases started, both participants and other domestic advocates frequently express frustration at the slow pace of development and inconsistent government support for these efforts. Despite years of deliberation, many of the highest profile projects are still held up in the planning or early construction phases.

A major obstacle is that these clean-coal-based strategies require a strong central government role, centralized funding, and substantial cross-regional coordination, all of which are lacking in China's energy sector today. Instead, China's most-developed coastal regions, rather than waiting for a national strategy to emerge, are moving forward with their own solutions. Many municipalities are simply building con-

ventional coal-fired power plants as fast as they can, often with subpar environmental controls. While they are willing to import coal from the poorer inland provinces, they are not willing to invest in the large-scale infrastructure that would make them dependent on electricity generated in those interior regions. It is commonly observed that in China everybody wants to generate power, and nobody wants to rely on others for it.

More developed provinces like Zhejiang and Guangdong, or provincial-level municipalities like Shanghai, under pressure to provide adequate power supplies but also facing growing demands by an increasingly sophisticated public for a better environment, recognize the need for cleaner approaches. However, these wealthier regions are investing not in clean coal, but rather in a burgeoning natural gas infrastructure, based mainly on liquefied natural gas (LNG) imports. In this, their interests coincide with those of the state petroleum companies, which have become significant investors in—and builders of—the infrastructure of port facilities, terminals, LNG regasification plants, pipelines and power plants, frequently partnering in these projects with the energy development arms of the municipalities and provinces. Since the viability of these investments depends on the availability of natural gas, the state petroleum companies have recently been focusing their overseas acquisition activities at least as much on gas as on oil. CNOOC's recent bid for Unocal, for example, was motivated as much or more by Unocal's natural gas reserves than by anything having to do with oil.

In effect, commercial and quasi-commercial interests at the local and national levels—almost always in cooperation with international investors—are moving China's coastal regions, if not China as a whole, down a natural gas-intensive path. Recent increases in the price of gas are playing a key role in these decisions, but that role is by no means straightforward. As noted previously, many of the key decision-makers—particularly those at the grassroots level who are influencing national policy

through ‘fait accompli’ commercial deals and investment programs—often simultaneously play the roles of policy designer, regulator, investor, commercial operator, and commercial fuel supplier. At times, their commercial stakes extend across the supply chain, from ownership of overseas fuel assets to management of shipping and logistics, investment in domestic port and infrastructural facilities and ownership of power generation. Thus, a given decision-maker may simultaneously view the prospect of higher-priced gas imports negatively from a regulatory perspective and positively in commercial terms.

In fact, more than any other players in the Chinese system, those who are participating in the gas and petroleum supply chains are the organizations with cash, commercial sophistication, links to global partners, access to global fuel supplies, and ready entrée to downstream infrastructure and major energy consumers. It is they who are making national energy policy, whether by design or—simply by virtue of the speed with which they are executing commercial strategies—by default. And none of them—not the national fuel and power firms nor the decision-makers in the leading coastal provinces—has much incentive to advocate advanced coal-based solutions or technologies. For the state petroleum firms, which increasingly see themselves as gas companies and hold substantial cash reserves, coal is a substitute for their products and the coal industry a competitor. Large-scale clean coal solutions are unlikely to be much more appealing to the national power companies, the nominal parents of most of China’s coal-burning plants. Large-scale clean coal is associated with power generation at the mine mouth, which in turn is associated with control by the mining industry, and the power companies have little interest in yielding control of their industry to mining concerns.

Finally, even though price will surely be important in the long run, powerful provincial and municipal governments along the industrialized coast, facing rapidly growing local power demand and able to draw on substan-

tial investment resources to meet it, seem at present to be opting for dependence on foreigners for gas over dependence on interior provinces for coal. The Shanghai government last year banned the construction of new coal-fired plants, while at the same time working to build an LNG infrastructure. Some coastal municipalities have little choice but to rely on coal from the interior in the near term, though even here they maintain control over power generation through the exercise of financial and regulatory power, and by building new coal plants scaled to serve only local or intra-provincial needs. However, the real trend-setters over the long term, the richer and more advanced municipalities like Shanghai, are pursuing self-help on a grand scale by investing in natural gas infrastructure. In effect, they are tying themselves to overseas natural gas supplies while maintaining a regulatory and financial stake in the downstream gas infrastructure. As they partner in these projects with national energy companies, they become at once investors, producers, consumers, and regulators of the natural gas business. This is all done in lieu of national-scale advanced coal solutions which would remove from their control not only the fuel but the power generation business as well.

## THE OUTLOOK FOR CHINA

In light of this fragmented system of governance, what can the West expect of China in those aspects of its energy development that matter most to us? What, if anything, might be done to influence China’s energy development in a favorable direction?

First, we should recognize that the Chinese government’s capacity to achieve targets for reducing hydrocarbon consumption or pollutant releases, or Kyoto-like limits on greenhouse gas emissions, is in practice quite limited. Neither louder demands for compliance by outsiders nor escalating penalties for non-compliance are likely to yield the desired results. China’s national leadership may eventually be prepared to enter into such agreements, but if



so those undertakings should be understood primarily as aspirational. China's system of energy-related governance makes the fulfillment of international commitments problematic. Nevertheless, those commitments can serve as an important source of domestic leverage for leaders seeking to strengthen internal governance in the long run.

The Chinese central government's recently announced goal of increasing national energy efficiency by 20 percent over the next five years can be understood in analogous terms. Key actors within the central government have grown increasingly aware of China's energy vulnerabilities and of the urgent need for more sustainable utilization of energy resources. Public commitments to efficiency targets, by putting the central government's reputation on the line, suggest at the very least serious aspirations—probably a necessary condition for real change to occur, though by no means a sufficient one. The question now is whether, given the nature of governance obtaining across the system—vast decentralization, ambiguous boundaries between regulatory and commercial actors, and overriding norms of economic growth maximization—there exists systemic capacity to meet the center's aspirational goals.

Second, the authoritarian nature of the Chinese state does not mean that the state itself is internally coherent or effectively coordinated. Indeed, even with regard to the recent energy efficiency targets, substantial differences of opinion persist among various agencies and actors at the central level. One result of China's particular path of reform is that the boundaries between state and non-state, public and private, commercial and non-commercial, and central and local have all become blurred. China's increasingly deep integration into the global economy is even blurring the distinction between foreign and domestic. The Chinese energy companies are majority-owned by the state (though who actually represents the state is open to debate), but they also list on overseas stock exchanges, have foreigners among their corporate directors, and receive

financing and guidance from international investment banks. As a practical matter, the number of actors exercising *de facto* decision-making power over energy outcomes in China is large, and they are not exclusively confined within China's borders. We should not reflexively invest the actions even of the ostensibly state-owned Chinese energy entities with geostrategic intent. Nor should we assume that those in the center who do think in terms of crafting a national energy policy actually can control the very large number of entities whose actions are often driving energy outcomes.

For those outside China who have a stake in the direction of China's energy development, the governance situation we have described here has both positive and negative implications. On the one hand, this is not a system that is capable of responding deftly to either domestic or international mandates, particularly when such mandates call for dramatic near-term change, and particularly when such change carries economic costs. Indeed, the response by subordinate officials to dictat from above is more likely to come in the form of distorted information reporting than actual changes in behavior. The response by local officials in the late 1990s to central mandates for closure of locally-owned coal mines—a response that generally involved keeping local mines open but ceasing to report output to national authorities—is indicative of how the system reacts to dictat. The many players, diffuse decision making authority, blurred regulatory and commercial interests, and considerable interest contestation in the energy sector combine to make dramatic, crisp changes highly unlikely. It is illusory to expect that the world's carbon problem can somehow be solved by wholesale changes in Chinese energy utilization trends.

On the other hand, this is also system in which players are emerging at every level who have a stake—whether political or commercial—in achieving more sustainable energy outcomes. That some central agencies have been able to establish more stringent national energy ef-

efficiency targets, that citizens in China's more advanced cities like Shanghai (a municipality with a per capita income comparable to Portugal's) are demanding cleaner air, and that domestic energy companies are positioning themselves commercially for an environmentally-constrained market are just some of the indicators of this. Although these players are not well coordinated, and often represent competing interests themselves, they are frequently looking outside, particularly to the advanced industrial economies, for guidance and models to emulate. Moreover, they are doing so in the context of a system that is highly integrated into the global economy, to the point that foreign commercial entities are often deeply involved in domestic decision making. This is particularly apparent with respect to corporate strategy (including the strategies of the state energy companies), investment preferences, and technology choices. In short, there may be significant opportunities, especially through commercial channels, for foreign involvement in China's pursuit of sustainable energy development.

Perhaps most important, for all its faults the Chinese system is highly experimental and flexible. Those entities that are seeking more sustainable energy solutions in many cases actually have the ability to pursue experimental projects, often on a large scale and often involving foreign players. For example, several municipalities, including Beijing itself, have taken advantage of aspects of the national Renewable Energy Law to establish cleaner, more efficient, large-scale biomass-fueled power plants. The specific terms of such projects—who pays for them, who designs and controls them, and so on—are always subject to ambiguity, negotiation, and ad hoc interpretation. This is, after all, a nation that has an institutional tolerance for “systems within systems” and a wide array of quasi-legal, gray area activities. Experiments on the sustainable energy front are certainly possible, and in some cases are beginning to happen. Those most likely to succeed will not be national in scale, but localized, replicable, and able to propagate to other localities. These experiments should also be

consistent with trends in advanced economies, and indeed, should be supported by players from those economies. China's economic and commercial development is now so dependent on global integration that it will not be an outlier in terms of its energy system.

Finally, we should recognize that China's energy system is in its own way as politically complex, fractured and unwieldy as our own. And we would be unwise to expect of the Chinese what we do not expect of ourselves.

## CHINA AND INDIA COMPARED

India, with a population almost as large as that of China (1.1 billion compared with 1.3 billion) and with a similarly rapid rate of economic growth, will also be a major contributor to atmospheric carbon emissions. Like China, India has extensive coal reserves (see Figure 2.1), and it is the world's third largest coal producer after China and the United States. Coal use in India is growing rapidly, with the electric power sector accounting for a large share of new demand. However, India's per capita electricity consumption, at 600 kWe-hr/yr, is only 35% of China's, and its current rate of coal consumption (460 million tonnes in 2005) is about a fifth that of China.

India's total installed generating capacity in the utility sector in 2005 was 115,000 MWe, of which 67,000 MWe, or 58%, was coal-fired. Coal currently accounts for about 70% of total electricity generation. (The comparable figures in China were about 508,000 MWe of total installed capacity, with coal plants accounting for over 70% of installed capacity and about 80% of generation.) In India, as in China, self-generation by industry is also a significant source of coal demand.

A large fraction of future growth in the electricity sector will be coal-based. Current government plans project growth in coal consumption of about 6%/year.<sup>16</sup> At this rate, India's coal use would reach the current level of U.S. coal consumption by about 2020, and

would match current Chinese usage by about 2030. This suggests that there may be time to introduce cleaner, more efficient generating technologies before the greatest growth in coal use in the Indian power sector occurs.

Further information on India's patterns of coal use is provided in Appendix 5.A.

## CITATIONS AND NOTES

1. IEA, *World Energy Outlook 2004*, p. 34.
2. Wei Yiming, Han Zhiyong, Fan Ying, Wu Gang (eds.). 2006. *China Energy Report (2006)*. Beijing, China: Science Press. (Zhongguo Nengyuan Baogao: Zhanlue yu zhengce yanjiu (2006), Beijing: Kexue Chubanshe).
3. Pu Hongjiu, Lu Yanchang, Lu Yaohua, Zhou Xiaoqian (eds.). 2004. *China Electric Power and Coal*. Beijing: Coal Industry Press. Zhongguo dianli yu meitan. Beijing: Meitanqiye Chubanshe. P. 309.
4. National Bureau of Statistics. 2005. *China's Economy and Trade Yearbook*. Beijing: China Economy and Trade Yearbook Press. p. 99; UNDP/World Bank Energy Sector Management Assistance Programme (ESMAP). June, 2004. "Toward a Sustainable Coal Sector in China", p. 4.
5. Wei Yiming, Han Zhiyong, Fan Ying, Wu Gang (eds.). 2006. *China Energy Report (2006)*. Beijing, China: Science Press (Zhongguo Nengyuan Baogao: Zhanlue yu zhengce yanjiu (2006), Beijing: Kexue Chubanshe). p. 12; National Bureau of Statistics. 2004. *China Electric Power Yearbook*. Beijing: China Electric Power Press p. 671; Energy Bureau, National Development and Reform Commission. November 28, 2005. "A Comparison of World and Chinese Energy Statistics". Shijie yu Zhongguo de nengyuan shuju bijiao. [http://nyj.ndrc.gov.cn/sjtj/t20051128\\_51344.htm](http://nyj.ndrc.gov.cn/sjtj/t20051128_51344.htm). <http://www.sp-china.com/news/powernews/200605110002.htm>.
6. State Council Information Office. June 8, 2006. [http://www.gov.cn/xwfb/2006-06/08/content\\_303550.htm](http://www.gov.cn/xwfb/2006-06/08/content_303550.htm)
7. National Bureau of Statistics. 2004. *China Energy Statistical Yearbook*. Beijing: China Statistics Press. p. 183.
8. National Bureau of Statistics. 2004. *China Energy Statistical Yearbook*. Beijing: China Statistics Press. p. 183.
9. National Bureau of Statistics. 2004. *China Energy Statistical Yearbook*. Beijing: China Statistics Press. pp. 34, 158.
10. National Bureau of Statistics. 2003. *China Energy Statistical Yearbook*. Beijing: China Statistics Press, p. 307.
11. Richard Morgenstern, et. al. "Emissions Trading to Improve Air Quality in an Industrial City in the People's Republic of China". Resources for the Future Discussion Paper 04-16. April 2004. p. 6.
12. A 2005 Merrill Lynch report estimated the corresponding figure at 80-140 GWe (China Daily, "Illegal Power Plants to be Cracked Down". February 15, 2005. [http://www.chinadaily.com.cn/english/doc/2005-02/15/content\\_416510.htm](http://www.chinadaily.com.cn/english/doc/2005-02/15/content_416510.htm).)
13. Richard Morgenstern, et. al. "Emissions Trading to Improve Air Quality in an Industrial City in the People's Republic of China". Resources for the Future Discussion Paper 04-16. April 2004. p. 15.
14. National Bureau of Statistics. 2005. *China's Economy and Trade Yearbook*. Beijing: China Economy and Trade Yearbook Press. p. 102.
15. Ma Kai (ed.) *Strategic Research on the Eleventh Five-Year Plan*. Beijing: Beijing China Science Technology Press. October 2005. "Shiyiwu" guihua: Zhanlueyanjiu. Beijing: Beijing kexiejishu chubanshe.
16. "Draft Report of the Expert Committee on Integrated Energy Policy". Planning Commission, Government of India. New Delhi, December 2005. <http://planningcommission.nic.in/reports/genrep/intengpol.pdf>.



## Chapter 6 — Analysis, Research, Development and Demonstration

In the United States, most of the energy supply and distribution activity, for example oil and gas production, coal mining, electricity generation, is performed by private sector firms. These firms make the massive investments required to sustain the energy system of the country and to develop and introduce new technology to the market.

Government support for this industry innovation occurs in four ways: (1) setting the rules for private sector innovation and technology deployment incentives, e.g., intellectual property protection and R&D tax credits; (2) support for basic scientific research; (3) support for pre-commercial technology and engineering development, and (4) support for demonstration projects that inform industry about the technical performance, cost, and environmental risks of a new technology. Support of pre-competitive research by government offers new technology options because private firms generally will not make investments whose benefits are not easily captured by individual firms. The rationale for later stage government support turns on other market failures or imperfections. These rationales are sometimes distorted in the political process so as to provide inappropriate subsidies, but significant learning-by-doing economies and social insurance considerations can be, under the right circumstances, sound rationales, along with other features like cost sharing.

The DOE is the primary federal sponsor of energy technology RD&D in the U.S. Because of the enormous coal resource base in the United States and the environmental challenges associated with its large-scale use, coal has been a

major focus of the DOE RD&D program for more than thirty years. We comment on the extent to which the ongoing DOE RD&D effort is providing important options for meeting the principal challenges facing large-scale coal use in the coming years and decades. We also suggest the RD&D priorities we consider to be most critical and provide a rough estimate of the needed resource commitments.

The United States and other countries will want to use coal in the future because it is cheap and plentiful. But, in order to do that, technology must be available to control carbon dioxide emissions. The challenge applies both to new power plants and to improvement or retrofit of the large installed base of PC power plants.

The United States also has an interest in coal technology deployment in the large emerging economies such as China and India, principally because these countries are major emitters of greenhouse gases. A secondary interest is the potential commercial opportunity for U.S. firms to participate in the CO<sub>2</sub> emission control programs these large developing economies may offer. For some time, developing countries will be primarily interested in coal technologies that reduce emission of pollution that affects human health and the local and regional environment. The possible synergy between control of criteria pollutants and mercury, and the control of CO<sub>2</sub> emissions is an important factor in assessing the effectiveness and balance of the RD&D portfolio.

The critical technology options for meeting the challenge of CO<sub>2</sub> emission reduction are:

- ultra-high efficiency coal combustion plants
- gasification technologies, including gas treatment
- long-term carbon dioxide sequestration
- improved methods for CO<sub>2</sub> capture and for oxygen production
- syngas technologies, such as improved hydrogen-rich turbine generators and technologies to convert syngas to chemicals and fuels
- technologies that tolerate variable coal qualities
- integrated systems with CO<sub>2</sub> capture and storage (CCS)
- novel concepts, such as chemical looping, the transport gasifier, the plug flow gasifier, membrane separation of CO<sub>2</sub>, and others
- large-scale transport of CO<sub>2</sub>, captured and pressurized at coal combustion and conversion plants, to injection at storage sites.

In addition, some large-scale demonstration is needed in the near term:

- large-scale sequestration with appropriate site characterization, simulation, measurement, and monitoring;
- integrated coal combustion and conversion systems with CCS.

### THE CURRENT DOE RD&D PROGRAM

A key question is the success the DOE RD&D program has had in providing these needed technologies in the past and its likelihood of success going forward. Our conclusion is that the DOE coal RD&D program has had some important successes over the last thirty years, but it has had some significant gaps and needs considerable strengthening and restructuring to meet the current challenges facing coal use.

Since 1978 the DOE has supported a broad effort of RD&D on advanced coal technologies

for: (a) coal processing, (b) environmental control, (c) advanced power generation, (d) CO<sub>2</sub> capture and sequestration, and (e) industrial coal applications. A number of these activities have been undertaken in cooperation with industry and other organizations such as EPRI.

Figure 6.1 presents a timeline of the major RD&D program components. Since 1978 DOE has spent about \$10 billion (2003 \$) on these activities. The **Clean Coal Technology Demonstration Program** focused on commercial scale demonstration of technologies to improve the efficiency and reduce the environmental impact of coal-fired power generation. The **Power Plant Improvement Initiative** focused on demonstrating near-term technologies for improving environmental and operational performance of the PC fleet. The current **Clean Coal Power Initiative** is directed toward demonstrating innovative technologies to help meet the Clear Sky Initiative, the Global Climate Change Initiative, FutureGen, and the Hydrogen Initiative. **FutureGen** is intended to demonstrate the first commercial-scale, near-zero-emissions, integrated sequestration and hydrogen production power plant. The Advanced Research program is designed to develop the underlying basic science and innovative technologies to support the demonstration programs.

A summary of the FY07 Administration budget request for coal RD&D is presented, along with FY06 funding, in Table 6.1. The central role projected for FutureGen is evident. The table provides a reference point for our discussion of the principal RD&D needs. We do not believe that the proposed DOE program can adequately address those needs with the proposed scale and distribution of funding.

### COMMENTS ON THE DOE RD&D PROGRAM.

**Our purpose here is to comment on the successes and gaps in the DOE's program from the point of view of producing technology options for clean coal combustion and con-**

**Figure 6.1 DOE RD&D Activity for Advanced Coal Technologies Program**

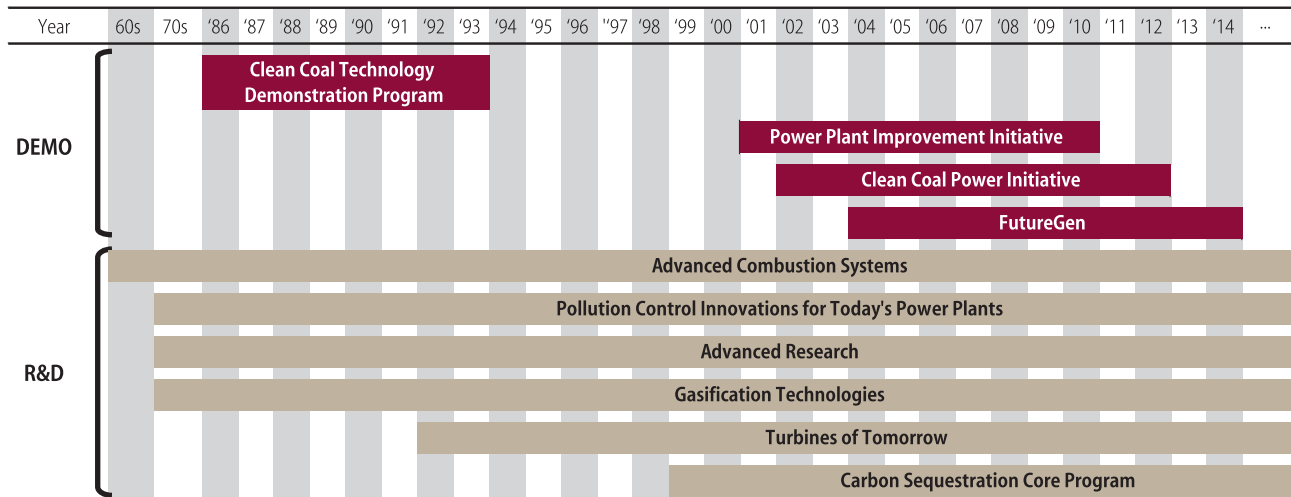

**version technology.** We do not intend to do a detailed analysis of the DOE budget, or to assess its relationship to various roadmaps developed by DOE in partnership with others, notably the Coal Utilization Research Council and EPRI (for example, the Integrated Clean Coal Technology Roadmap [2]). We do not evaluate the program in terms of return on in-

vestment [1]. We also do not address the criticism that over the years the DOE coal program has been subject to political influence on project selection, siting, and structure.

**The DOE program can be credited with a number of significant achievements.**

Table 6.1 DOE Coal RD&D Program Overview for FY06 to FY07						
	FY05, \$MM	FY06, \$MM	FY07, \$MM	FY08, \$MM	06 TO 07, \$MM	
<b>Coal Program, Total</b>	<b>342.5</b>	<b>376.2</b>	<b>330.1</b>		<b>-46.1</b>	
Clean Coal Power Initiative	47.9	49.5	5.0		-44.5	Restricted funds to force program to better use funds already provided
FutureGen	17.3	17.8	54.0	203.0	36.2	To support detailed design and procurement activities, permitting etc. to keep project on schedule for 2008
Innovations for Existing Plants		25.1	16.0		-9.1	Advanced, low-cost emissions control technology development to meet increasingly strict regulations, including mercury.
IGCC		55.9	54.0		-1.9	Advanced, lower cost, improved performance technologies for gasification, gas cleaning, oxygen separation, carbon capture
Advanced Turbines		17.8	12.8		-5.0	Advanced technology development for coal-based hydrogen turbines with low emissions
Carbon Sequestration		66.3	73.9		7.6	Focused on GHG control technologies including lower-cost CO <sub>2</sub> capture, MMV, and field testing
Fuels (Hydrogen Focused )		28.7	22.1		-6.6	Focused on R&D of low-cost hydrogen production from clean coal.
Advanced Research		52.6	28.9		-23.7	Innovations and advanced concepts that support development of highly-efficient, clean coal power plants
<b>Subtotal, Coal Research Initiative</b>		<b>313.7</b>	<b>266.7</b>		<b>-47.0</b>	
Fuel Cells		61.4	63.4		2.0	Coal-based fuel cell development
U.S./ China Energy		1.0	0.0		-1.0	

**For PC systems**, the DOE has contributed to advances in developing fluid-bed technology for power generation, and commercially demonstrating Circulating Fluidized Bed technology; demonstrating low-NO<sub>x</sub> burners, Selective Catalytic Reduction (SCR) and Selective Non-Catalytic Reduction (SNCR) for NO<sub>x</sub> control; improved Flue Gas Desulfurization (FGD) scrubbers for SO<sub>x</sub> control; and advancing mercury emissions quantification and mercury control technologies for PC plants.

**For IGCC systems**, the DOE has contributed to advances in improved syngas clean-up systems, advanced turbines (GE-H turbine, and Siemens-Westinghouse 501G), helping bring IGCC to the demonstration stage, and supporting two commercial demonstrations (Tampa Electric IGCC Project, 250 MW<sub>e</sub> and Wabash River Coal Gasification Repowering Project, 262 MW<sub>e</sub>) that provided significant information on the design and operation of utility-scale IGCC plants. As discussed in Chapter 3, in the past, the reason for support of IGCC demonstrations was to gain utility-scale experience with a technology that could be key if CO<sub>2</sub> capture would be required, although other reasons such as deep and efficient control of criteria pollutants and mercury, and polygeneration of multiple products, have also been suggested as benefits.

Public support was justified at the time as demonstration or risk reduction in integrating, at scale, the gasification/processing island with the power island. This integration posed substantial challenges: different syngas requirements from gasification applications that used coal instead of residual oil or coke as a feed stock; associated turbine operational requirements; different response times of the gasification and power components to load variations; bringing together distinct cultures for operating chemical and power plants; new design decisions concerning degree of heat and air integration, and trading off reliability concerns against operating efficiency.

Not all of these early DOE IGCC demonstration projects succeeded, but the Tampa and

Wabash plants, in particular, provided valuable information. Useful information came from learning how these plants, and two similar scale plants in Europe, overcame difficulties in achieving reliable operation. For example, the Tampa Electric project had significant cost overruns and took five years to reach reliable operation, neither of which would be acceptable for a commercial project using established technology. However the project eventually realized over 80% availability operating with a single gasifier, and over 90% with backup fuel (natural gas) to the turbine. Today, the plant is a reliable contributor to that utility's base load electricity supply, at acceptable operating cost. The lessons learned will inform future IGCC plant investment decisions, as intended in such government-supported demonstrations.

Although there are remaining concerns about capital cost and availability, our judgment is that for IGCC without CCS, the remaining risks are at a level that the private sector commonly encounters in making investment decisions on specific projects. Our judgment is supported by the formation of several industrial consortia to make commercial offers for IGCC plants without CCS. Accordingly, we see no justification for further public subsidy of IGCC plants without CCS on the basis of first-mover technical uncertainty; it is not an appropriate government role to "buy down" costs of technologies that are not directly addressing a market imperfection.

Demonstration of novel technologies is best done at the sub-system level. On the other hand, the critical step of adding CCS to an IGCC plants leads again to performance risks outside the envelope of private sector risk-taking and merits appropriately structured public support for integrated systems.

**However there have been important gaps in the DOE program — we mention four:**

- (1) **There has been too little emphasis on improvements in PC generating efficiency**, such as support for ultra-supercritical boiler and steam cycle technology. Europe and



Japan are more advanced in this technology with a number of large, ultra-supercritical units operating; in the United States, EPRI is taking the lead with DOE support.

- (2) **There is a significant lack of modern analytical and simulation tools for understanding the dynamics of complex integrated coal systems, particularly with CCS.** Moreover, it does not appear to us that the private sector has adequately developed such tools either. The result is that neither the public nor private sector has the ability to assess tradeoffs between different technology options for carbon capture efficiency, much less analyze in sufficient depth questions such as transient behavior, plant reliability, or retrofit optimization.
- (3) **The applied research and technology program has not been robust enough to support the demonstration projects or to explore potential for future innovations.**
- (4) **The DOE has been slow to support advanced technology at process development unit (PDU) scale that explores new options for coal conversion, oxygen separation, and for CO<sub>2</sub> capture.**

In our view there is a near term need for appropriately structured, publicly supported, adequately resourced demonstrations of large-scale sequestration and of integrated coal combustion and conversion systems with CCS. We comment on components of the current DOE RD&D program that address important elements relevant to this purpose.

## SEQUESTRATION

The DOE Carbon Sequestration Core Program was initiated in 1999 and has been supported with moderate but increasing funding (the proposed FY07 budget is \$74 million, an 11% increase over FY06).

The program includes activities that cover the entire carbon sequestration cycle of capture, separation, compression, transportation and storage. The program has advanced carbon se-

questration science and technology. The DOE program has promoted the formation of seven U.S. regional partnerships to build an information base for decision-making, including categorization and description of regional sources, sinks, and potential targets for pilot injections. The DOE and the State Department have established a Carbon Sequestration Leadership Forum as a platform for international collaboration on technical, regulatory, and policy issues in carbon sequestration.

**To date, the DOE CCS program has not been pursued with an urgency to establish the key enabling science and technology needed for increased coal use in a carbon-constrained world.** Importantly, developing advanced capture technologies or deployments of IGCC motivated by “capture readiness” are inconsequential if sequestration is not possible at very large scale, eventually reaching the gigatonne/year scale globally. Establishing sequestration as a practical large-scale activity requires work across the board, including science, technology, infrastructure design, regulation and international standards. None of the key technical and public acceptance issues have been addressed with sufficient intensity. The program is characterized instead by small projects, many performers (e.g., the regional partnerships), and conversations that may have the virtue of involving many constituencies, but does not grapple with answers to the hard questions.

**FUTUREGEN** Given its central role in the DOE program, we comment specifically on the FutureGen project. We support the concept of an integrated demonstration of IGCC+CCS; however, we have several concerns about this particular project structure.

First, there is continuing lack of clarity about the project objectives. Indeed, the DOE and consortium insist that FutureGen is a research project and not a demonstration project. This distinction appears to be motivated by the fact that higher cost sharing is required for a demonstration project, typically 50% or more from the private sector. However, the main purpose

of the project should be to demonstrate commercial viability of coal-based power generation with CCS; it would be difficult to justify a project of this scale as a research project. And it would probably be unwise.

The ambiguity about objectives leads to confusion and incorporation of features extraneous for commercial demonstration of a power plant with CCS, and to different goals for different players (even within the consortium, let alone between the consortium and the DOE, Congress, regulators, and others). Second, inclusion of international partners can provide some cost-sharing but can further muddle the objectives; for example, is Indian high-ash coal to be used at some point? This effort to satisfy all constituencies runs the risk of undermining the central commercial demonstration objective, at a project scale that will not provide an agile research environment.

Congress and the administration should declare FutureGen to be a demonstration project, decide what level of cost sharing is appropriate to the risk without adherence to an arbitrary historical formula, and incorporate options for “experiments” only to the extent that they do not compromise the objective of commercial demonstration of the integrated system with proven components. The project design should be optimized by analysis of tradeoffs that an investor would require. FutureGen is a complex project; its success requires clarity of purpose.

It remains to be seen whether political realities will allow DOE and the FutureGen consortium the freedom to operate without the intrusion of federal procurement rules and government cost auditing. It is crucial that the sequestration program proposed in Chapter 4 not be dependent on progress of the FutureGen project. Of course, it is preferable that FutureGen, if built, support a proper sequestration demonstration. However, the sequestration projects must be accommodated with sufficiently reliable CO<sub>2</sub> supply to multiple sites, with the choice of sites optimized to provide the public with a benchmark for implementation of large-scale sequestration.

## THE RECOMMENDED ARD&D PROGRAM

Our principal objectives in this chapter are to recommend a federally-supported coal analysis, research and development program based on the analysis in Chapters 3 and 4 and aligned with the strategic goals of enabling large-scale coal use in a carbon-constrained world and to discuss criteria for federal support of large-scale integrated demonstration projects with CCS.

## ANALYSIS AND SIMULATION.

Powerful engineering-economic simulation tools are needed for analysis of integrated coal combustion and conversion systems, with CCS, under a variety of system configurations and operating conditions. This should be a very high priority in the DOE research program. We were struck many times in carrying out this study how the absence of such tools prevents reliable quantitative examination of many key questions, especially (though not exclusively) for gasification systems. A number of point designs have been studied in detail, but all are based on different assumptions and inputs. Robust models suitable for assisting large-scale engineering design should start with high-fidelity simulation of engineering-scale components and proceed to system integration for both steady-state and transient situations, including sub-systems with different dynamic characteristics (such as chemical process and power sub-systems). In order to avoid mismatch between system components, the transfer function, the time resolved relation of an output variable to load variation, would need to be determined for elements of the system. Such a modeling and simulation capability will permit the exploration of important design tradeoffs, such as between carbon capture fraction and system response to grid requirements, or degree of gas cleanup and both turbine operation and sequestration requirements, and many others. The simulation tools should flexibly accommodate validated engineering and cost data.

We estimate \$50M/year is needed to support a strong program.

## PC POWER GENERATION R&D

With the very large PC fleet in place (~325 GW<sub>e</sub> in the U.S.) and the expected additions to this fleet over the next two decades, the possibility of imposition of a significant carbon emission charge indicates the need both for ultra-high efficiency and for much less costly CO<sub>2</sub> capture technology for PC combustion plants. Success in both could dramatically alter the relative cost of PC and IGCC with capture. The higher efficiency gains will come from operating at higher steam pressures and temperatures and thus require developing higher-strength corrosion-resistant materials and advanced fabrication technologies.

Reducing capture cost appreciably is especially important for PC plant retrofits; this calls for an integrated research effort starting with CO<sub>2</sub> chemistry and physical properties, combined with a theoretical and experimental program focused on designing (or identifying) absorbents or adsorbents that can effectively capture CO<sub>2</sub> and then release it with a much lower energy requirement than present solutions. Other approaches, beyond absorbents and adsorbents, should also be explored in a basic science program.

Oxy-fuel coal combustion appears to offer significant potential for new plants or retrofit CO<sub>2</sub> capture applications and is moving towards demonstration with a pilot plant under construction in Germany (30 MW<sub>th</sub>) by Vattenfall. If successful, Vattenfall intends to build a 300-600 MW demonstration plant. SaskPower (Canada) has also announced its intention to build a 300 MW oxy-fuel power plant. Basic research to develop less costly oxygen separation technologies is a high priority, one that will also lower the cost of gasification systems. One attractive possibility for oxy-fuel combustion is to compress the entire flue gas stream (minus the water, which is relatively easy to remove) to CO<sub>2</sub> supercritical conditions, assuming the entire stream could be transported and injected as-is into a geologic formation. Much research is needed on the compositional requirements for pipeline transport as well as for

injection into geologic formations, on process design and evaluation studies, and on process development units.

Thus, key elements of a PC power generation R&D program include:

- An R&D program to develop the next level of high-strength materials along with cost-effective fabrication technologies for ultra-supercritical (USC) PC operation beyond the current USC conditions (> 1250 °F). This effort should build on the European and Japanese USC programs and current U.S. efforts.
- A significantly increased, broadly-based, coordinated R&D program on CO<sub>2</sub> capture and recovery systems, aimed at developing more cost effective and energy efficient CO<sub>2</sub> capture systems.
- An integrated design and PDU program on oxy-fuel combustion, coordinated with related activities in Europe, Canada, and Australia, including oxygen separations research and a focused effort to understand the impact that other components in the supercritical CO<sub>2</sub>, such as SO<sub>2</sub>, could have on the geologic formations into which they are injected and on injectivity.
- A program to evaluate (via focused design studies) and provide data specific to oxy-fuel PC retrofit technology should be initiated. A retrofit demonstration could offer an opportunity to produce CO<sub>2</sub> for a major sequestration demonstration (as discussed below).

We estimate \$100M/year as appropriate for this program.

## IGCC POWER GENERATION R&D.

IGCC presents a different set of issues from PC generation because IGCC currently appears to offer, at least for high rank coals, the lowest COE with CO<sub>2</sub> capture if efficiency and availability are high. Availability centers on the gasifier, on turbine operation with hydro-

gen-rich gas, and on integrated operation of the IGCC power plant with capture. Unlike PC generation where the basic boiler design is relatively homogeneous, gasifier designs are quite heterogeneous with 5 to 10 major types that could eventually become commercial. Some key elements required for a gasification R&D program are:

- Pressing the limits of syngas clean-up to reduce emissions to very low levels could help gain acceptance for IGCC without and with capture.
- Development of turbines for hydrogen-rich syngas is particularly important to the success of IGCC with CO<sub>2</sub> capture.
- Improved coal injection technologies, refractory improvement or elimination, and instrumentation developments to facilitate operational analysis and control will enhance availability.
- Research into the processing in gasifiers of widely different coal types, including sub-bituminous coals and lignites, should be evaluated aggressively. This should include basic research for novel concepts and PDU-scale evaluation of promising technologies, combined with rigorous simulation and economic analysis. Advanced power cycles with high efficiency potential are an area of interest.
- System integration studies of electricity production with fuels, chemicals, and/or hydrogen production, with CCS, should go forward, initially through simulation.
- Basic research and PDU-level studies of syngas conversion should be supported more strongly.
- Research on advanced technology concepts related to IGCC should be expanded.

We estimate \$100–125M/year as supporting a strong program.

## CO<sub>2</sub> SEQUESTRATION RD&D

The priority needs for a sequestration R&D program are discussed in detail in Chapter 4. Because of the close integration of research and demonstration in the case of sequestration RD&D, these will be considered together. The key elements identified in Chapter 4 were:

- Detailed, “bottom-up” geological assessments of storage capacity and potential for injection rates. This should also include a risk analysis of potential geologic storage regions.
- An expanded and accelerated R&D program that includes simulation, testing, and integration of MMV technologies that should be employed in major geologic sequestration demonstrations and in commercial storage programs.
- Development of protocols and regulatory structures for the selection and operation of CO<sub>2</sub> sequestration sites and for their eventual transfer of liability to the government after a period of good practices is demonstrated. We stress the urgency of research in these areas, including development of viable options for setting international standards and monitoring mechanisms.
- Several large-scale injections within key plays and basins of the U.S. These need to be of the order of 1 million tons CO<sub>2</sub>/year over several years with a substantial suite of MMV technologies employed to enable a quantitative understanding of what is happening and to identify the MMV tools that will be most effective in commercial operation. These will need major sources of CO<sub>2</sub>. To maximize effectiveness of the sequestration studies, sources for the first projects should be “on demand” sources to the extent practical (i.e., if appropriately sized and located), such as natural sources, industrial by-products (e.g., from natural gas processing plants or refineries), or CO<sub>2</sub> captured from a flue gas slip stream at a large operating coal PC plant. Subsequently, the CO<sub>2</sub> source could be purchased from a demonstration plant that advances the knowledge base for advanced coal technologies with capture.

We estimate that \$100M/year is needed for this program in the research phase, with another \$75M-100M/year required for the full suite of sequestration demonstration programs (assuming pure sources of CO<sub>2</sub> are readily available, as incorporated into the Chapter 4 cost estimates).

## ADVANCED CONCEPTS

A healthy R&D program needs a component that invites competitive proposals for basic research and innovative concepts that could lead to breakthroughs for high efficiency, clean, CO<sub>2</sub> emission “free” coal use, or for new sequestration approaches. The transport gasifier and chemical looping, mentioned in Chapter 3, are examples. New system ideas, such as integration of fuel cells with IGCC, is another example.. The program should be sufficiently large to allow for evolution of promising research results into pilot scale facilities. This is analogous to the role of the Advanced Research component of the DOE program. However, this program appears headed for reduction.

We estimate that \$100M/year would be appropriate for an advanced concepts program with the work carried out by universities, national labs, and industrial research organizations.

**In total, we estimate that an appropriate AR&D program would require funding at about \$500-550M/year.** This includes the large-scale sequestration demonstrations when they are ready to proceed, again assuming readily available pure CO<sub>2</sub> sources. The \$500-550M/year we propose should be compared to the \$215M included in the FY07 DOE coal R&D budget (excluding Future-Gen), which furthermore is in decline.

## COAL TECHNOLOGY DEMONSTRATION PROGRAMS WITH CCS

For power production, IGCC is the leading candidate for CCS using current technologies,

at least for higher rank coals. Consequently, starting a demonstration program with IGCC with CCS, as the DOE is doing with Future-Gen, is a reasonable choice. Even so, a key question, to which we will return later in this chapter and again in Chapter 8, is how the government can best stimulate and support such a demonstration project.

We have stated before the technical challenges that justified, in the past, public assistance for the first-of-a-kind plants without CCS. When CCS is added, the new plant faces significant additional challenges compared to an IGCC without CCS: different operating

conditions (such as higher pressure to facilitate capture), syngas shift reactors and hydrogen-rich gas for the combustion turbine, operation of the capture system, and interface with the sequestration operations. The purpose of federal support for an integrated system demonstration is to gain information on the cost and operability of the system and to disseminate the results, and not to risk the value of system demonstration by employing individual subsystem components for which there is little experience.

IGCC with CCS is a technically challenging, first of a kind activity that, because of its potential importance to coal utilization in a carbon-constrained world, deserves federal support. The objective of such support is to encourage timely deployment by absorbing some of the risk, but yet leaving sufficient risk with the private sector so as to distort commercial imperatives as little as possible. This suggests removing, to the extent possible, peculiarities of government administered projects: use of federal procurement rules, special requirements for government cost auditing, an annual appropriations cycle for financing the multi-year project and the technical capability of DOE personnel to manage the project, as a commercial entity. Moreover there is the reality that the federal government has “deep pockets”, so it is important to assure that federal sponsorship does not invite poor project design on the part of private sector

entities because of a reduced cost for delay or failure. There are many possible mechanisms for avoiding these frailties of DOE managed commercial demonstration projects, for example, significant cost-sharing (such as the earlier CCTP program required) and indirect mechanisms, such as a tax credit or guaranteed purchase for electricity produced or CO<sub>2</sub> captured.

While IGCC may sensibly be the first major demonstration project with CCS, we emphasize that it is only one of several possible projects needed to demonstrate the readiness of coal conversion technologies that control CO<sub>2</sub> emissions. For power production, a number of developments may give impetus to other utility-scale demonstrations with CCS: advances in carbon capture from flue gas or in oxygen separation; and the improved understanding of PC retrofit possibilities, with or without oxy-firing. Beyond this, coal conversion to chemicals, synthetic natural gas, or fuels, with CCS, could provide significant pathways to displace oil and natural gas use with an abundant domestic resource, and may offer opportunities to provide sufficient captured CO<sub>2</sub> to sequestration projects at costs significantly less than those for power plants. The central criterion for embarking on such government-assisted commercial demonstration projects is that one can reasonably expect, based on the available technologies and their straightforward extensions, that the products — electricity or otherwise — can be economically competitive in a world that prices CO<sub>2</sub> emissions. It should be clear that the absence of previous commercial demonstrations of any specific technology is not in itself a valid reason for public support.

What will this cost? The answer is project specific. However, a ballpark estimate can be provided for a portfolio of projects by the expected incremental cost of “buying” CO<sub>2</sub> from the various projects at a cost that makes the projects whole commercially, including a risk factor. One can anticipate the CO<sub>2</sub> “price” being in the range \$10-\$60/tonne-CO<sub>2</sub> depending on the nature of the project, with the highest price corresponding to purchase of CO<sub>2</sub> from

amine capture from an existing PC plant, and with the lowest price corresponding to some coal to chemicals plants. Accounting for up to five projects of different types (power, fuels, chemicals, synthetic gas; new plants, retrofits) of ten year duration, at a million tonnes CO<sub>2</sub> each, leads to about \$2B over ten years. Adding a risk factor for performance of the underlying technology suggests perhaps \$3B over ten years as a crude estimate, an average comparable to but less than that of the recommended AR&D program. It is important that the U.S. government begin thinking about such a portfolio of demonstration projects and not be singularly focused on any one project, such as FutureGen.

**At an average of \$300M/year for demonstrations, the total coal AR&D program could reach \$800-850M/year if all plant and sequestration demonstrations were running simultaneously (which is not likely).** This level corresponds to less than half a mill per coal-generated kilowatt-hour.

As discussed in Chapter 4, we see a need for at least three major sequestration demonstrations in the United States, each of which requires a substantial source of CO<sub>2</sub>. It would be ideal if the CO<sub>2</sub> capture demonstration plants were the source of the CO<sub>2</sub>. However, there are timing issues in such a scenario. The sequestration projects need “on demand” CO<sub>2</sub> to maximize scientific value and minimize cost of the sequestration project. The demonstration projects will produce CO<sub>2</sub> subject to uncertainty, from availability of first-of-a-kind systems to the vagaries of grid dispatch for power plants. Accordingly, it is likely that a mix of CO<sub>2</sub> sources will be needed for the sequestration demonstrations, from relatively high-priced sources that are “on demand” from existing base load PC plants to lower-priced, but less reliable sources from new coal technology demonstration plants with CCS. Furthermore, it may be that some CO<sub>2</sub> captured in the demonstration projects will be released due to a mismatch in CO<sub>2</sub> supply and demand between the coal conversion and sequestration facilities. While undesirable, this

possibility should be accommodated as part of the technology demonstration need to explore a wide range of coal combustion and conversion technologies with CCS in a timely way.

In Chapter 8, we discuss and recommend other approaches to federal assistance to coal combustion and conversion plant demonstrations and to large-scale sequestration demonstrations that may lead to more effective execution of future system demonstrations.

## CITATIONS AND NOTES

1. Energy Research at DOE: Was it Worth It? Energy Efficiency and Fossil Energy Research 1978 to 2000. 2001. National Research Council.
2. NETL, *Clean Coal Technology Roadmap-Background Information*. 2003, NETL.
3. DOE, *Tampa Electric Polk Power Station Integrated Gasification Combined Cycle Project*. 2002, U.S. DOE: Morgantown, WV.





## Chapter 7 — Public Attitudes Toward Energy, Global Warming, and Carbon Taxes

Any serious efforts by government or industry to address greenhouse gas emissions and global warming in the near term would impose a price or charge on carbon or constrain the use of CO<sub>2</sub>-emitting fuels in some manner. The primary policy instruments available include restrictions on emissions, stricter regulation of the use of coal and other fossil fuels, subsidies for carbon-free fuels, such as nuclear, wind, biomass, and solar power, tradable rights to carbon emissions (called cap-and-trade systems), and direct carbon taxes. Price-based mechanisms, such as carbon taxes and cap-and-trade systems, would translate immediately into higher energy prices, as they are designed to incorporate the cost of greenhouse gas emissions in the price of electricity, fuels and other forms of energy. Regulations on fuel use and emissions would increase the cost of producing energy from coal and other carbon intensive sources. Subsidies would ostensibly lower the price of energy, but they would only do so through other forms of taxation, such as income and capital taxes, which should then also be considered as part of the price of energy. Moreover, by failing to incorporate the cost of carbon emissions into energy prices this approach would dilute incentives for consumers to invest in energy efficiency and to curtail energy use (e.g. drive more miles). By placing a price on CO<sub>2</sub> emissions, public policies could lead consumers to reduce their use of CO<sub>2</sub>-emitting forms of energy and increase the competitiveness of less carbon-intensive fuels.

Policies that produce higher fuel prices have long been thought to be politically infeasible because the public reputedly reacts more

negatively to higher fuel prices or taxes than to the threat of global warming. If true, only subsidies would be politically palatable. Public opinion research has documented increasing concern about global warming in the United States, but such research only addresses half of the issue.<sup>1</sup> How will the public react to higher energy prices were the government to follow an aggressive policy to stem greenhouse gas emissions?

Here we offer an assessment of one such option, a carbon charge that, however imposed, would be equivalent to a tax on CO<sub>2</sub>-emitting energy forms. We focus on carbon taxes because research that compares the efficiency of alternative policy mechanisms to control greenhouse gas emissions concludes that carbon taxes and cap-and-trade systems offer the most efficient approaches.<sup>2</sup> Subsidies, emissions restrictions, and regulations on fuel use are much less efficient. Public attitudes about carbon and fuel taxes are more readily studied because taxes are more transparent to the public than the prices resulting from cap-and-trade systems and require less explanation. Carbon taxes, because of their transparency, are thought to be especially unpalatable politically, and public reaction to taxes therefore offers a conservative gauge of support for this line of policy-making. Economic analyses sometimes dismiss taxes as an instrument at the outset because of perceived public hostility toward taxes, though it should be noted that industrial nations have long histories of fuels taxes but have only recently experimented with tradable pollution rights.<sup>3</sup> Little opinion research addresses the willingness to pay for global warming and specific ways that such a

tax could be implemented. Of particular interest are proposals to couple higher fuel taxes with lower income, payroll, or capital taxes.

There is, in fact, widening support for concrete government policies to avoid global warming. Beginning in 2003 we conducted a series of public opinion surveys designed to gauge concern about global warming and public willingness to pay much higher fuels taxes in order to reduce greenhouse gas emissions. In October 2003 and again in October 2006, we fielded a national random sample survey of 1200 adults to measure understanding of the carbon cycle, concern about energy, the economy, and the environment, and preferences over a range of technologies and policies to mitigate carbon emissions. Two separate surveys, conducted in May 2006 and November 2006, probed opinions about proposals to use the revenues from higher fuel taxes to reduce income taxes. All four surveys consist of national random samples of U. S. adults. See appendix for details, or consult the MIT Public Opinion Research and Training Lab <http://web.mit.edu/polisci/portl/detailpages/index.html>.

Four important survey results underlie our belief that public support is growing for policy measures that deal squarely with greenhouse gas emissions and climate change.

### **1. The American public increasingly recognizes global warming as a problem.**

Three years ago, global warming ranked as the sixth most important environmental problem in our survey, behind problems such as clean water, clean air, and endangered species. Only 11 percent of respondents chose global warming from a list of 10 environmental problems as the most important environmental problem facing the country, another 9 percent ranked it second. Today, the public rates global warming as the top environmental problem facing the country. In October 2006, 35 percent of respondents identified global warming as the most important environmental problems facing the country, outpacing all other issues considerably. An additional 15 percent chose

it second. Fully half of the American public now puts global warming at the top of the U.S. environmental agenda compared with just 20 percent three years ago.

### **2. Over the past three years, Americans' willingness to pay to solve global warming has grown 50 percent.**

In 2003 and 2006 we asked survey respondents the same series of questions designed to elicit willingness to pay: "If it solved global warming, would you be willing to pay \$5 more a month on your electricity bill?" Of those who answered yes, we then asked whether they would pay \$10 more, and offered progressively higher amounts — \$25, \$50, \$75, and \$100. In 2003, support for such a tax was quite low. The median response was only \$10, and the average amount came to just \$14.

As interesting as the levels of support for the taxes are the changes over time. We repeated the survey in 2006 and found a 50 percent increase in willingness to pay. The median response was approximately \$15 more a month (or a 15 percent levy on the typical electricity bill), compared with just \$10 in 2003. The average amount came to \$21 per month. The rising amount that the typical person would pay was matched by a decline in the percent unwilling to pay anything. In 2003, 24 percent of those surveyed said they were unwilling to pay anything. Three years later, a similarly constructed sample answered the identical series of questions, and the percent unwilling to pay anything fell to 18 percent, a statistically significant drop.

The rise in willingness to pay resulted in large part from the increased recognition of the importance of the problem. The percentage of those who consider global warming a top-tier environmental concern rose from 20 percent to 50 percent. Those who did not rank global warming as one of the top two environmental problems in 2006 were willing to pay, on average \$16 per month in 2006, while those who did rank global warming as one of the top environmental concerns in the country

were willing to pay \$27 a month. In addition, willingness to pay among those who are concerned with this problem has risen considerably. Among those who consider global warming one of our chief environmental problems willingness to pay rose from \$17 a month in 2003 to \$27 a month in 2006. If global warming continues to rise as a concern, we expect to see growth, possibly very rapid growth, in willingness to pay fuel taxes that target greenhouse gas emissions.

While we would caution about interpreting firmly the level of the amount because people often exaggerate their willingness to pay, the dramatic growth in the percent of people concerned with the problem and the amount that they are willing to pay reveals a considerable growth in public recognition of the problem and support for serious policies designed to solve it.

### **3. Today the public views global warming equally compelling as oil dependence as a rationale for fuel taxes.**

Since the oil price shocks of the 1970s, lowering dependence on foreign oil has served as an important objective for U. S. energy policy. Global warming represents quite a different goal, though a tax on gasoline and other petroleum products would still be implied. Another way to appreciate the priority of global warming for the American public is to compare support for fuel taxes when oil dependence is the question and when global warming is at issue.

In a separate survey conducted in November 2006, we sought to contrast oil imports and global warming as motivations for higher energy prices. We asked half of the sample (randomly chosen) whether they were willing to pay higher gasoline taxes in order to reduce oil imports; we asked the other half of the sample whether they would pay an equivalent tax in order to reduce greenhouse gas emissions. The distributions of responses were very similar, and statistically not distinguishable. Twenty-four percent were willing to pay \$1.00 per gallon if it reduced oil imports by

30 percent (a very optimistic figure); 60 percent were opposed. Twenty-one percent said that they would pay \$.50 per gallon and \$25 per month more on electricity if it reduced U. S. greenhouse gas emissions 30 percent; 62 percent were opposed.<sup>4</sup> Further variations on these questions yielded the same result. Global warming and oil importation appear to present the typical person with equally strong rationales for higher fuel taxes.

### **4. Tying fuel tax increases to income tax reductions increases public support for high fuel taxes.**

Rising public concern and willingness to pay signal some optimism that public will to address global warming will solidify soon. The carbon tax levels that Americans support, however, fall short of what may be needed in the short run to make carbon capture and sequestration feasible, let alone other alternative energy sources such as nuclear, wind and solar. Our assessment in Chapter 3 suggests that a carbon charge in the range of \$30 per ton of CO<sub>2</sub> is necessary to reduce U. S. carbon emissions significantly and to reduce worldwide emissions of greenhouse gases. If consumers bore that cost directly, it would amount to \$13.50 per month on a typical household electricity bill.<sup>5</sup>

The total cost to consumers also depends on how the revenues raised by the carbon charge are distributed. Early economic writing on carbon taxes argues that they be revenue neutral, that is, the revenue from carbon taxes would be used to reduce payroll or capital taxes. A fuel tax could be structured to reduce income taxes and even to offset the regressive incidence of the fuel tax itself.

Swapping income taxes for fuel taxes has considerable public appeal. We tested support for fuel taxes in isolation and when tied to reductions in other taxes in national sample surveys conducted in May 2006 and November 2006. In May 2006, we asked people whether they would support a \$1.00 per gallon gasoline tax and a \$25 per month electricity charge. Only

9 percent said yes, and 72 percent said no, the remainder being unsure. When that same tax was presented with an equivalent reduction in income taxes for the typical family, support for the tax rose to 28 percent, and only a minority (47 percent) expressed opposition. In November 2006, as mentioned above, we asked a national sample whether they would support a \$.50 per gallon gasoline tax and \$25 per month electricity tax: 21 percent said yes; 17 percent, unsure; 62 percent, no. We paired the same proposal with a reduction in income taxes by an equivalent amount: 34 percent said yes; 23 percent, unsure; and 43 percent, no.

We followed up these questions by asking those opposed, why they did not support the tax swap. Only 10 percent stated that they opposed the fuel tax because the government would not also cut income taxes, and 18 percent said they could not afford to pay the tax. By far the most common answer (of roughly one in four of the 43 percent of those opposed) was that global warming is not a problem. This amounts to 10 percent of the public unwilling to pay because they view the claims about global warming to be exaggerated or unfounded. Another 20 percent of opponents thought that we could reduce global warming without the taxes. Approximately half of those opposed to the tax relied on a rationale that either denied the problem or thought that the solution could be implemented without the tax.<sup>6</sup>

We do not claim to have measured the magic number—the carbon charge that a majority of the public would unquestionably support. Rather, this series of surveys suggests that public opinion on global warming is changing and changing in ways that make a more substantial climate policy politically attainable.

Carbon taxes serve as a reference case. They are an efficient way to incorporate the costs of global warming in the price of energy, but they have been viewed as politically impossible owing to the unpopularity of taxes. While other price-based policy instruments, such as a cap-and-trade system, may not be perceived as a tax, they would have the same effect on energy prices.

Most encouraging, though, is the trend. Public discussion about global warming over the past three years has made a noticeable impact on public willingness to deal with this problem even through what is supposedly the least popular instrument, taxes. Willingness to pay has grown fifty percent in just 36 months. That growth is directly attributable to the increasing number of people who view global warming as one of the nation's top environmental problems. It also reflects a growing reality that global warming is as important as oil importation in the way the U.S. public thinks about public policy issues involving energy.

## CITATIONS AND NOTES

1. Jeffrey Kluger, "Global Warming Heats Up" *Time* April 3, 2006, vol. 167, no. 4, page 25.
2. The observation that carbon taxes offer an efficient mechanism dates at least to 1990; see James Poterba, "Tax Policy To Combat Global Warming: On Designing a Carbon Tax," in *Global Warming: Economic Policy Responses*, Rudiger Dornbusch and James Poterba, eds. Cambridge, MA: MIT Press, 1990. For an excellent survey see James Poterba, "Global Warming Policy: A Public Finance Perspective" *Journal of Economic Perspectives* vol. 7, Fall 1993, pages 47-63. Subsequent analyses point out the importance of recycling revenues to reduce taxes on labor and capital. See A. Lans Bovenberg and Lawrence Goulder, "Optimal Environmental Taxation in the Presence of Other Taxes: General-Equilibrium Analyses." *American Economic Review*. Vol. 86 (September 1996), pages 985-1000, and A. Lans Bovenberg and Lawrence Goulder, "Neutralizing the Adverse Industry Impacts of CO<sub>2</sub> Abatement Policies: What Does It Cost" NBER Working Paper No. W7654, April 2000.
3. For example, see Poterba, "Tax Policy to Combat Global Warming," op cit., pages 72-75, and Bovenberg and Goulder, "Neutralizing the Adverse Industry Impacts of CO<sub>2</sub> Abatement Policies," op cit., pages 1-3. There are other political aspects to the choice of policy instruments, especially support or opposition from affected interests and the credibility of the government in setting up a program. The cap-and-trade system for sulfur dioxide reflected the political coalitions that supported and opposed the legislation. See Paul Joskow and Richard Schmalensee "The Political Economy of Market-Based Environmental Policy: The U. S. Acid Rain Program." *Journal of Law and Economics* vol. 41 (1998), pages 37-83.
4. The amount of reduction was selected in consultation with those managing the EPPA model, see Ch. 2. We kept the 30 percent figure in both versions of the question so that people focused on a similar number, which psychologically suggests an equivalence between the two savings. We do not imply any real equivalence here.
5. This calculation assumes 1 tonne CO<sub>2</sub> per MWh for coal-fired generation and half that amount for gas-fired generation, and that about half the hours would reflect the carbon cost of gas generation and the other half that of coal-fired generation. Average household use is estimated at 600 kwh/mo.
6. The remaining respondents thought that the tax should not be on fuels but on oil companies or that the income tax cut was unfair, or that this just wasn't a good reason for a tax.



## Chapter 8 — Findings and Recommendations

Here we present our findings and recommendations from the analysis presented in prior chapters. The central message is:

*Demonstration of technical, economic, and institutional features of carbon capture and sequestration at commercial scale coal combustion and conversion plants will (1) give policymakers and the public confidence that this carbon mitigation control option is practical for broad application, (2) shorten the deployment time and reduce the cost for carbon capture and sequestration should a carbon emission control policy be adopted, and (3) maintain opportunities for the use of coal in a carbon constrained world in an environmentally acceptable manner.*

Our basic finding that serves as the underpinning for many of our recommendations derives from the technical assessment reported in Chapter 3:

*Finding #1:* Although possible in principle, it is very unlikely that any process that produces electricity from coal conversion/combustion with carbon capture will ever be as cheap as coal plants without CO<sub>2</sub> capture. Thus the cost of electricity from coal with capture will be significantly higher than it would be without CCS. Disciplined technology development and innovative advances can, however, narrow the cost gap and deserve support.

CO<sub>2</sub> capture requires that the steps that extract energy from coal either in the form of heat or by chemical transformation permit efficient separation of CO<sub>2</sub> to a form that can be transported efficiently to storage sites. This almost

certainly requires a process more complicated than simple coal combustion in air.

### FUTURE COAL USE

In Chapter 2 we used the MIT EPPA model to explore the impact on coal use of different economic assumptions including, in particular, a carbon charge imposed on CO<sub>2</sub> emissions either directly by a tax or indirectly through the market price of carbon emissions permits in the context of a cap and trade system. The EPPA model is most useful in illustrating the interconnected consequences of different policy measures, but its limitations should be kept in mind. The model shows that a significant reduction of carbon emissions is possible only when a significant price is placed on CO<sub>2</sub> emissions. The economic adjustment to the carbon emission charge includes higher end-user energy prices, less energy use, a shift to lower carbon-emitting sources of energy, including nuclear power, and importantly, if the carbon charge is high enough, coal combustion with CCS:

*Finding #2:* A global carbon charge starting at \$25 per ton of CO<sub>2</sub> emitted (or nearly \$100 per tonne of carbon), imposed initially in 2015 and rising at a real rate of 4% per year, will likely cause adjustments to energy demand, supply technologies and fuel choice sufficient to stabilize mid-century global CO<sub>2</sub> emissions from all industrial and energy sources at a level of 26 to 28 gigatons of CO<sub>2</sub> per year. Depending on the expansion of nuclear power, the use of coal increases from 20% to 60% above today's level, while CO<sub>2</sub> emissions from coal are

reduced to half or a third of what they are today. This level of carbon charge implies an increase in the bus bar cost of U.S. electricity on average of about 40%, or about 20% of the retail cost. A significant contributor to the emissions reduction from coal is the introduction of CCS, which is utilized as an economical response to carbon charges at these levels. In the EPPA model simulations, approximately 60% of coal use employs CCS by 2050 with this carbon charge.

This finding assumes that the entire world adopts the same carbon charge. As discussed in Chapter 2, if the United States or developing economies do not adopt a carbon charge (or effectively reduce their emissions of CO<sub>2</sub> significantly below business-as-usual (BAU) levels through other means), worldwide CO<sub>2</sub> emissions from coal use will not stabilize. Our examination in Chapter 5 of the patterns of energy use in China and India shows how challenging it will be for these emerging economies to reduce their emissions significantly below business-as-usual levels. With respect to China:

*Finding #3:* China's focus on economic growth and the decentralized and fragmented character of the financial and environmental governance of their fuel, power, and industrial sectors suggests that it will be some time before China could adopt and effectively enforce a policy of significant carbon emission reduction from BAU levels.

However our analysis also showed that if developing economies (of which China is the largest example) were to delay adopting a CO<sub>2</sub> charge or equivalent with a modest lag (say, ten years) relative to the developed economies, the 'penalty' in terms of additional CO<sub>2</sub> emissions compared with the case of simultaneous global compliance would be relatively small: between 100 and 123 gigatonnes of CO<sub>2</sub> emitted during the 50 year period 2000–2050 compared to total cumulative global emissions during this period of about 1400 gigatonnes CO<sub>2</sub>.

*Finding #4:* There is a relatively small CO<sub>2</sub> emission penalty associated with a modest lag in the adoption of a global carbon charge by developing economies as long as the United States and other developed countries adopt a credible CO<sub>2</sub> control policy that is consistent with the CO<sub>2</sub> prices identified here. The practical significance of this model result is the interesting opportunity for negotiating a global agreement featuring delayed adherence to a carbon charge for developing economies.

We see no evidence of progress towards a political framework that will result in convergence of the carbon emission policies of developed and developing economies. Whether or not a carbon charge is imposed sooner or later, **it is important that coal combustion is as thermally efficient as makes economic sense over the life of the plant.** This leads to our first recommendation:

*Recommendation #1:* New coal combustion units should be built with the highest thermal efficiency that is economically justifiable. Any carbon charge will make the economics of higher efficiency coal plants more attractive than those of lower efficiency plants. In addition, continuous advances in R&D make it likely that further reductions in heat rates will be possible. **For pulverized coal plants** this means super critical pulverized coal (SCPC) plants today and ultra-super critical pulverized coal (USCPC) plants soon. A 500 MWe USCPC plant will emit about 100 tonnes per operating hour less than a sub-critical plant, avoiding about 21% of the CO<sub>2</sub> emissions. [See Chapter 3, Table 3.1]. **For IGCC plants** this means attention to higher efficiency and high availability operation.

## CARBON SEQUESTRATION

As explained in Chapter 2, if CSS is available at large scale and adopted worldwide, increased coal use to meet the world's pressing energy needs in a carbon constrained world will not



increase CO<sub>2</sub> emissions, and this technology option can allow more effective constraints to be imposed on CO<sub>2</sub> emissions. This prospect assumes that CCS is implemented in a technically responsible manner at acceptable cost and, most importantly, that sequestration is demonstrated to a point where it is acceptable to the public. As discussed in Chapter 4, we find:

*Finding #5:* Current evidence indicates that it is scientifically feasible to store large quantities of CO<sub>2</sub> in saline aquifers. In order to address outstanding technical issues that need to be resolved to confirm CCS as a major mitigation option, and to establish public confidence that large scale sequestration is practical and safe, it is urgent to undertake a number of large scale (on the order of 1 million tonnes/year injection) experimental projects in reservoirs that are instrumented, monitored, and analyzed to verify the practical reliability and implementation of sequestration. None of the current sequestration projects worldwide meets all of these criteria.

*Recommendation #2:* The United States should undertake three to five sequestration projects — at a scale of about 1 million tonnes/year injection — in order to answer the outstanding technical questions concerning CO<sub>2</sub> sequestration.

The technical requirements for these sequestration projects are set forth in Chapter 4, as well as the estimated cost of about \$15 million per year for each project, not including the cost of the significant supply of CO<sub>2</sub> to be injected. Below, we discuss potential sources of the CO<sub>2</sub>.

The introduction of CO<sub>2</sub> capture and sequestration on a significant scale will require the construction and operation of a large infrastructure of pipelines, surface injection facilities and a monitoring and analysis network. As discussed in Chapter 4, further work is needed to determine the location and capacity of sites suitable for CO<sub>2</sub> storage in relation

to coal conversion plants and existing coal resources, and to develop the institutional arrangements that will govern CO<sub>2</sub> storage sites over very long time periods. Therefore we recommend:

*Recommendation #3:* The DOE in cooperation with the USGS should undertake a bottom-up review of possible sequestration sites in relation to major coal burning facilities. The United States government should encourage surveys in other parts of the world, specifically in India and China, where large and growing use of coal is anticipated.

As mentioned in Chapter 4, the federal government's authority to regulate CO<sub>2</sub> injection rests with the U.S. Environmental Protection Agency (EPA)'s *Underground Injection Control* program. The purpose of this program is to protect drinking water. This authority does not provide a broad enough regulatory framework for CO<sub>2</sub> injection and storage.

Moreover, CO<sub>2</sub> storage is intended to be permanent. There is a possibility of leakage (especially from an injection failure) into ground water or, more improbably, a catastrophic leak that potentially might injure people, as noted in Chapter 4. Commercial firms do not have the longevity or capacity to warrant the integrity of the storage system for the required periods of time. Therefore an insurance system is needed (ultimately backed by a government guarantee) that covers liability after some period of time and for catastrophic events. The terms and structure of this liability are important parts of the needed regulatory framework. In particular, mechanisms must be put in place to ensure that those responsible for sequestration sites ensure that these sites are operated, maintained and monitored to the highest standards of safety and economic efficiency, despite the availability of social insurance and the potential "moral hazard" problems that might arise.

As discussed in Chapter 4, the regulatory framework must include criteria for site selec-

tion, procedures for injection, requirements for interim monitoring, and transfer of liability to the U.S. government after some period of operation. Moreover, the regulatory regimes of different nations must be consistent. This is a broad range of requirements that involve the interests of several agencies including the EPA, DOE, the Department of Interior and, importantly, the Department of State. We recommend:

*Recommendation #4:* An element of the Executive Office of the President (the President might designate lead responsibility to the National Economic Council, the Office of Management and Budget, or the Office of Science and Technology Policy), should initiate an interagency process to determine the regulatory framework—including certification and closure of sites and the appropriate transfer of liability to the government—needed for a safe CO<sub>2</sub> transportation and storage system. Enforcement and inspection supporting the regulations should be the responsibility of the EPA.

## COAL CONVERSION TECHNOLOGIES

Chapter 3 presents our analysis of alternative approaches to coal conversion with CCS. This analysis leads us to conclude:

*Finding #6:* It is premature to select one coal conversion technology as the preferred route for cost-effective electricity generation combined with CCS. With present technologies and higher quality coals, the cost of electricity generated with CCS is cheaper for IGCC than for air or oxygen-driven SCPC. For sub bituminous coals and lignite, the cost difference is significantly less and could even be reversed by future technical advances. Since commercialization of clean coal technology requires advances in R&D as well as technology demonstration, other conversion/combustion technologies should not be ruled out today and deserve R&D support at the process development unit (PDU) scale.

The 2005 Energy Act contains significant incentives for demonstrating “clean coal” technologies and gives significant latitude to the Secretary of Energy to determine which technologies should receive benefits. The 2005 Energy Policy Act gives DOE authority to extend significant benefits to IGCC plants and to pulverized coal plants with advanced technology *without* capture. The Act extends greater benefits to gasification technology for a number of reasons:

Advocates believe IGCC plants to be more flexible for accommodating possible future environmental requirements on criteria pollutants or mercury control and because today IGCC plants are estimated to have a lower retrofit cost for CCS than pulverized coal plants or are easily made “capture ready.”

**The cost of control of criteria pollutants and of mercury.** We find that while the control of conventional pollutants by IGCC is easier, i.e., less costly, than with SCPC, the difference in control cost is not sufficient to reverse the overall cost advantage of SCPC in the absence of a carbon charge. More stringent controls on criteria pollutants and mercury may be adopted in the future, but we do not believe it possible to predict today the net cost impact of tighter controls on IGCC and SCPC, especially since each of these technologies continues to improve in terms of performance and cost.<sup>1</sup>

**Coal plants will not be cheap to retrofit for CO<sub>2</sub> capture.** Our analysis confirms that the cost to retrofit an air-driven SCPC plant for significant CO<sub>2</sub> capture, say 90%, will be greater than the cost to retrofit an IGCC plant. However, as stressed in Chapter 3, the modifications needed to retrofit an IGCC plant for appreciable CCS are extensive and not a matter of simply adding a single simple and inexpensive process step to an existing IGCC plant. CO<sub>2</sub> capture requires higher pressures, shift reactors, and turbines designed to operate with a gas stream that is predominantly hydrogen. Turbines that do this are yet to be deployed. In fact, the low heat rate incentives

in the 2005 Energy Act favor gasifier configurations that involve radiant heat recovery, or radiant and convective heat recovery. The gasifier configuration that would be used in the design of an IGCC system to be retrofitted for CO<sub>2</sub> capture is likely to be a straight quench gasifier, which would not meet the heat rate incentives in the Energy Act. Consequently, IGCC plants without CCS that receive assistance under the 2005 Energy Act will be more costly to retrofit and less likely to do so.

**The concept of a “capture ready” IGCC or pulverized coal plant is as yet unproven and unlikely to be fruitful.** The Energy Act envisions “capture ready” to apply to gasification technology.<sup>2</sup> Retrofitting IGCC plants, or for that matter pulverized coal plants, to incorporate CCS technology involves substantial additional investments and a significant penalty to the efficiency and net electricity output of the plant. As a result, we are unconvinced that such financial assistance to conventional IGCC plants without CCS is wise.

Currently four coal-fueled and five in-refinery coke/asphalt-fueled IGCC plants are operating around the world,<sup>3</sup> and many additional gasifier units are operating in the petrochemical industry. Each of the coal-fueled IGCC plants had a different and difficult start-up phase, but all are now operating with relatively high capacity factors. Despite the existence of these plants, IGCC advocates in the United States put forward a number of benefits as justification for federal assistance for IGCC plants designed without CCS.

Some suggest that the uncertainty about the imposition of a future carbon charge justifies offering federal support for a portion of the initial investment cost required to build new coal combustion plants without CCS today, so that if a carbon emission charge were imposed in the future, the CCS retrofit cost would be lower. We do not believe that sufficient engineering knowledge presently exists to define the relationship of the extent of pre-investment to the cost of future retrofit, and the design percentage of CO<sub>2</sub> removed. Moreover,

the uncertainty about when a carbon charge might be imposed makes it difficult (for either a private investor or the government) to determine the value of incurring a cost for a benefit that is realized, if at all, at some uncertain future time. Other than a few low-cost measures such as providing for extra space on the plant site and considering the potential for geologic CO<sub>2</sub> storage in site selection, the opportunity to reduce the uncertain eventual cost of CCS retrofit by making preparatory investment in a plant without CO<sub>2</sub> capture does not look promising. In sum, **engineering and policy uncertainties are such that there is no meaningful basis to support an investment decision to add significant “capture ready” features to IGCC or pulverized coal plants, designed and optimized for operation without CO<sub>2</sub> capture.**

*Recommendation #6a:* Technology demonstration of IGCC or pulverized coal plants without the contemporaneous installation of CCS should have low priority for federal assistance if the justification for this assistance is to reduce uncertainty for “first movers” of new technology.

Because the emphasis the 2005 Energy Policy Act gives to gasification technologies, we discuss further in Appendix 8.A the issue of federal support for IGCC plants without carbon capture.

There is, however, a serious policy problem in that prospective investors in either SCPC or IGCC plants without CO<sub>2</sub> capture, may anticipate that potentially they will be “grandfathered” or “insured” from the costs of future carbon emission constraints by the grant of free CO<sub>2</sub> allowances to existing coal plants, including those built between today and the start of the cap-and-trade system. The possibility, indeed political likelihood of such grandfathering, means that there is a perverse incentive to build coal plants early—and almost certainly these will be SCPC plants—to gain the potential benefits of these future allowances while also enjoying the higher electricity prices that will prevail in a future control regime. The net

effect is that early coal plant projects realize a windfall from carbon regulation and thus investment in these projects will raise the cost of future CO<sub>2</sub> control.

*Recommendation #6b:* Congress should act to close this potential “grandfathering” loophole before it becomes a problem for new power plants of all types that are being planned for construction.

**In contrast to the arguments for federal assistance to IGCC without CCS, there is justification for government assistance to “first mover” IGCC plants with CO<sub>2</sub> capture.** First, there is no operating coal plant that captures CO<sub>2</sub> at pressures suitable for pipeline transport, integrated with transfer and injection into a storage site. Second, as we have emphasized in Chapter 3 and above, there are major differences between an IGCC plant designed for CO<sub>2</sub> capture and an IGCC plant designed without CO<sub>2</sub> capture. Third, experience is needed in operating the IGCC plant and capture system under practical conditions of cycling plant operations and for a range of coals. Thus, there is a need for demonstration of an IGCC plant with CO<sub>2</sub> capture. As pointed out in Chapter 3, there are other technology choices that should also be considered for demonstrating CO<sub>2</sub> capture: (1) Oxy-fired SCPC or retrofit of a SCPC plant and (2) a coal to liquids plant. [We point out below why these technologies might be especially attractive demonstrations].

This suggests that the government provide assistance for projects that capture, transport, and sequester. The objective of such “first-of-a-kind” projects is to demonstrate (1) technical performance, (2) cost, and (3) compliance with environmental and safety regulations.

*Recommendation #7:* The federal government should provide assistance for 3 to 5 “first-of-a-kind” coal utilization demonstration plants with carbon capture. The scale of these should be on the order of 250 to 500 MWe power plants, or the product equivalent.

As discussed in Chapter 6, federal assistance for demonstration plants should be structured in a manner that interferes as little as possible with conventional commercial practice. One mechanism is for the government to purchase the pressurized, pipeline-ready CO<sub>2</sub> produced by the plant at a price needed to make carbon capture a viable private investment. Each technology choice will require a different level of assistance in terms of \$/ton CO<sub>2</sub> and therefore a tailored purchase arrangement is required for each technology. An open bidding process for the rights to government CO<sub>2</sub> purchase obligation is the best selection procedure, once the portfolio of desirable technologies is chosen. An estimate of the annual cost to the government to pay for capture at an IGCC facility is in the range of \$90 million/year<sup>4</sup> for a minimum of ten years.

The advantage of this approach is that the government pays only if the plant operates and the CO<sub>2</sub> it produces is captured, delivered to the site, and sequestered. The arrangement offers an incentive to have the plant function for the purpose of demonstrating carbon capture. In addition, the purchased CO<sub>2</sub> can act as the source of the CO<sub>2</sub> for sequestration demonstration facilities (see *Recommendation #2*).

*Recommendation #8:* The federal government, in the absence of any emission charge<sup>5</sup> should arrange to pay for CO<sub>2</sub>, produced at a coal facility at a price that will make it attractive for private concerns to build and operate a coal conversion plant with carbon capture.

Some question whether a federal government commitment to “take or pay” for CO<sub>2</sub> produced at a CCS plant will be viewed by private investors and lenders as reliable. Experience indicates that once the U.S. government has signed a long-term contract, for example for purchase or supply of electricity, the terms of the contract are honored. Investors would however face other uncertainties, for example, an unexpected drop in competing natural gas prices or improper technical performance of the plant. The CO<sub>2</sub> price could be set to compensate for some

of these uncertainties, although the principle of maintaining commercial practice means that not all risks should be taken out of the project.

## INTEGRATING CARBON CAPTURE, TRANSPORTATION, AND STORAGE

Chapter 3 of this report is devoted to coal combustion and conversion technologies and to CO<sub>2</sub> capture, and Chapter 4 is devoted to CO<sub>2</sub> storage. However, successful CCS requires integration of these two activities and the transportation of CO<sub>2</sub> produced at the coal plant to the injection point at the reservoir site. There is a major challenge of achieving an integrated system from combustion to storage. A successful project needs to demonstrate the technical aspects of capture and sequestration but also the regulatory arrangements needed to site a CO<sub>2</sub> pipeline, injection practices, and storage site selection. **Accordingly, the appropriate objective is to demonstrate the system level integration of carbon capture with CO<sub>2</sub> storage.**

It is important to appreciate the complexity of this integration. The plant produces pressurized, transport-ready CO<sub>2</sub> at a rate determined by the operating tempo of the plant. In the case of IGCC, this occurs within a performance envelope constrained by the integration of the gasification process with turbine operation that is determined by the electricity dispatch on the regional grid. A pipeline or pipeline network is required to transport the liquid CO<sub>2</sub> at the rate of CO<sub>2</sub> production to an injection point at the reservoir, ideally not too distant, and accommodate any variation in the operating cycle of the producing plant. The reservoir injection system must have the capacity to inject the arriving gas at variable rates. Successful operation requires a sophisticated control system and as yet undemonstrated engineering integration.

**In sum, the demonstration of an integrated coal conversion, CO<sub>2</sub> capture, and sequestration capability is an enormous system engineering and integration challenge.** Difficult

technical design and economic issues must be solved, a functioning regulatory framework needs to be established, and a sensible and politically acceptable federal assistance package must be worked out. All of this needs to be done while maintaining sufficient fidelity to commercial practice, so that both the government and the private sector can gain credible information on which to base future public and private investment decisions.

Successful execution of the demonstration program we recommend requires successful timing of five elements:

- Providing a supply of about one million tonnes/y CO<sub>2</sub> for the 3 to 5 sequestration projects.
- Utilizing the CO<sub>2</sub> produced by the coal conversion projects.
- Providing pipeline transport facilities between the coal conversion projects and the sequestration sites.<sup>6</sup>
- Injection and sequestration
- Detailed reservoir characterization and monitoring

This is an enormous and complex task and it is not helpful to assume that it can be done quickly or on a fixed schedule, if for no other reasons than the need for required regulatory, financing, and siting actions. In addition, a selection needs to be made about the coal conversion technologies for the CO<sub>2</sub> capture demonstrations. (IGCC, SCPC, Oxy-fuel combustion, coal to synfuels). It may be that timing considerations lead to a sequence that is less than optimal — for example, a supply of CO<sub>2</sub> for an early sequestration project may come from a relatively expensive capture option, such as chemical amine capture of CO<sub>2</sub> from the flue gas of an air-driven SCPC or from a non-utility source.

An effective mechanism is needed to assure efficient and prompt execution of the recommended demonstration program. As discussed in Chapter 6, the DOE has limited capability to carry out such a task: its staff has little ex-

perience with commercial practice, it is hampered by federal procurement regulations, and it is constrained by an annual budget cycle. A quicker and more effective way to achieve the objective of demonstrating a credible option for CO<sub>2</sub> capture and sequestration is for the president to recommend to Congress a structure, authorities, and functions for a quasi-public CCS corporation.

*Recommendation #9:* The demonstration sequestration projects (*Recommendation #2*) and the demonstration carbon capture projects (*Recommendation #8*) must be designed and operated in a manner that demonstrate successful technical performance and cost, with acceptable environmental effects.

**While a rigorous CO<sub>2</sub> sequestration demonstration program is a vital underpinning to extended CCS deployment that we consider a necessary part of a comprehensive carbon emission control policy, we emphasize there is no reason to delay prompt consideration and adoption of a U.S. carbon emission control policy until completion of the sequestration program we recommend.**

We further recommend consideration of the creation of a quasi-public corporation for the purpose of managing this demonstration and integration effort. This special purpose corporation – *The Clean Coal Demonstration Corporation* – would be given multi-year authorization and appropriation to accomplish the limited demonstration program outlined above. A rough estimate for the cost of the entire program is about \$5 billion for a ten-year period. The cost of this proposed demonstration program could be met by direct federal appropriation or by a small charge, less than ½ mill per kWe-h, on coal fired electricity plants.

The first one or two demonstration CO<sub>2</sub> sequestration projects (*Recommendation #7* above) will require a great deal of technical work to define design and operating characteristics as well as needed reservoir sensors and monitor-

ing. Accordingly, the DOE will need to have a large role in these initial projects compared to the proposed *Clean Coal Demonstration Corporation*. The best way to realize progress for the initial sequestration projects may be to authorize the DOE to perform them directly, although close coordination with the *Clean Coal Demonstration Corporation* would be required. Alternatively, the *Clean Coal Demonstration Corporation* could contract with the DOE for the required technical assistance for the early sequestration projects.

## **ANALYSIS, RESEARCH, DEVELOPMENT, AND DEMONSTRATION (ARD&D) NEEDS**

Chapter 6 discusses the analysis, R&D, and demonstration needs for the future of coal.

We present a framework for the types of work that are needed and explore whether the federal government or the private sector should be expected to sponsor such work.

In general, the role of the federal government is to fund long-term technical activities not tied to a particular commercial application where the social benefits of the results of the funding support cannot be appropriated, or only partially so, by private investors (e.g., through patents and trade secrets), or where the social benefits are so valuable that it is in the public interest to disseminate the results of the R&D widely and inexpensively. Many of the uncertainties about CCS that can be resolved by the R&D activities that we propose have one or both of these characteristics. The private sector should be expected to sponsor work that is in its foreseeable economic interest and adds to the attractiveness of the technologies and products they know.

Our focus is on support from the federal government, mainly through the DOE whose program was examined in Chapter 6.

*Finding # 7:* The DOE Clean Coal ARD&D program is not on a path to address our priority recommendations because the

level of funding falls far short of what will be required in a world with significant carbon charges. The program is especially deficient in demonstrating the feasibility of CO<sub>2</sub> sequestration, as discussed in Chapter 4 and mentioned in *Finding #2*. The flagship DOE project, FutureGen, is consistent with our priority recommendation to initiate integrated demonstration projects at scale. However, we have some concerns about this particular project, specifically the need to clarify better the objectives (research vs. demonstration), the inclusion of international partners that may further muddle the objectives, and whether political realities will allow the FutureGen consortium the freedom to operate this project successfully. Finally, the DOE program should support a broader range of technology efforts at the process development unit (PDU) scale designed to explore new approaches that have technical and economic advantage.

The demonstration projects we recommend are discussed above. The Analysis and R&D efforts recommended for support as discussed in Chapter 6 are summarized in Table 8.1, along with an estimate of the required annual level of effort.

*Recommendation #10* There is an urgent need to develop modeling and simulation capability and tools based on validated engineering and cost data for the purpose of analysis and comparison of coal-based generation, with and without carbon capture and sequestration. Such a capability will multiply the benefits of the many ‘front end engineering studies’ (FEED) underway both here and abroad, permitting comparison of the consequences of the assumptions of the various studies and enabling trade-off analysis between them. This will be great value both for the government and for private firms in planning their development and investment decisions, both for new plants and for retrofits.

*These seven findings and ten recommendations provide the basis for our central message: The demonstration of technical, economic, and institutional features of carbon capture and sequestration, at commercial scale coal combustion and conversion plants, will: (1) give policymakers and the public greater confidence that a practical carbon emission control option exists, (2) shorten the deployment time and reduce the cost for carbon capture and sequestration should a carbon emission control policy be adopted, and (3) maintain opportunities for the lowest cost and most widely available energy form to be used to meet the world’s pressing energy needs in an environmentally acceptable manner.*

**Table 8.1 Analysis, Research, And Development Needs\***

	ACTIVITY TYPE				RESPONSIBILITY***		ACTIVITY DESCRIPTION	ACTIVITY DESCRIPTION		
	ANALYSIS	R&D	PDU	COMMER	U.S. GOV.***	INDUSTRY	NEXT 5 YEARS	5+ YEARS AND BEYOND		
			DEMO	DEMO**						
R E C O M M E N D A T I O N	<b>ANALYSIS AND SIMULATION</b>									
	1	X				P (\$50)	S	Develop modeling and simulation capability and tools based on validated engineering and cost data for the purpose of analysis and comparison of coal-based generation technologies, with and without carbon capture and sequestration	Apply and refine said tools	
	<b>PC TECHNOLOGY</b>									
	2	X	X	X		P (\$40)			Develop more cost effective and energy efficient CO <sub>2</sub> capture technology	Evaluate most promising systems at PDU scale to define parameter space & develop models
	3		X	X		S (\$10)	P	For USC above 675 C, develop the next level of new materials and fabrication technology	Demonstrate adequate creep rates and field performance at PDU scale	
	4			X	X	S (\$20)	P	Develop and demonstrate improved technology to capture and fix mercury		
	<b>OXY-FUEL</b>									
	5		X		X	P (\$5)			Define purity requirements of CO <sub>2</sub> stream for processing and pipelining, and for geologic sequestration as a function of the geology	Verify performance in the sequestration demonstrations
	6	X	X	X		P (\$10)	S	Develop and demonstrate novel, cheaper oxygen separation technologies		
	7	X			X	P (\$15)	S	Support analysis and design studies, and process development for oxy-fuel PC with CO <sub>2</sub> capture	Oxy-fuel demonstration project as a retrofit and as a CO <sub>2</sub> source	
	<b>IGCC</b>									
	8	X				S (\$20)	P	System/technology trade-off studies (See #1) for optimization of capture, retrofit, & capture-ready designs (for various coal types)		
	9		X			P (\$60)	P	Component development: Improved refractory, better coal introduction technology, and improved instrumentation for gasifier measurement and control		
	10		X	X	X	P (\$15)	P	Develop turbines to burn high concentrations of hydrogen	Test and improve emissions performance	
	11	X			X	P(\$15)	P	IGCC commercial demonstration with CO <sub>2</sub> capture, and as a CO <sub>2</sub> source	Continue IGCC Demo with CCS, \$ for R&D Support of Demo	
	<b>ADVANCED CONCEPTS</b>									
	12	X	X	X		P (\$50)	S	Chemical Looping, flue and syngas cleaning & separations, in-situ gasification, supercritical water and CO <sub>2</sub> coal combustion, and other novel concepts	PDU studies of technologies showing unique potential	
	13	X	X			P (\$10)		Hybrid IGCC + Fuel Cell power generation systems		
<b>POLYGENERATION: FUELS &amp; CHEMICALS****</b>										
14	X				P (\$15)	S	Poly-generation in combination with #1 design and engineering studies of chemical + electricity production			
15	X	X	X		P (\$25)	S	Coal to liquids, Coal to gas in combination with #1 design and engineering studies, including CCS			
<b>SEQUESTRATION</b>										
16	X				P (\$40)		Detailed, bottom-up geological assessment of storage capacity and injectivity			
17	X				P (\$20)		Risk analysis of potential geologic storage regions			
18	X	X			P (\$40)		Design and develop sensors and monitoring system for CO <sub>2</sub> storage site, carry out site surveys, determine engineering protocols for injection & MMV R&D during demos	Proceed with 3–4 large-scale sequestration demo projects of order 1 million tonnes CO <sub>2</sub> /y, \$ are R&D in support of them		

\* This study focused on power generation from coal and did not include coal preparation, mining, transportation, or other industrial uses; ocean or biomass sequestration in the Gtonne scale, or novel approaches to criteria pollutant control from power generation facilities.

\*\*Key commercial-scale demonstrations indicated but \$ indicated are only for supporting R&D

\*\*\* P = primary responsibility; S = secondary responsibility; dollar amount in parenthesis is estimated needed annual R&D expenditure in millions by DOE

\*\*\*\* Downstream technology for syngas conversion is not part of this report



## CITATIONS AND NOTES

1. Even if IGCC were more economical for meeting criteria pollutant and mercury emission constraints, this would not be a reason for federal support.
2. Conference report of the Energy Policy Act PL108-58 Sec48A(c)(5) CARBON CAPTURE CAPABILITY.—The term ‘carbon capture capability’ means a gasification plant design which is determined by the Secretary to reflect reasonable consideration for, and be capable of, accommodating the equipment likely to be necessary to capture carbon dioxide from the gaseous stream, for later use or sequestration, which would otherwise be emitted in the flue gas from a project which uses a nonrenewable fuel.
3. The table below gives the size and location of operating IGCC power plants.
4. For example, an efficient 500 MW<sub>e</sub> IGCC power plant would produce about 3 million tons/y CO<sub>2</sub> and the differential cost might be about \$30/ton CO<sub>2</sub>.
5. If a carbon charge is imposed, the price paid by the government would be adjusted downward accordingly.
6. This will be less of a problem if the coal conversion plants are located near or at the sequestration sites.

### Operating IGCC power plants Fuel is either coal or coke/asphalt

SIZE MW <sub>e</sub>	LOCATION	PRIMARY FEED
298	Puertollano, Spain	coal
253	Buggenum, Netherlands	coal/some biomass
250	Tampa Electric, Florida	coal/coke
262	Wabash River, Indiana	coal/coke
551	Sarlux, Italy	refinery resid/tars
552	Priolo, Italy	refinery asphalt
342	Negishi, Japan	refinery resid/tars
250	Sannazzaro, Italy	refinery resid/tars
180	Delaware City, Delaware	coke



# Glossary of Technical Terms and Abbreviations

**ARD&D**

Analysis, Research, Development,  
and Demonstration

**ASU**

Air Separation Unit

**BACT**

Best Available Control Technology

**BAU**

Business As Usual

**CAIR**

Clean Air Interstate Rule

**CAMR**

Clean Air Mercury Rule

**CCS**

Carbon Capture and Storage

**CFB**

Circulating Fluid Bed

**CGE**

Computable General Equilibrium

**COE**

Cost of Electricity,  $\text{¢/kW}_e\text{-h}$

**CSLF**

Carbon Sequestration Leadership Forum

**EOR**

Enhanced Oil Recovery

**EPPA**

Emissions Prediction and Policy Analysis Model  
(MIT)

**EPRI**

Electric Power Research Institute

**ESP**

Electrostatic Precipitator or Precipitation

**FGD**

Flue Gas Desulfurization

**F-T**

Fischer-Tropsch

**GHG**

Greenhouse Gas

**HHV**

Higher Heating Value, kJ/kg

**HRSG**

Heat Recovery Steam Generator

**ICE**

Injectivity, Capacity and Effectiveness

**IECM**

Integrated Environmental Control Model  
(Carnegie Mellon University)

**IGCC**

Integrated Gasification Combined Cycle

**LAER**

Lowest Achievable Emissions Rate

**LLV**

Lower Heating Value, kJ/kg

**LNG**

Liquified Natural Gas

**LPG**

Liquified Petroleum Gas

**MDEA**

Methyl-Diethanol Amine

**MEA**

Mono Ethanol Amine

**MMV**

Measurement, Monitoring, and Verification

**NAAQS**

National Ambient Air Quality Standards

**NG**

Natural Gas

**NGCC**

Natural Gas Combined Cycle

**NPV**

Net Present Value

**O&M**

Operating and Maintenance Costs, ¢/kW<sub>e</sub>-h

**PC**

Pulverized Coal

**PDF**

Probability-Density Function

**PDU**

Process Demonstration Unit

**PM**

Particulate Matter

**PRB**

Powder River Basin

**RD&D**

Research, Development, and Demonstration

**SC**

Supercritical

**SCPC**

Supercritical Pulverized Coal

**SCR**

Selective Catalytic Reduction

**SFC**

Synthetic Fuel Corporation

**SIP**

State Implementation Plan

**SNCR**

Selective Non-Catalytic Reduction

**SNG**

Synthetic Natural Gas

**SUBC**

Subcritical

**TCR**

Total Capital Required, \$/kW<sub>e</sub>

**TPC**

Total Plant Cost, \$/kW<sub>e</sub>

**UIC**

Underground Injection Control

**USC**

Ultra-Supercritical

**USGS**

US Geological Survey

# Chapter 3 Appendices

## Appendix 3.A — Coal Quality

Coal type and quality can have a major impact on power plant heat rate, capital cost, generating efficiency, and emissions performance, as well as on the cost of electricity (COE). The carbon, moisture, ash, sulfur and energy contents, and the ash characteristics are all important in determining the value of the coal, its use in power generation, the choice of the technology employed, and its transportation and geographical extent of use.

**Coal Reserves and Usage** The estimated total recoverable coal reserves in the world are a little over 900 billion tonnes (long or metric tons), sufficient to meet current demand for almost 200 years [1]. The U.S. has about 255 billion tonnes of recoverable coal reserves or about 27% of the world total, more than any other country (See Figure 2.1, Chapter 2) [2]. Our coal reserves consist of about 48% anthracite and bituminous coal, about 37% subbituminous coal, and about 15% lignite. The distribution of coal reserves in the U.S. is shown in Figure A-3.A.1 [3]. Table A-3.A.1 gives the U.S. coal production by coal region for 2004.

**Figure A-3.A.1** Distribution of Coal Reserves by Type in the U.S.

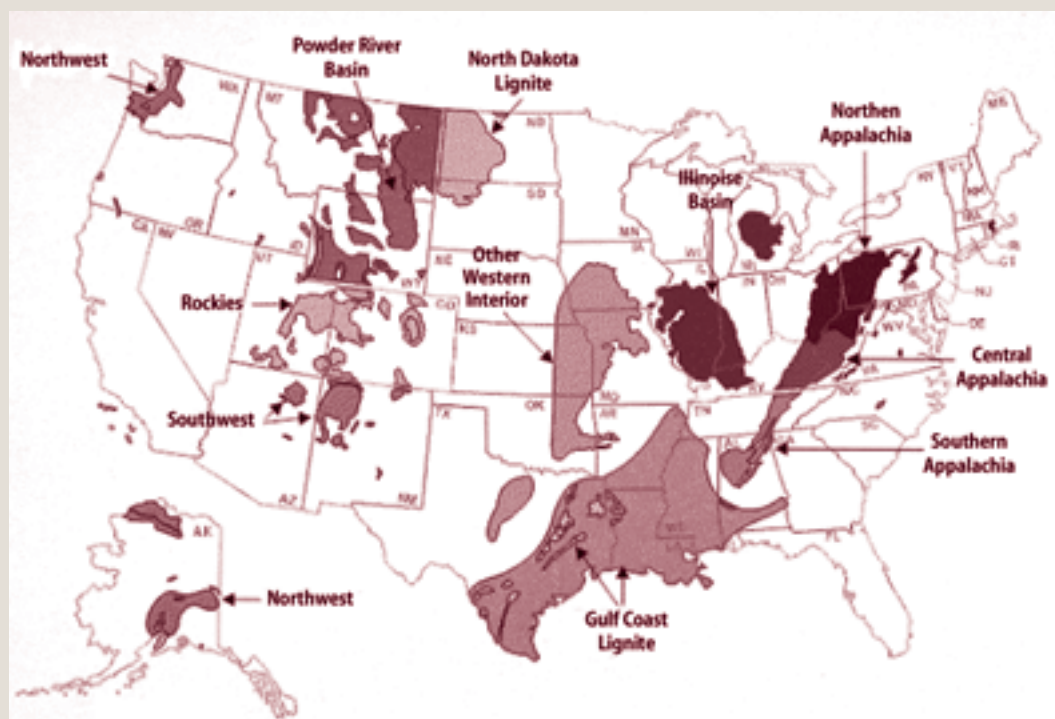

**Table A-3.A.1 U.S. 2004 Coal Production by Coal Region**

REGION	NORTHWEST	SOUTHWEST	ROCKIES	POWER RIVER BASIN (PRB)	N.DAKODA LIGNITE	OTHER WESTERN INTERIOR	GULF COAST LIGNITE	ILLINOIS BASIN (ILLIN #6)	NORTHERN APPALACHIAN (PITTS #8)	SOUTHERN APPALACHIAN	CENTRAL APPALACHIAN
2004 Coal Production, thousand tonnes	6.6	36.3	56	397	27.2	2.2	48.5	82	121.2	22.9	200

In 2004, total global coal consumption was over 5,400 million tonnes [2]. Of this, ~1,500 million tonnes (28%) were used by China, 985 million tonnes (18%) by the U.S., and 446 million tonnes (8%) by India. Western Europe and the Eastern Europe/Former Soviet Union states used 652 and 670 million tonnes, respectively (12% each)[2]. Our Emissions Prediction and Policy Analysis (EPPA) model [4] projects 2030 world coal consumption at about 10,340 million tonnes, with 2,360 million tonnes (23%) being used in China, 1,550 million tonnes (15%) in the U.S., and 970 million tonnes (9.4%) in India.

**COAL TYPES AND CHARACTERISTICS** Figure A-3.A.2 provides a general overview of coal properties by type for the U.S., China, and India. Coal types range from anthracite, with a heating value (HHV) upwards of 30,000 kJ/kg (13,000 Btu/lb) to lignite with a heating value around 14,000 kJ/kg (6,000 Btu/lb). Heating value and mine-mouth cost typically vary directly with carbon content, whereas sulfur and ash content vary widely and depend primarily on site-specific geologic conditions. Moisture content normally increases from bituminous coal to lignite.

Coals that are typically used for electric power production in the U.S. include high- and medium-sulfur bituminous coals from the Appalachian regions and the Illinois Basin, and low-sulfur subbituminous coals and lignites from the Northern Plains, the Powder River Basin (PRB), and the Gulf Coast regions. Anthracite is generally used only for metallurgical applications. Chinese coals are typically bituminous varieties with relatively high ash content and varying sulfur content, and Indian coals are generally low-sulfur bituminous varieties with unusually high ash content.

**COMPONENT IMPACTS** Most of the energy content in coal is associated with the carbon present. Higher-carbon coals normally have high energy content, are more valued in the market place, and are more suited for PC and IGCC power generation.

Generating plants designed for high carbon content fuels have a higher generating efficiency and lower capital cost, and could be more effectively designed for CO<sub>2</sub> capture.

Sulfur, on the other hand, tends to decrease PC boiler efficiency, because of the need to maintain higher boiler outlet temperature to avoid condensation of sulfuric acid and resultant corrosion problems in downstream equipment. The higher outlet temperature carries thermal energy out of the boiler rather than converting it into steam to drive the steam turbine. High-sulfur content also increases FGD power requirements and operating costs. For IGCC, sulfur content impacts the size of the clean-up process but has little effect on cost or efficiency[5]. Sulfur's biggest impact to date has been to drive a shift from eastern high-sulfur coals to western low-sulfur subbituminous coals to avoid installing FGD units on operating PC plants or to minimize FGD operating costs on new plants. For CO<sub>2</sub> capture, high-sulfur coals may cause increased complications with the capture technologies.

**Figure A-3.A.2 Coal Characteristics by Coal Type**



Coal ash content and properties affect boiler design and operation. High-ash coals cause increased erosion and reduce efficiency, and may be more effectively handled in circulating fluid-bed boilers. Boilers are designed for the ash to exit the boiler either as a molten slag (wet bottom boilers), particularly for low fusion temperature ash, or as a fly ash (dry bottom boilers). Most boilers are dry ash designs. For IGCC plants, coal ash consumes heat energy to melt it, requires more water per unit carbon in the slurry, increases the size of the ASU, increases the cost per kW<sub>e</sub>, and reduces the overall generating efficiency. This has a larger effect with slurry-feed gasifiers, and as such, high-ash coals are more suited to dry-feed systems (Shell), fluid-bed gasifiers (BHEL), or moving-bed gasifiers (Lurgi)[5].

**Figure A-3.A.3 PC And IGCC Relative Heat Rate And Capital Cost**

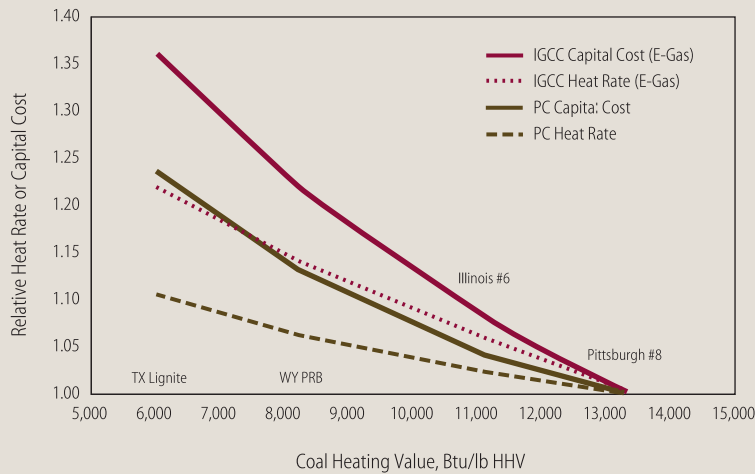

Adapted from National Coal Council[5], heat rate is 3414 Btu/kW<sub>e</sub>-h divided by plant generating efficiency.

**Figure A-3.A.4 Effect of Coal Quality on COE for Generation with and without CO<sub>2</sub> Capture**

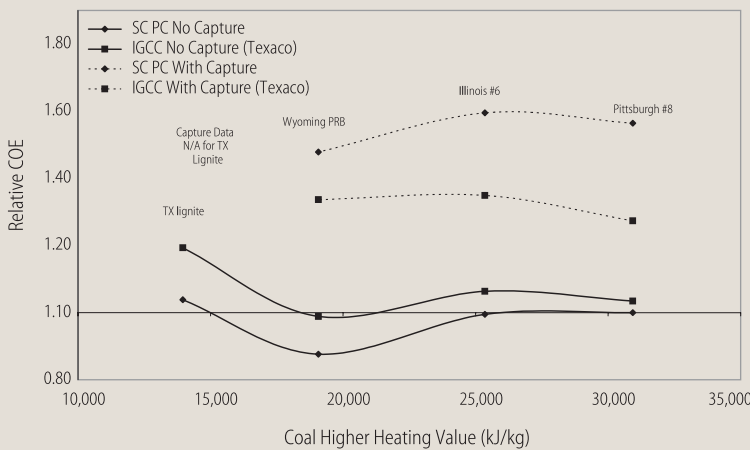

\*Based on minemouth coal cost (not including transportation costs).

Higher moisture content coals reduce generating efficiency in PC combustion plants and reduce gasifier efficiency in IGCC plants, increasing cost/kW<sub>e</sub> [6, 7]. CFB boiler size and cost also increases with higher moisture coals, but the effect is less pronounced than for PC systems. Slurry-fed gasifiers have the same problems with high-moisture coals as with high-ash coals. They both decrease the energy density of the slurry, increase the oxygen demand for evaporation of the excess moisture, increase cost per kW<sub>e</sub>, and decrease generating efficiency.

**IMPACT ON GENERATING EFFICIENCY, CAPITAL COST, AND COE**

Generating efficiency is affected by coal quality, as is capital cost. The high moisture and ash content of low-quality coals reduce generating efficiency, and increase capital cost. Figure A-3.A.3 shows how generating efficiency, expressed as heat rate [8], and capital cost change for both PC and slurry feed IGCC plants with coal quality [5]. Relative CO<sub>2</sub> emissions follow heat rate, and therefore the curve for relative heat rate in Figure A-3.A.3 also represents the relative CO<sub>2</sub> emissions per kW<sub>e</sub>-h.

However, the cost of electricity (COE) need not necessarily increase as coal quality decreases, as would be suggested by Figure A-3.A.3. This is because mine-mouth coal cost decreases with coal quality, and to a different extent than heat rate (generating efficiency) and capital cost increase. Actual COE will be highly dependent on coal cost and coal transportation cost, which can vary with coal type, time, and geographic location. Figure A-3.A.4 indicates how COE can vary with coal quality at average 2004 mine-mouth costs.

Although many assumptions are involved, these relative COE numbers show directionally the technology dependence of COE difference as a function of coal heating value. Figure A-3.A.5 shows the relative trend in the COE difference between IGCC and supercritical PC combustion as a function of coal type using 2004 mine mouth coal prices. Without CO<sub>2</sub> capture, the COE for SC PC is less than the COE for IGCC, and the gap widens for lower heating value coals. With CO<sub>2</sub> capture, the COE for IGCC is lower than that for SC PC, and the delta is therefore negative. However, the delta is projected to decrease with decreas-



ing coal heating value, as shown in Figure A-3.A.5. This is for a water-slurry feed gasifier, and estimates are based on limited data. A dry-feed gasifier should show better performance, although the impact on the cost deltas is unclear because of its higher cost. Figure A-3.A.5 suggests that an ultra-supercritical PC with a reduced-energy capture system could potentially be competitive with IGCC for low rank coals such as lignite.

## CITATIONS AND NOTES

1. EIA, *International Energy Outlook 2005*, E.I. Administration, Editor. 2005b, U.S. Department of Energy: Washington, D.C.
2. EIA. *International Energy Annual 2003*. EIA, International Energy Annual Review 2005 June, 2005 [cited 2005 December 2005]; Table 8.2]. Available from: [www.eia.doe.gov/iea/](http://www.eia.doe.gov/iea/).
3. EIA. *Coal Statistics Webpage*. 2005d [cited 2005 11/29/05]; Available from: <http://www.eia.doe.gov/fuelcoal.html>.
4. MIT-EPPA, *Emissions Prediction and Policy Analysis (EPPA) Model*, in *Joint Program on the Science and Policy of Global Change*. 2005, MIT: Cambridge, MA.
5. NCC, *Opportunities to Expedite the Construction of New Coal-Based Power Plants*. 2004, National Coal Council.
6. Holt, N., *Gasification and IGCC - Status, Challenges, Design Issues & Opportunities*, in *Reaction Engineering International*. 2005.
7. Holt, N., G. Booras, and D. Todd, *Summary of Recent IGCC Studies of CO2 Capture for Sequestration*, in *MIT Carbon Sequestration Forum IV*. 2003: Cambridge, MA.
8. Heat rate is the thermal energy input to the generating plant per kWe-h of net electricity generated. Heat rate is 3414 Btu/kWe-h divided by the efficiency.

**Figure A-3.A.5 Projected Relative COE Performance (IGCC Vs. SC PC) as a Function of Coal Rank Using 2004 Mine Mouth Coal Cost**

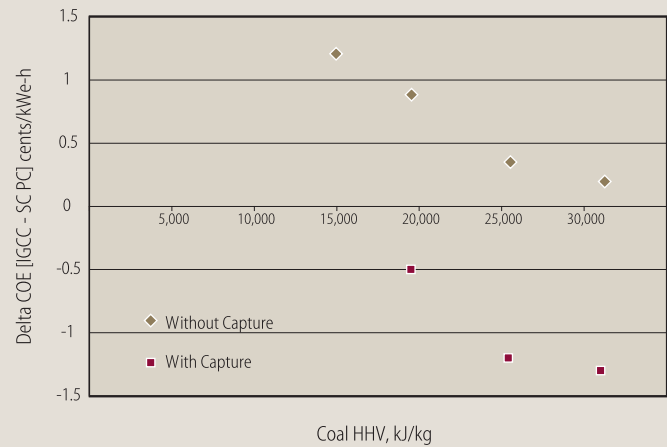

## Appendix 3.B — Electricity Generation Primer

### INTRODUCTION

This primer provides the next higher level of detail on coal-based electric power generation beyond that included in Chapter 3. To explore the subject further, we suggest the following references [1-4].

The electricity generating efficiency is the energy in the net electricity generated divided by the energy in the fuel used to generate that electricity on an all-in basis. Higher efficiency means less coal consumed and reduced emissions per unit of electricity. The chemical energy in the fuel can be expressed as either its Lower Heating Value (LHV) or its Higher Heating Value (HHV) [5]. In U. S. engineering practice, HHV is generally used for steam cycle plants; whereas in European practice, efficiency calculations are uniformly LHV based. The difference in efficiency between HHV and LHV for bituminous coal is about 2 percentage points absolute (5% relative), but for high-moisture subbituminous coals and lignites the difference is 3 to 4 percentage points. The efficiency of gas turbines is on an LHV basis in the U. S. and Europe. The thermal efficiency of an electricity generating plant may also be expressed as the “heat rate”, the fuel thermal energy consumption per unit of electricity produced, in kJ/kW<sub>e</sub>-h or Btu/kW<sub>e</sub>-h [6].

For the technology comparisons in this report, each of the generating technologies considered was a green-field unit, and each unit contained all the emissions control equipment required and was designed to achieve emissions levels somewhat lower than the current, best-demonstrated low criteria emissions performance. The design performance and operating parameters for these generating technologies was based on the Carnegie Mellon Integrated Environmental Control Model (IECM), version 5.0 [7] which is specific to coal-based power generation. The IECM model was used to achieve numbers with a consistent basis for comparison of the individual technologies. Other models would each give a somewhat different set operating parameters, such as overall generating efficiency, because of the myriad of design and parameter choices, and engineering approximations used. Thus, the numbers in this report will not exactly match other numbers found in the literature, because of these different design and operating bases and assumptions. Mature commercial technology, such as subcritical PC boiler and generator technology, was estimated based on current

performance. Commercial technologies that are undergoing significant evolution, such as more efficient emissions control and IGCC technologies, were estimated based on the n<sup>th</sup> plant, where n is a small number such as 5 or 6, in 2005 \$.

Coal type and properties are important in the design, operation, and performance of a power generating unit. The units all burn Illinois # 6 bituminous coal, a high-sulfur, Eastern U.S. coal with a moderately high heating value. Detailed analysis is given in Table A-3.B.1 [7].

**Table A-3.B.1 Analysis of Illinois #6 Bituminous Coal Used in the Design Base of Each of the Green-Field Generating Technologies**

		COMPONENT	% WT
ILLINOIS #6 BITUMINOUS COAL FUEL ANALYSIS — AS RECEIVED		Carbon	61.20
		Hydrogen	4.20
		Oxygen	6.02
		Chlorine	0.17
HIGH HEATING VALUE	<b>25,350 kJ/kg</b> (10,900 Btu/lb)	Sulfur	3.25
		Nitrogen	1.16
LOW HEATING VALUE	<b>24,433 kJ/kg</b> (10,506 Btu/lb)	Ash	11.00
		Moisture	13.00
		Mercury	1.04E-05

## AIR-BLOWN PULVERIZED COAL COMBUSTION

Figure A-3.B.1 shows an advanced, pulverized coal (PC) unit that meets today's low, permitted emissions levels [8]. The three main components of a PC unit are: (1) the boiler block where coal is burned to generate steam in the boiler tubes; (2) the generator block, which contains the steam turbine/electric generator set and manages the steam, condenser, and cooling water; and (3) the flue gas clean-up train, which removes particulates and criteria pollutants from the flue gas. The flue gas clean-up section contains Selective Catalytic Reduction (SCR) for  $\text{NO}_x$  removal, followed by electrostatic precipitation (ESP) to remove particulate matter, and wet flue gas desulfurization (FGD) to remove  $\text{SO}_x$ . The choice of coal, and the design and operation of the flue gas units is to assure that emissions are below the permitted levels.

**Figure A-3.B.1 Schematic of an Advanced, Low-Emissions, Pulverized Coal Unit**

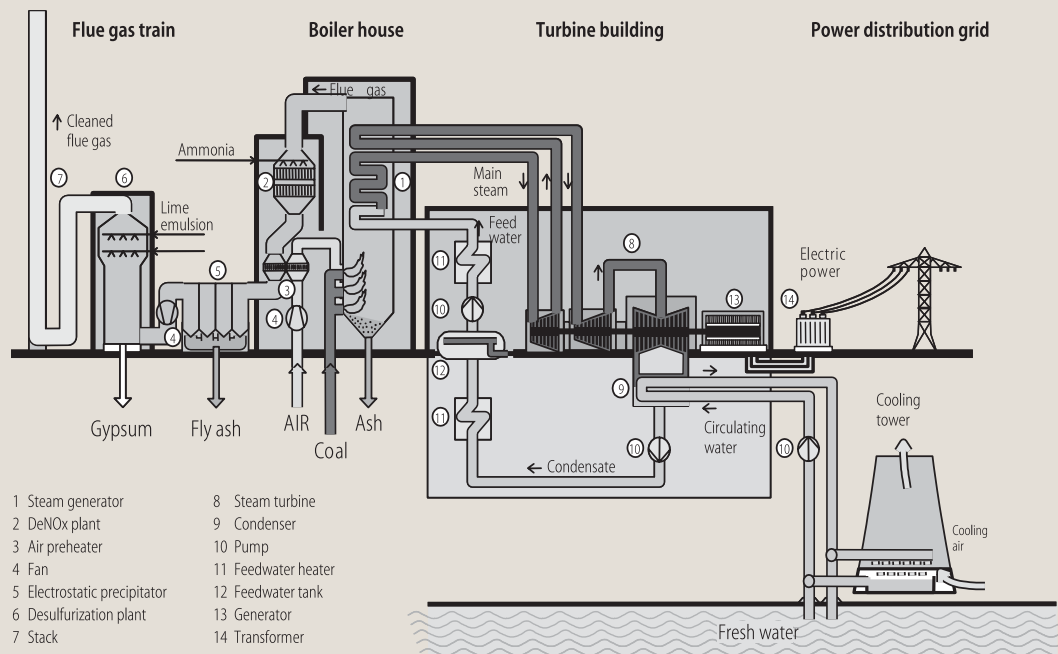

Courtesy ASME.

**PC GENERATION: WITHOUT  $\text{CO}_2$  CAPTURE** Figure A-3.B.2 is a detailed schematic of a subcritical PC unit with the important stream flows and conditions given [7, 9][10]. Air infiltrates into the boiler because it operates at below-atmospheric pressure so that hot, untreated combustion gases do not escape into the environment. Total particulate material removal is 99.9%, most of it being removed as fly ash by the electrostatic precipitator. Particulate emissions to the air are 11 kg/hr.  $\text{NO}_x$  emissions is reduced to 114 kg/hr by a combination of low- $\text{NO}_x$  combustion management and SCR. The flue gas desulfurization unit removes 99+% of the  $\text{SO}_2$  reducing  $\text{SO}_2$  emissions to 136 kg/hr. For Illinois #6 coal, the mercury removal with the fly ash and in the FGD unit should be 70-80% or higher. For these operating conditions, the IECM projects a generating efficiency of 34.3% for Illinois #6 coal. For Pittsburgh #8 (bituminous coal) at comparable  $\text{SO}_x$  and  $\text{NO}_x$  emissions, IECM projects a generating efficiency of 35.4% [7]. For Powder River Basin (subbituminous coal) and North Dakota Lignite at comparable emissions IECM projects generating efficiencies of 33.1% and 31.9% respectively.

**Figure A-3.B.2 Subcritical 500 MW<sub>e</sub> Pulverized Coal Unit without CO<sub>2</sub> Capture**

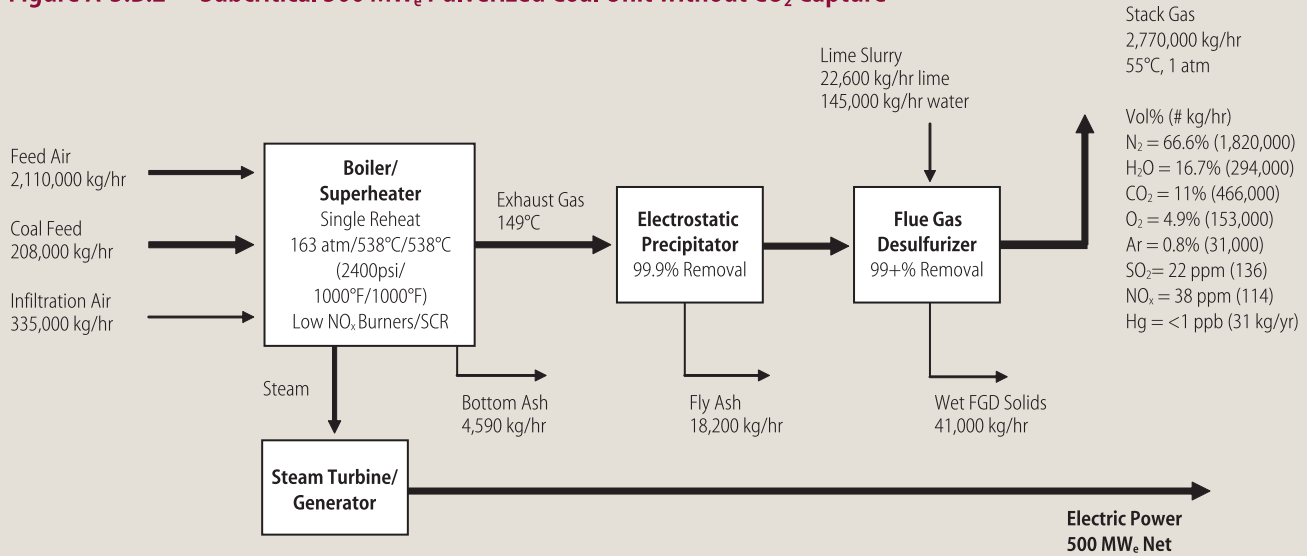

Booras and Holt [11], using an EPRI electricity generating unit design model, project 35.6% generating efficiency for Illinois #6 coal, at 95% sulfur removal and <0.1 lb NO<sub>x</sub>/million Btu. Under the same operating and emissions control conditions, they calculated a generating efficiency of 36.7% for Pittsburgh #8 coal, which is similar to the efficiency reported by the NCC study [12]. The difference between Illinois #6 and Pittsburgh #8 is due to coal quality and is the same for both models, about 1 percentage point. We attribute the IECM and EPRI model differences to the higher levels of SO<sub>x</sub> and NO<sub>x</sub> removal that we used and to differences in model parameter assumptions. For Illinois #6 coal, increasing SO<sub>x</sub> and NO<sub>x</sub> removal from the levels used by Booras and Holt to those used in this study reduces the generating efficiency by about 0.5 percentage point. The rest of the difference is almost certainly due to model parameter assumptions. For example, cooling water temperature, which has a large effect, could be one.

Figure A-3.B.3 is the schematic of an ultra-supercritical PC unit with the stream flows and operating conditions given. Flue gas emissions control efficiencies are the same. The main

**Figure A-3.B.3 Ultra-Supercritical 500 MW<sub>e</sub> Pulverized Coal Unit without CO<sub>2</sub> Capture**

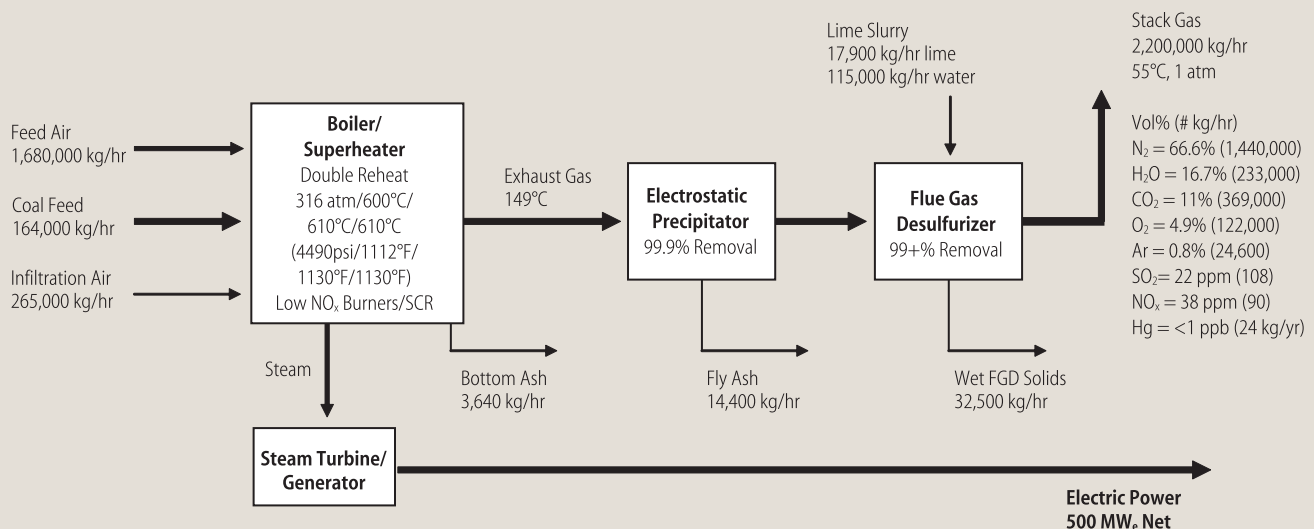

differences, compared to the subcritical PC unit, are: the generating efficiency, which is 43.3% vs. 34.3%; and the coal feed rate which is 21% lower, as is the CO<sub>2</sub> emissions rate. Other pollutant generation rates are lower also, but their emission rate is determined by the level of flue gas emissions control.

**CFB POWER GENERATION:** The most commonly used fluid-bed technology today is the circulating fluid bed combustor, of which one version is shown in Figure A-3.B.4. Coal and coal char are burned while the coal, coal char, coal ash, and sorbent are carried up through the furnace by combustion air. The solid materials are separated from the flue gas in the cyclone and pass through a convective section where heat is transferred to boiler tubes generating high-pressure steam. Additional steam is generated by removing heat from the hot solids in the fluid bed heat exchange section before they are returned to the furnace. There are no boiler tubes in the furnace because the rapidly moving solids cause excessive erosion. NO<sub>x</sub> is managed through low combustion temperature and staged injection of the combustion air. SO<sub>x</sub> emission is controlled via the lime sorbent in the bed. This saves significant capital for flue gas clean-up, but low SO<sub>x</sub> emissions require low-sulfur coal, and NO<sub>x</sub> emissions are limited by combustion chemistry. Extremely low emissions levels would require the addition of flue gas clean-up units with the attendant cost increase. The largest CFB unit is 320 MW<sub>e</sub> in Japan, and 600 MW<sub>e</sub> units have been designed, but no unit this size has been built. CFB units are best suited to low-value feedstocks such as high-ash coals or coal waste. They are very feed flexible and can also burn biomass. Figure A-3.B.5 shows the schematic for a CFB power generating unit burning lignite with the flows and operating conditions given.

**Figure A-3.B.4 Example Design Configuration of a Circulating Fluid-Bed Boiler**

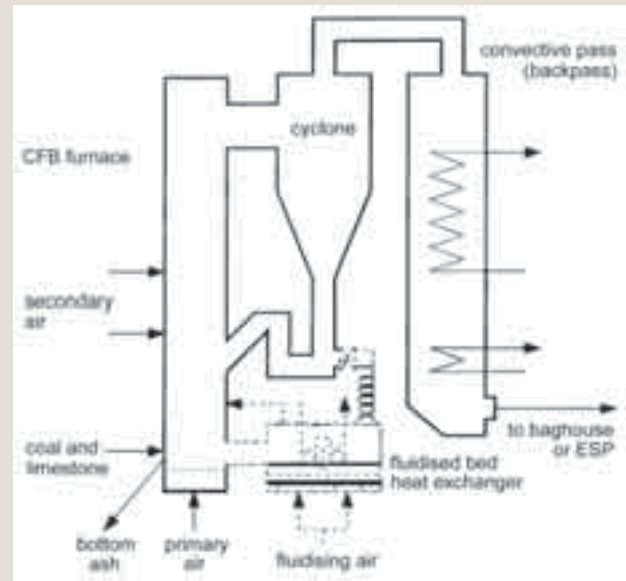

**Figure A-3.B.5 500 MW<sub>e</sub> Circulating Fluid-Bed Electricity Generating Unit Burning Lignite**

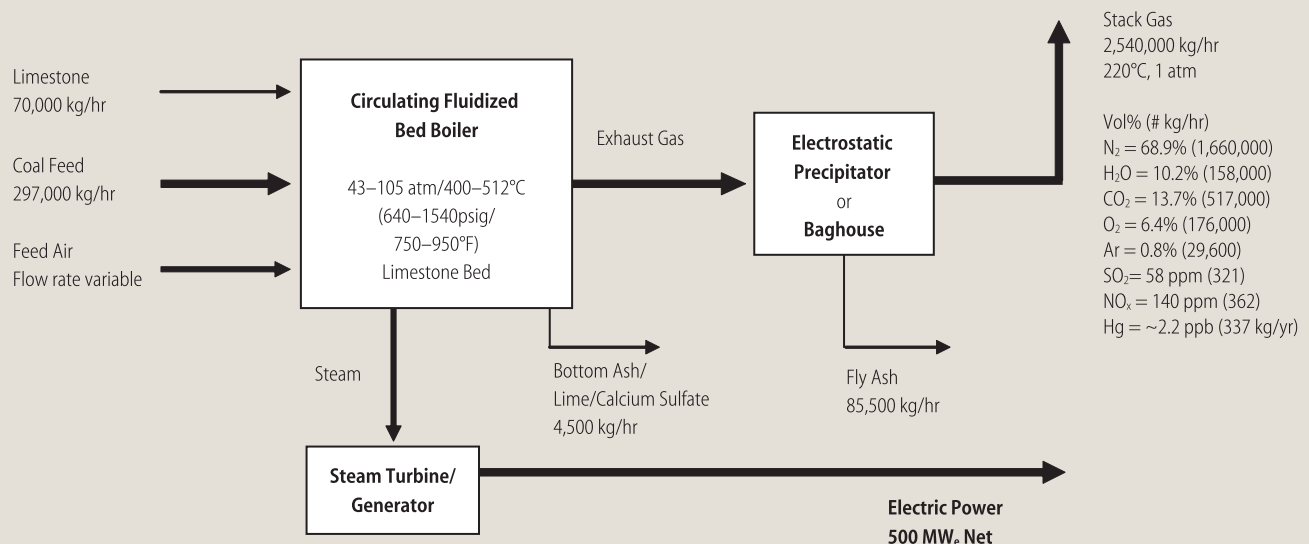

**Figure A-3.B.6 Subcritical Pulverized Coal Power Unit with CO<sub>2</sub> Capture**

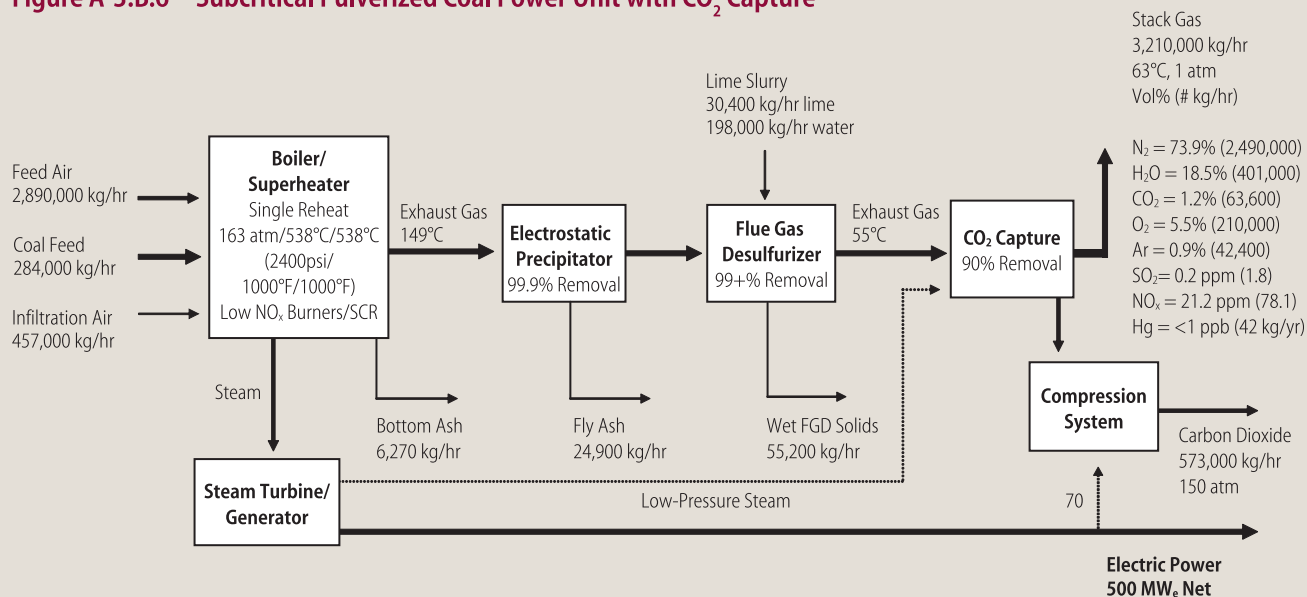

**PC GENERATION: WITH CO<sub>2</sub> CAPTURE** Figure A-3.B.6 is a detailed schematic of a subcritical PC unit with amine-based CO<sub>2</sub> capture to reduce CO<sub>2</sub> emissions by 90%. The internal power requirement for CO<sub>2</sub> capture and recovery is equivalent to almost 130 MW<sub>e</sub>, most of which is in the form of the low-pressure steam required to recover the absorbed CO<sub>2</sub> from the amine solution. Compression of the CO<sub>2</sub> consumes 70 MW<sub>e</sub>. This additional internal energy consumption requires 76,000 kg/hr additional coal, a 37% increase, over the no-capture case to produce the same net electricity. All associated equipment is also effectively 37% larger. Design and operating experience, and optimization could be expected to reduce this somewhat; as could new technology.

The process technology added for the capture and recovery of CO<sub>2</sub> effectively removes most of the SO<sub>2</sub> and PM that are not removed earlier in the flue-gas train so that their emissions are now extremely low, an added benefit of CO<sub>2</sub> capture.

Figure A-3.B.7 illustrates the effect of adding amine-based CO<sub>2</sub> capture to an ultra-supercritical unit. For 90% CO<sub>2</sub> capture, the internal energy consumption for capture and compression per unit of coal feed (or CO<sub>2</sub> captured) is the same for all the PC combustion technologies. However, for increasing technology efficiency, the coal consumption per net kW<sub>e</sub>-h produced, decreases leading to a reduced impact of CO<sub>2</sub> capture on the overall energy balance for the system. For ultra-supercritical PC, the efficiency reduction for CO<sub>2</sub> capture is 21% vs. 27% for subcritical PC.

### OXYGEN-BLOWN POWER GENERATION

The major cost associated with CO<sub>2</sub> capture from air-blown PC combustion is the low CO<sub>2</sub> concentration in the flue gas due to nitrogen dilution. Oxygen-blown combustion can avoid this and allow the direct compression of the flue gas which is then primarily composed of CO<sub>2</sub> and water. This should reduce the cost associated with the capture of CO<sub>2</sub> in coal combustion based power generation.

**Figure A-3.B.7 Ultra-Supercritical Pulverized Coal Unit with CO<sub>2</sub> Capture**

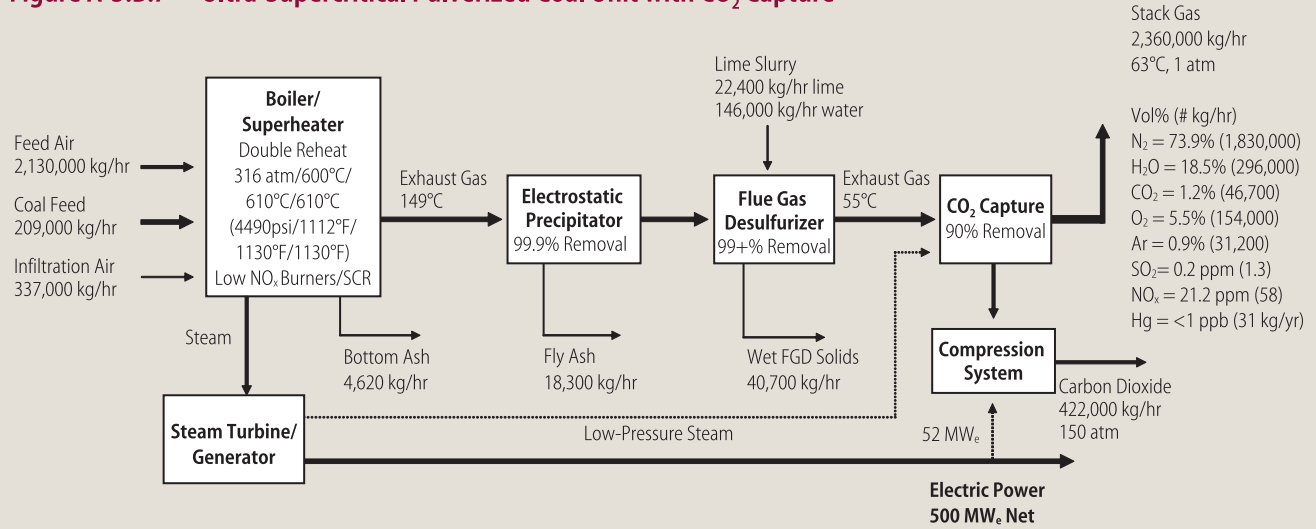
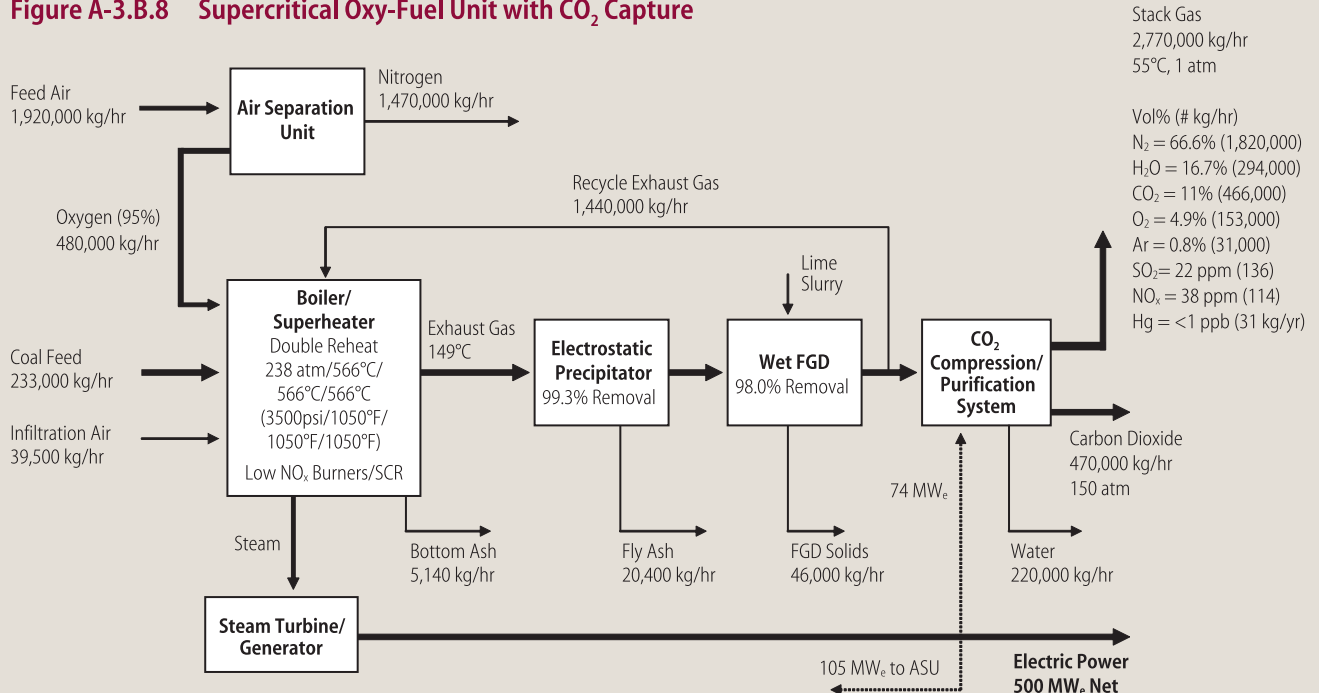

Figure A-3.B.8 gives a detailed schematic for a 500 MWe Supercritical Oxy-Fuel Power unit. In this design version of oxy-fuel PC, the flue gas is cleaned to achieve a high purity CO<sub>2</sub> stream after compression. The stack gas is decreased by almost 95% and criteria pollutant emissions would readily meet today's low permit levels. ASU and the CO<sub>2</sub> compression-purification consume about 180 MWe of internal power, which is what drives the increased coal feed rate. The separate wet FGD step may be eliminated for low-sulfur coal and/or with upgraded metallurgy in the boiler and combustion gas handling system. Further, with a newly designed unit it may be possible to eliminate the recycle entirely. These changes could reduce capital and operating costs significantly. If the CO<sub>2</sub> stream does not need to be high purity for sequestration, it may be possible to reduce the degree of CO<sub>2</sub> clean-up and the attendant cost. If air infiltration is sufficiently low, it may even be possible to eliminate the stack gas stream. These issues need further design clarification and experimental PDU verification since they represent potentially significant cost reductions.

**Figure A-3.B.8 Supercritical Oxy-Fuel Unit with CO<sub>2</sub> Capture**



## INTEGRATED COAL GASIFICATION COMBINED CYCLE (IGCC) TECHNOLOGY

**GASIFIER TYPES** A number of gasifier technologies have been developed. They are classified and summarized in Table A-3.B.2. Operating temperature for different gasifiers is largely dictated by the ash properties of the coal. Depending on the gasifier, it is desirable either to remove the ash dry at lower temperatures (non-slugging gasifiers) or as a low-viscosity liquid at high temperatures (slugging gasifiers). For all gasifiers it is essential to avoid soft ash particles, which stick together and stick to process equipment, terminating operation.

**Table A-3.B.2 Characteristics of Different Gasifier Types (adapted from [3])**

	MOVING BED	FLUID BED	ENTRAINED FLOW
Outlet temperature	Low (425–600 °C)	Moderate (900–1050 °C)	High (1250–1600 °C)
Oxidant demand	Low	Moderate	High
Ash conditions	Dry ash or slugging	Dry ash or agglomerating	Slugging
Size of coal feed	6–50 mm	6–10 mm	< 100 μm
Acceptability of fines	Limited	Good	Unlimited
Other characteristics	Methane, tars and oils present in syngas	Low carbon conversion	Pure syngas, high carbon conversion

The four major commercial gasification technologies are (in order of decreasing installed capacity):

1. Sasol-Lurgi: dry ash, moving bed (developed by Lurgi, improved by Sasol)
2. GE: slugging, entrained flow, slurry feed, single stage (developed by Texaco)
3. Shell: slugging, entrained flow, dry feed, single stage
4. ConocoPhillips E-Gas: slugging, entrained flow, slurry feed, two-stage (developed by Dow Chemical)

The Sasol-Lurgi gasifier has extensive commercial experience at Sasol's synfuel plants in South-Africa. It is a moving-bed, non-slugging gasifier. The other three are entrained-flow, slugging gasifiers. The GE/Texaco and Shell gasifiers have significant commercial experience, whereas ConocoPhillips E-Gas technology has less commercial experience. Proposed IGCC projects are focusing on entrained-flow, slugging gasifiers. These gasifiers are all oxygen blown. A 250 MW<sub>e</sub> air-blown IGCC demonstration plant is under construction for a 2007 start-up in Japan [13]. The gasifier is a two-stage, entrained-flow, dry-feed, medium-pressure, air-blown design.

Fluid-bed gasifiers are less developed than the two other gasifier types. Operating flexibility is more limited because they are typically performing several functions (e.g. fluidization, gasification, sulfur removal by limestone) at the same time [3]. The Southern Company is developing in Orlando, with DOE support, a 285 MW<sub>e</sub> IGCC project which is based on the air-blown, KBR transport reactor [14, 15]. This fluid-bed gasifier has been developed at smaller scale and is potentially suited for low-rank coals with high moisture and ash contents [16].

**GASIFIER DESIGN CONSIDERATIONS FOR IGCC** Integration of gasification into the total IGCC plant imposes additional considerations on the technology [17]. Moving-bed gasification technology cannot deal with a significant fraction of coal fines, which means that 20–30%



**Figure A-3.B.9 GE Full-Quench Gasifier Incorporated into an IGCC Unit**

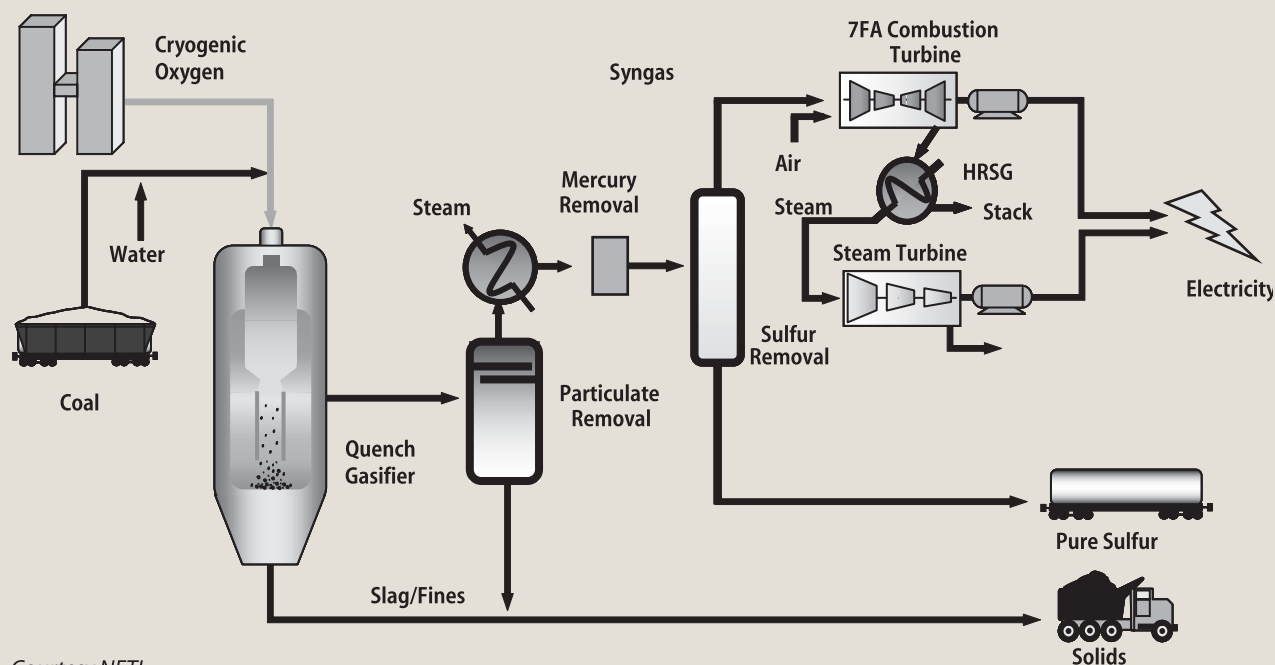

Courtesy NETL

of the processed coal cannot be fed to it. It also produces significant amounts of tars, etc. which cause downstream fouling problems. High-temperature, entrained-flow gasifiers do not have these issues and are thus more readily integrated into an IGCC system. High-pressure operation is favored for these units. The introduction of coal into a pressurized gasifier can be done either as dry coal feed through lock hoppers, or by slurring the finely ground coal with water and spraying it into the gasifier. The latter introduces about 30 wt% liquid water, which is desirable for the gasification reactions if the coal has low moisture content. However, for high-moisture coals the gasifier feed can approach 50% water which increases the oxygen required to gasify the coal and vaporize the water, and reduces the operating efficiency. For high-moisture coals, a dry-feed gasifier is more desirable [18]. High-ash coals have somewhat the same issues as high-moisture coals, in that heating and melting the ash consumes considerable energy, decreasing the overall operating efficiency.

The gas temperature leaving entrained flow gasifiers is about 1500 °C and must be cooled for the gas clean-up operations. This can be accomplished downstream of the gasifier by direct quench with water as in the GE full-quench configuration shown in Figure A-3.B.9. This configuration has the lowest capital cost and the lowest efficiency [17, 19, 20].

The GE-type gasifier is lined with firebrick and does not accommodate heat removal. However, a radiant syngas cooler can be added to recover heat as high-pressure steam, as shown in Figure A-3.B.10, which is used to generate electricity in the steam turbine. In the Shell gasifier, gasification and radiant heat removal are integrated into a single vessel. The membrane wall of the Shell gasifier, which becomes coated with a stable slag layer, recovers radiant heat energy via water filled boiler tubes. With the E-Gas gasifier, high-pressure steam is generated via radiant cooling in the second stage of the gasifier. This radiant heat recovery typically raises the overall generating efficiency by 3 percentage points [17]. Additional energy can be recovered, producing steam, by addition of convective syngas coolers, as also

shown in Figure A-3.B.10. This raises the overall efficiency by another 1 to 1.5 percentage points. These efficiency improvements require additional capital, but the added capital charge is essentially offset by decreased fuel cost.

Pressure is another factor in gasifier design. The simplest vessel shape and design along with slurry feed allow operation at higher pressures. Thus, the GE/Texaco gasifier can operate to 6.9 MPa (1000 psi); whereas E-Gas, because of vessel constraints, and Shell, because of dry-feed addition, are limited to about 3.3 to 4.1 MPa (500 to 600 psi). Pressure becomes more important when IGCC with CO<sub>2</sub> capture is considered [21].

**Figure A-3.B.10 Gasifier Heat Recovery Options: Radiant Syngas Cooler And Convective Syngas Coolers Illustrated**

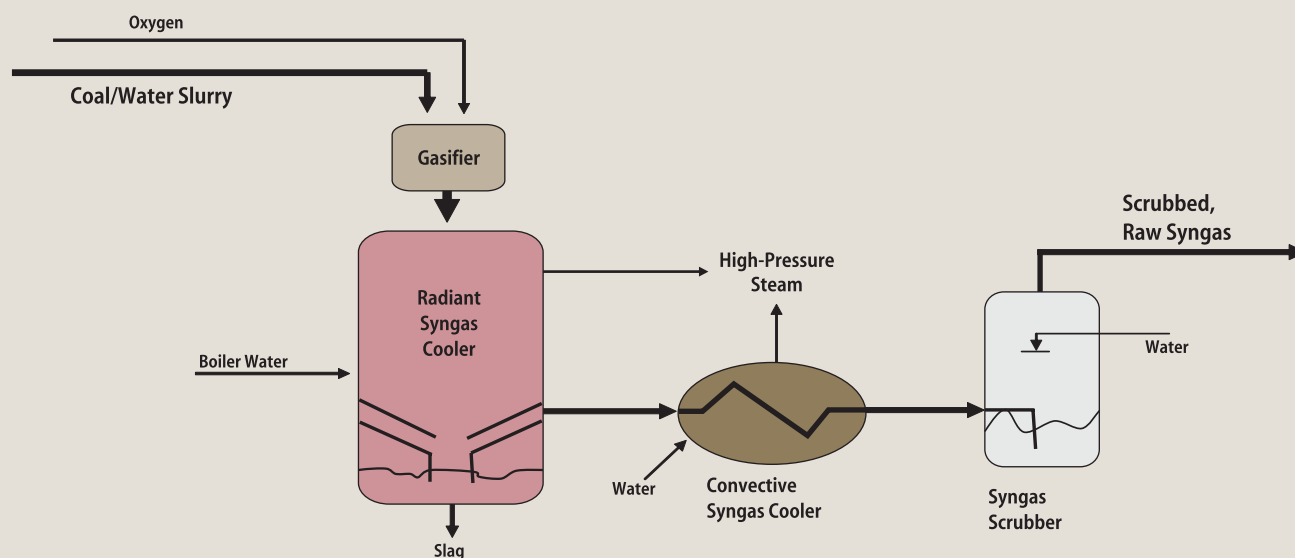
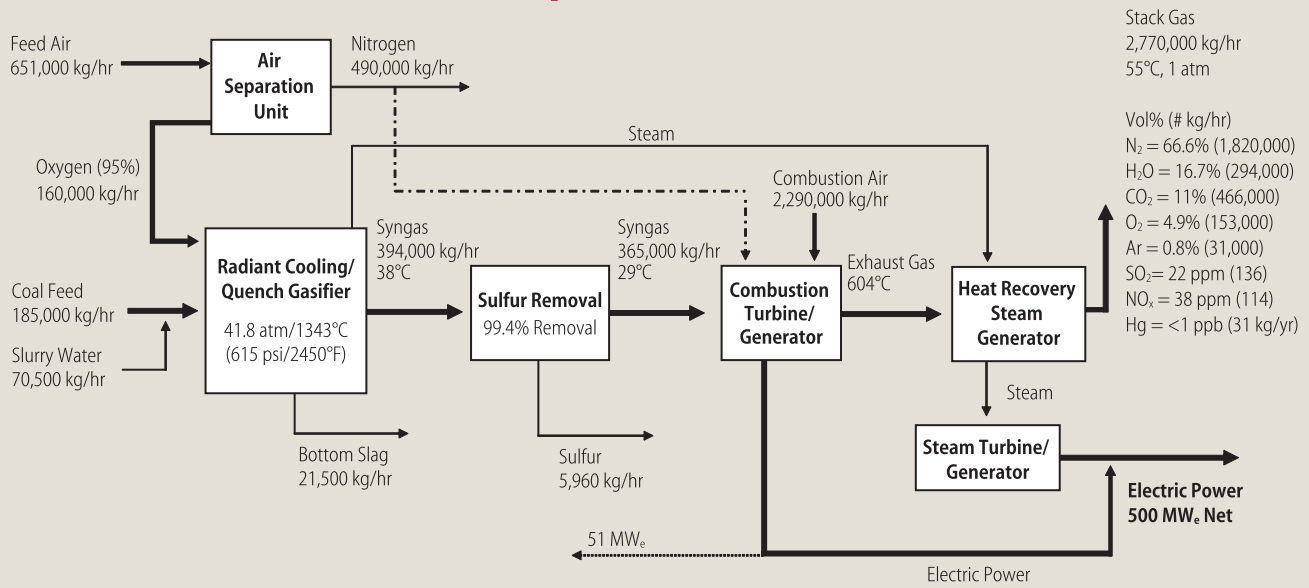

Figure A-3.B.11 is a detailed schematic of an oxygen-blown IGCC unit without CO<sub>2</sub> capture showing typical stream flows and conditions. In this case, a lower-pressure (4.2 MPa) GE radiant-cooling gasifier is used, producing high-pressure steam for electricity generation. Nitrogen from the ASU is fed to the combustion turbine to produce increased power and reduce NO<sub>x</sub> formation. Internal power consumption is about 90 MW<sub>e</sub>, and the net efficiency is 38.4%. MDEA can achieve 99.4% sulfur removal from the syngas for 0.033 lb SO<sub>2</sub>/million Btu, as low or lower than for recently permitted PC units. Selexol can achieve 99.8% sulfur removal for an emission rate of 0.009 lb SO<sub>2</sub>/million Btu. Rectisol, which is more expensive, can achieve 99.91% sulfur removal for an emissions rate of 0.004 lb SO<sub>2</sub>/million Btu [22]. NO<sub>x</sub> emission control is strictly a combustion turbine issue and is achieved by nitrogen dilution prior to combustion to reduce combustion temperature. Addition of SCR would result in NO<sub>x</sub> reduction to very low levels.

Figure A-3.B.12 shows the impact of adding CO<sub>2</sub> capture to a 500 MW<sub>e</sub> IGCC unit. The added units are a pair of shift reactors with inter-stage cooling to convert CO to hydrogen and CO<sub>2</sub> by reaction with steam. Because the shift reaction requires a lot of steam to drive it, an IGCC unit with CO<sub>2</sub> capture uses a direct-quench gasifier to maximize the steam in the syngas from the gasifier. CO<sub>2</sub> capture requires the addition of second Selexol unit, similar to the one used for sulfur removal. The CO<sub>2</sub> is desorbed from the capture solution by pressure reduction. The desorbed CO<sub>2</sub>, already at an intermediate pressure, is compressed to a supercritical liquid. Internal power consumption for the capture unit is about 130 MW<sub>e</sub> and

**Figure A-3.B.11 500 MW<sub>e</sub> IGCC Unit without CO<sub>2</sub> Capture**



coal consumption is about 23% higher. The overall efficiency is 31.2%. CO<sub>2</sub> separation and compression is favored by higher unit operating pressure, which requires higher pressure gasifier operation.

**IGCC OPERATIONAL PERFORMANCE** The promise of IGCC has been the potential of a smaller environmental footprint, including order-of-magnitude lower criteria emissions, of highly-efficient CO<sub>2</sub> capture, and of high generating efficiency. As discussed in Appendix 3-D, IGCC can provide a significantly smaller environmental footprint, and can also achieve close to order-of-magnitude lower criteria emissions, and very high levels of mercury removal. Available design studies do not clearly define the incremental cost to achieve these markedly lower criteria emissions. Recent studies suggest that adding SCR to the gas turbine exhaust and upgrading the upstream sulfur removal to accommodate it results in an incremental cost for the additional NO<sub>x</sub> removal of about \$13,000 to \$20,000 per ton NO<sub>x</sub> [22, 23].

**Figure A-3.B.12 500 MW<sub>e</sub> IGCC Unit with CO<sub>2</sub> Capture**

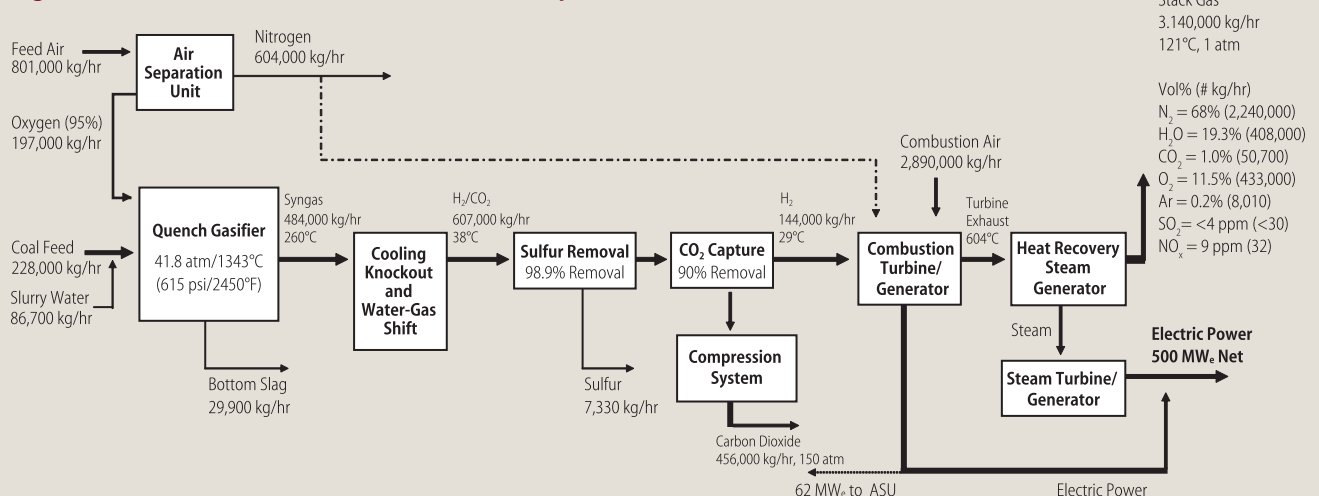

From design studies using high heating value coals, IGCC shows a distinct cost advantage for CO<sub>2</sub> capture over other coal-based electricity generating technologies with CO<sub>2</sub> capture. This advantage is expected to be demonstrated in commercial scale operation. However, this IGCC cost advantage will probably be significantly less for lower heating value coals, such as bituminous coals (e.g., PRB) and lignite. Data in this area are limited or lacking.

The electricity generating efficiencies demonstrated to date do not live up to earlier projections due to the many engineering design compromises that have been made to achieve acceptable operability and cost. The current IGCC units and next-generation IGCC units are expected to have electricity generating efficiencies that are less than or comparable to those of supercritical PC generating units. Current units typically gasify high-heating value, high-carbon fuels. Polk IGCC with a Texaco-GE water-slurry gasifier, radiant and convective syngas cooling but no combustion turbine-air separation unit integration operates at 35.4% (HHV) generating efficiency. The Wabash River IGCC with a water-slurry fed E-Gas gasifier, radiant and convective syngas cooling and no integration operates at about 40% generating efficiency. The IGCC in Puertollano Spain with a dry-feed Shell type gasifier, radiant and convective and combustion turbine-air separation unit integration has a generating efficiency of about 40.5% (HHV). Supercritical PC units operate in the 38 to 40% efficiency range, and ultra-supercritical PC units in Europe and Japan are achieving 42 to 46% (HHV) generating efficiency.

IGCC system and gasifier availability remains an important issue. Figure A-3.B.13 shows the availability history for the IGCC demonstration plants. These represent learning curves for the operation of a complex process with many component parts. No single process unit or component part of the total system was responsible for the majority of the unplanned shutdowns that reduced IGCC unit availability, although the gasification complex or block represents the largest factor in reduced availability and operability. For example, for Polk Power Station, the performance in terms of availability (for 1992, for 1993, and expected performance) was: for the air separation block (96%, 95%, & 96-98%); for the gasification block (77%, 78%, & 80-90%); and for the power block (94%, 80%, & 94-96%). A detailed analysis of the operating history of the Polk Power Station over the last few years suggests that it is very similar to operating a petroleum refinery, requiring continuous attention to avert, solve, and prevent mechanical, equipment and process problems that arise. In this sense, IGCC unit operation is significantly different than the operation of a PC unit, and requires a different operational philosophy and strategy.

Figure A-3.B.13 shows that most of the plants were able to reach the 70-80% availability after 4 to 6 years, and data on these units beyond this "learning curve" period show that they have been able to maintain availabilities in the 80% range (excluding planned shutdowns). By adding a spare gasifier, IGCC units should be able to exhibit availabilities near those of NGCC units. At the Eastman Chemical Gasification Plant, which has a full-quench Texaco gasifier and a backup gasifier (a spare), the gasification/syngas supply system has had less than a 2% forced outage over almost 20 years. Recent performance has been in excess of 98% including planned outages. Areas in the gasification block that require attention are gasifier refractory wear and replacement, coal-slurry pump and injector nozzles, and downstream syngas stream fouling.

Refinery-based IGCC units gasifying petroleum residua, tars and other wastes have experienced much better start-up histories and generally better operating statistics. Bechtel projects

**Figure A-3.B.13 History of IGCC Availability for the Start-up of Coal-based Units**  
(excluding operation on back-up fuel)

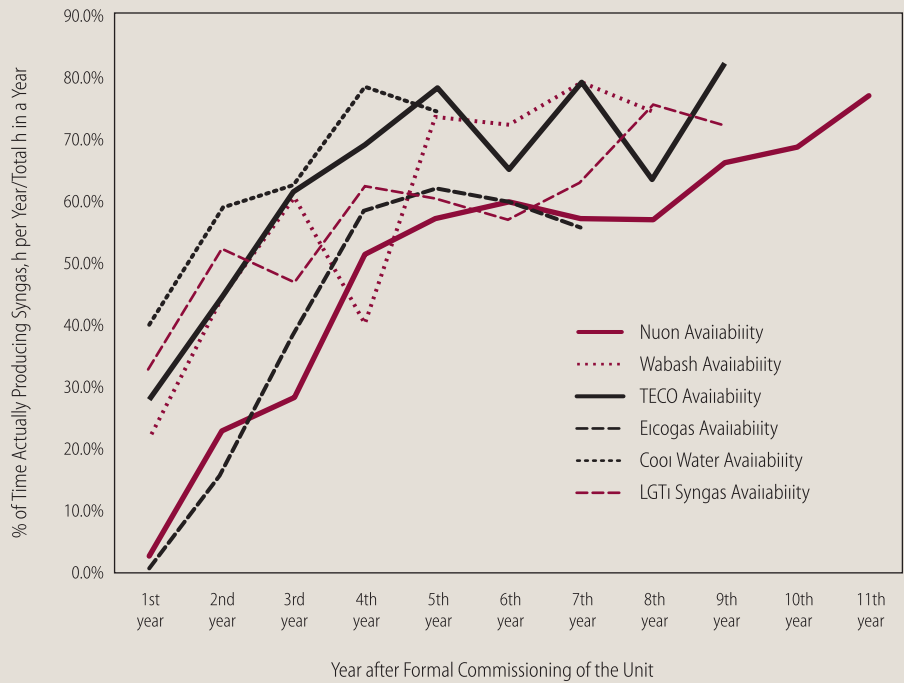

Graph provided by Jeff Phillips, EPRI

that future coal-based IGCC plants should achieve around 85% availability without back-up fuel or a spare gasifier [25].

IGCC units are primarily base-load units because their turndown is limited and somewhat complex. There is little information on turndown, but easy turndown to 50% is unlikely. The Negishi Japan IGCC unit is routinely turned down by 25% over a 30 minute period, so that it is operating at 75% of full capacity, to accommodate lower electric power demand at night and on weekends [26]. It is ramped up to full capacity operation over a 30 minute period when electricity demand increases again. Buggenum IGCC reports turndown to 57% of peak load at off-peak periods.

Integration between the ASU and the combustion turbine lowers total unit cost and NO<sub>x</sub> emissions, and increases efficiency and power output. Part or all of the ASU air may be supplied from the gas turbine compressor outlet to reduce or eliminate the need for a less-efficient ASU compressor. The degree of integration is defined as the fraction of the ASU air supplied from the combustion turbine. In general, 100% integration gives highest efficiency, but partial integration gives maximum power output and improved operability with shorter start-up times. The nitrogen from the ASU is typically used for NO<sub>x</sub> reduction and power augmentation to the extent compatible with the combustion turbine operating characteristics. The use of nitrogen instead of water injection is favored for NO<sub>x</sub> reduction because it results in higher operating efficiency. Current designs typically use partial air integration to achieve partial efficiency gain without sacrificing too much operability.

## CITATIONS AND NOTES

1. Williams, A., M. Pourkashanian, J. Jones, and N. Skorupska, *Combustion and Gasification of Coal*. Applied Energy Technology Series. 2000, New York: Taylor & Francis.
2. Smoot, L.D., & P. J. Smith, *Coal Combustion and Gasification*. The Plenum Chemical Engineering Series, ed. D. Luss. 1985, New York: Plenum Press.
3. Higman, C., and M. vanderBurgt, *Gasification*. 2003, New York: Elsevier.
4. Beer, J.M., *Combustion Technology Developments in Power Generation in Response to Environmental Challenges*. Elsevier Progress in Energy and Environmental Sciences, 2000. 26: p. 301-327.
5. The LHV of a fuel is the heat released upon combustion of the fuel with oxygen to form carbon dioxide and water at standard initial and end states with the water produced in the combustion remaining in the vapor state. For the HHV, the water produced in the combustion is condensed to liquid in the end state, releasing additional energy; the difference between the two heating values is the latent heat of condensation of the water from the fuel moisture and from the combustion of hydrogen in the fuel.
6. Generating efficiency is simply  $3600 \text{ (kJ/kW}_e\text{-h)}$  divided by the "heat rate" in  $\text{kJ/kW}_e\text{-h}$  or  $3414 \text{ (Btu/kW}_e\text{-h)}$  divided by the "heat rate" in  $\text{Btu/kW}_e\text{-h}$ .
7. Rubin, E., *Integrated Environmental Control Model 5.0*. 2005, Carnegie Mellon University: Pittsburgh.
8. Termuehlen, H., and W. Empsperger, *Clean and Efficient Coal Fired Power Plants*. 2003: ASME Press. Fig. 2.3.
9. Parsons, E.L., W. W. Shelton, & J. L. Lyons, *Advanced Fossil Power Systems Comparison Study*. 2002a, NETL: Morgantown, WV.
10. Numbers for Subcritical PC and the other generating technologies evaluated in this report are typical of industrial practice and the NETL "Advanced Fossil Power Systems Comparison Study". To ensure consistency among the technologies compared, the numbers here were all generated by the Carnegie Mellon "Integrated Environmental Control Model 5.0 (See Rubin).
11. Booras, G., and N. Holt, *Pulverized Coal and IGCC Plant Cost and Performance Estimates*, in *Gasification Technologies 2004*. 2004: Washington, DC.
12. NCC, *Opportunities to Expedite the Construction of New Coal-Based Power Plants*. 2004, National Coal Council.
13. Jaeger, H., *Japan 250 MW Coal Based IGCC Demo Plant Set for 2007 Start-up*. Gas Turbine World, 2005. 35(2): p. 12-15.
14. DOE (2004) *Secretary Abraham Announces \$235 Million for Florida Clean Coal Plant*. Fossil Energy Techline, Oct. 21, 2004, [http://www.fossil.energy.gov/news/techlines/2004/TI\\_CCPiZ\\_southernco.html](http://www.fossil.energy.gov/news/techlines/2004/TI_CCPiZ_southernco.html).
15. Rush, R., *America's Advanced Coal Research Center*, in *2005 Security Analyst Meeting; Charting the Course*. 2005, Southern Company.
16. Smith, P., *KBR Transport Gasifier*, in *Gasification Technologies 2005*. 2005: San Francisco, CA.
17. Holt, N., G. Booras, and D. Todd, *Summary of Recent IGCC Studies of CO2 Capture for Sequestration*, in *MIT Carbon Sequestration Forum IV*. 2003: Cambridge, MA.
18. IEA, *Canadian Clean Power Coalition - Studies of CO2 Capture and Storage*. 2004a.
19. Holt, N., *Gasification & IGCC - Status, Challenges, Design Issues & Opportunities*, in *Reaction Engineering International*. 2005: Salt Lake City, Utah.
20. IEA, *Potential for Improvements in Gasification Combined Cycle Power Generation with CO2 Capture*. 2003, International Energy Agency Greenhouse Gas R&D Programme: Cheltenham, UK. p. 788.
21. Holt, N., *Gasification and IGCC - Status, Challenges, Design Issues & Opportunities*, in *Reaction Engineering International*. 2005.
22. Nexant, *Environmental Footprints and Costs of Coal-based Integrated Gasification Combined Cycle and Pulverized Coal Technologies*, in *Clean Air Markets*, EPA, Editor. 2006, Nexant, Inc.: San Francisco. p. 4-1 to 4-14.
23. Kentuckiana\_Engin\_Co., *Prevention of Significant Deterioration Construction Permit Application*. 2006, Kentuckiana Engineering Company, Inc.: Louisville. p. 4-1 to 1-70.
24. Phillips, J., *Integrated Gasification Combined Cycles with CO2 Capture*, in *GCEP Research Symposium*. 2005: Stanford University.
25. Schmoe, L., *IGCC -- Expected Plant Availabilities and Efficiencies*, in *Platts IGCC Symposium*. 2005: Pittsburgh.
26. Yamaguchi, M., *First Year of Operational Experience with the Negishi IGCC*, in *Gasification Technologies 2004*. 2004: Washington, D.C.

## Appendix 3.C — Electricity Generation Economics: Bases and Assumptions

### LEVELIZED COST OF ELECTRICITY

The levelized cost of electricity (COE) is the constant dollar electricity price that would be required over the life of the plant to cover all operating expenses, payment of debt and accrued interest on initial project expenses, and the payment of an acceptable return to investors. Levelized COE is comprised of three components: capital charge, operation and maintenance costs, and fuel costs. Capital cost is generally the largest component of COE. This study calculated the capital cost component of COE by applying a carrying charge factor of 15.1% to the total plant cost (TPC) which could also be called the total unit cost. This procedure is in accordance with the EPRI Technology Assessment Guide (TAG) [1], and is based on the financial assumptions presented in Table A-3.C.1.

**Table A-3.C.1 Key Financial Assumptions Applied in Capital Cost Evaluation**

ASSUMPTION	VALUE
Fraction debt	55%
Cost of debt	6.5%
Cost of equity	11.5%
Tax rate	39.2%
Inflation rate	2%
Construction period	3 years
Book life	20 years

### CRITICAL EVALUATION OF DESIGN AND COST STUDIES

Seven coal technology design and cost studies were reviewed and critically analyzed for this report. These studies, published since 2000, typically estimate the required capital cost and levelized cost of electricity (COE) for current coal-based generating technologies. Most of these studies also estimated the cost of electricity for these technologies with CO<sub>2</sub> capture. The capital costs for each study were developed independently and thus exhibited considerable variation. Further, the financial and operating assumptions that were used to calculate the COE varied from study to study which also added variability to the COE. Several studies that were on a substantially different basis or fell well outside the range expected were not included in the analysis because there was no adequate way to effectively evaluate them. For example, several IEA GHG reports that we reviewed appeared to underestimate systematically capital costs, had generating efficiencies that typically would not be achieved under U.S. conditions, and were not used [2, 3]. Table A-3.C.2 lists these studies, and Table A-3.C.3 summarizes the key technical, operational, and financial parameters for the cases evaluated for PC generation, including oxy-fuel and CFB generation. Table A-3.C.4 provides a similar summary for the IGCC cases.

**Table A-3.C.2 Primary Design Studies Reviewed in Developing Coal-Based Power Generation Economics**

STUDY/YEAR	PULVERIZED COAL	IGCC	CAPTURE
EPRI/ Parsons 2002 [4]	Supercritical & Ultra-Supercritical PC	E-gas	Yes
NETL 2002 [5]	Subcritical & Oxy-fuel PC	E-gas & Shell	Yes
Simbeck 2002 [6]	Ultra-Supercritical PC	GE/Texaco	Yes
Rubin 2004 [7]	Supercritical PC	GE/Texaco	Yes
NCC 2004 [8]	Subcritical & Supercritical PC	E-gas	No
NCC 2004 [8]	Circulating Fluidized Bed (CFB)		No
Dillon 2004 [9]	Supercritical & Oxy-fuel PC	—	Yes
Andersson 2003 [10]	Supercritical & Oxy-fuel PC	—	Yes

**Table A-3.C.3 Summary of Design Studies of PC And CFB Generation — As Reported**

STUDY	NETL 2002[5]	NETL 2002[5]	NCC 2004	EPRI 2002[4]	NCC [11]	RUBIN [7]	EPRI 2002 [4]	SIM-BECK [6]	DILLON [9]	ANDERSSON [10]	NCC [8]
Technology	subC	subC	SubC	SC	SC	SC	USC	USC	SC	SC	CFB
Cost year basis	2002	2002	2003	2000	2003	2004	2000	2000	2004	2004	2003
<b>Baseline</b>											
Efficiency (% HHV)	37.4		36.7	40.5	39.3	39.3	42.8	43.1	42.5	38.3	34.8%
TPC (\$/kW <sub>e</sub> )	1114		1230	1143	1290	1076	1161	1290	1260	1271	1290
TCR (\$/kW <sub>e</sub> )	1267		1430	1281	1490	1205	1301	1445	1411	1424	1490
Annual CC (% on TPC)	16.8		14.3	15.5	14.2	16.6	15.5	15.0			15.1%
Fuel price (\$/MMBtu)	0.95		1.5	1.24	1.5	1.27	1.24	1.00			1.00
Capacity Factor (%)	85		80	65	80	75	65	80			85%
Electricity cost											
Capital charge (cents/kWh <sub>e</sub> -h)	2.52		2.51	3.10	2.62	2.71	3.15	2.77			2.61
O&M (cents/kWh <sub>e</sub> -h)	0.8		0.75	1	0.75	0.79	0.95	0.74		0.42	1.01
Fuel (cents/kWh <sub>e</sub> -h)	0.87		1.39	1.04	1.30	1.10	0.99	0.79			0.98
<b>COE (¢/kWh<sub>e</sub>-h)</b>	<b>4.19</b>		<b>4.65</b>	<b>5.15</b>	<b>4.67</b>	<b>4.61</b>	<b>5.09</b>	<b>4.30</b>	<b>4.4</b>		<b>4.60</b>
<b>Capture</b>											
	MEA	Oxy-fuel		MEA		MEA	MEA	MEA	Oxy-fuel	Oxy-fuel	
Efficiency (% HHV)	26.6	29.3		28.9		29.9	31.0	33.8	34.0	30.2	
TPC (\$/kW <sub>e</sub> )	2086	1996		1981		1729	1943	2244	1857	2408	
TCR (\$/kW <sub>e</sub> )	2373	2259		2219		1936	2175	2513	2080	2697	
Annual carrying charge (%)	16.8	16.8		15.5		16.6	15.4	15.0			
Fuel price (\$/MMBtu)	0.95	0.95		1.24		1.27	1.24	1			
Capacity Factor	85	85		65		75	65	80			
Electricity cost											
Capital charge (cents/kWh <sub>e</sub> -h)	4.72	4.49		5.38		4.36	5.27	4.80			
O&M (cents/kWh <sub>e</sub> -h)	1.67	1.23		1.71		1.6	1.61	1.28			
Fuel (cents/kWh <sub>e</sub> -h)	1.22	1.11		1.46		1.45	1.36	1.01		0.86	
<b>COE (¢/kWh<sub>e</sub>-h)</b>	<b>7.61</b>	<b>6.83</b>		<b>8.55</b>		<b>7.41</b>	<b>8.25</b>	<b>7.09</b>	<b>6.1</b>		

Note: For Rubin, TCR assumed 12% higher than TPC as per EPRI TAG

To allow comparison of capital costs, O&M costs, and the COE among these studies, each was reevaluated using a common set of operating and economic parameters. In addition to the economic parameters in Table A-3.C.1, a capacity factor of 85%, and a fuel cost of \$1.50/million Btu (HHV) for the PC and IGCC cases, and \$1.00/million Btu (HHV) for the CFB case. The rationale for the lower fuel price for the CFB case is that CFB technology is ideally suited for low-quality coals such as coal waste, and low heating value coals such as lignite, both of which are typically lower cost.

Each study was adjusted to a 2005 year cost basis. Adjustment factors for inflation, taken from the U.S. Department of Labor consumer price index, were used to normalize the studies to a constant 2005 cost year basis. These are given in Table A-3.C.5. The results of the re-evaluation using the normalized economic and operating parameters are presented in Tables A-3.C.6 and A-3.C.7 for the PC and CFB, and the IGCC cases, respectively. Two studies (Andersson [10] and Dillon [9]) did not provide sufficient information to normalize and are not included in these tables.



**Table A-3.C.4 Summary of Design Studies of IGCC Generation  
— As Reported**

STUDY	EPRI 2002[4]	RUBIN[7]	SIMBECK[6]	NCC[11]	NETL 2002[5]
Technology	E-Gas	Texaco	Texaco	E-Gas	E-Gas
Cost year basis	2000	2004	2000	2003	2002
<b>Baseline</b>					
Efficiency (% HHV)	43.1	37.5	43.1	39.6	44.90
TPC (\$/kW <sub>e</sub> )	1111	1171	1293	1350	1167
TCR (\$/kW <sub>e</sub> )	1251	1311	1448	1610	1374
Fuel price (\$/MMBtu)	1.24	1.27	1	1.5	0.95
Capacity Factor (%)	65	75.0	80	80	85
Electricity cost					
Capital charge (¢/kW <sub>e</sub> -h)	3.03	2.95	2.77	2.80	2.73
O&M (¢/kW <sub>e</sub> -h)	0.76	0.72	0.74	0.89	0.61
Fuel (¢/kW <sub>e</sub> -h)	0.98	1.16	0.79	1.29	0.72
<b>COE (¢/kW<sub>e</sub>-h)</b>	<b>4.77</b>	<b>4.83</b>	<b>4.30</b>	<b>4.99</b>	<b>4.06</b>
<b>Capture</b>					
Efficiency (% HHV)	37.0	32.4	37.7		38.6
TPC (\$/kW <sub>e</sub> )	1642	1561	1796		1616
TCR (\$/kW <sub>e</sub> )	1844	1748	2012		1897
Annual carrying charge (%)	15.5	16.6	15.0		17.4
Fuel price (\$/MMBtu)	1.24	1.27	1		1
Capacity Factor	65	75	80		85
Electricity cost					
Capital charge (¢/kW <sub>e</sub> -h)	4.47	3.94	3.85		3.77
O&M (¢/kW <sub>e</sub> -h)	0.96	0.98	1.03		0.79
Fuel (¢/kW <sub>e</sub> -h)	1.14	1.34	0.91		0.88
<b>COE (¢/kW<sub>e</sub>-h)</b>	<b>6.57</b>	<b>6.26</b>	<b>5.78</b>		<b>5.44</b>

Note: For Rubin and Simbeck, TCR assumed 12% higher than TPC as per EPRI TAG

**Table A-3.C.5 Inflation Adjustment  
Factor to Year 2005 Dollars**

YEAR	ADJUSTMENT FACTOR
2000	1.11
2001	1.08
2002	1.07
2003	1.05
2004	1.03

**Table A-3.C.6 Results of Design Study Normalization to Consistent Economic and Operational Parameters — PC and CFB**

STUDY	NETL 2002	NETL 2002	NCC 2004	EPRI 2002	NCC	RUBIN	EPRI 2002	SIMBECK	NCC
Technology	SubC	SubC	SubC	SC	SC	SC	USC	USC	CFB
<b>Baseline</b>									
TPC (\$/kW <sub>e</sub> )	1192		1292	1269	1355	1108	1289	1432	1329
TCR (\$/kW <sub>e</sub> )	1356		1502	1422	1565	1241	1444	1604	1535
Capital charge (¢/kW <sub>e</sub> -h)	2.42		2.62	2.57	2.75	2.25	2.61	2.90	2.69
O&M (¢/kW <sub>e</sub> -h)	0.86		0.79	1.11	0.79	0.81	1.05	0.82	1.04
Fuel (¢/kW <sub>e</sub> -h)	1.37		1.39	1.26	1.30	1.30	1.20	1.19	0.98
<b>COE (¢/kW<sub>e</sub>-h)</b>	<b>4.64</b>		<b>4.80</b>	<b>4.95</b>	<b>4.84</b>	<b>4.36</b>	<b>4.86</b>	<b>4.91</b>	<b>4.72</b>
<b>Capture</b>									
	MEA	Oxy-fuel		MEA		MEA	MEA	MEA	
TPC (\$/kW <sub>e</sub> )	2232	2136		2199		1780	2157	2491	
TCR (\$/kW <sub>e</sub> )	2539	2417		2463		1994	2414	2790	
Capital charge (¢/kW <sub>e</sub> -h)	4.53	4.33		4.46		3.61	4.37	5.05	
O&M (¢/kW <sub>e</sub> -h)	1.79	1.32		1.90		1.65	1.79	1.42	
Fuel (¢/kW <sub>e</sub> -h)	1.92	1.75		1.77		1.71	1.65	1.51	
<b>COE (¢/kW<sub>e</sub>-h)</b>	<b>8.24</b>	<b>7.39</b>		<b>8.13</b>		<b>6.97</b>	<b>7.81</b>	<b>7.99</b>	

**Table A-3.C.7 Results of Design Study Normalization to Consistent Economic and Operational Parameters — IGCC**

STUDY	EPRI 2002	RUBIN	SIMBECK	NCC	NETL 2002
Technology	E-Gas	Texaco	Texaco	E-Gas	E-Gas
<b>Baseline</b>					
TPC (\$/kW <sub>e</sub> )	1233	1206	1435	1418	1249
TCR (\$/kW <sub>e</sub> )	1389	1350	1607	1691	1470
Capital charge (¢/kWh)	2.50	2.44	2.91	2.87	2.53
O&M (¢/kW <sub>e</sub> -h)	0.84	0.74	0.82	0.93	0.65
Fuel (¢/kW <sub>e</sub> -h)	1.19	1.36	1.19	1.29	1.14
<b>COE (¢/kW<sub>e</sub>-h)</b>	<b>4.53</b>	<b>4.55</b>	<b>4.92</b>	<b>5.10</b>	<b>4.32</b>
<b>Capture</b>					
TPC (\$/kW <sub>e</sub> )	1823	1608	1994		1729
TCR (\$/kW <sub>e</sub> )	2047	1800	2233		2030
Capital charge (¢/kW <sub>e</sub> -h)	3.70	3.26	4.04		3.51
O&M (¢/kW <sub>e</sub> -h)	1.07	1.01	1.14		0.85
Fuel (¢/kW <sub>e</sub> -h)	1.38	1.58	1.36		1.33
<b>COE (¢/kW<sub>e</sub>-h)</b>	<b>6.14</b>	<b>5.85</b>	<b>6.54</b>		<b>5.68</b>

**Figure A-3.C.1 Total Plant Cost from Design Studies of Air-Blown Generating Technologies (2005 Dollars)**

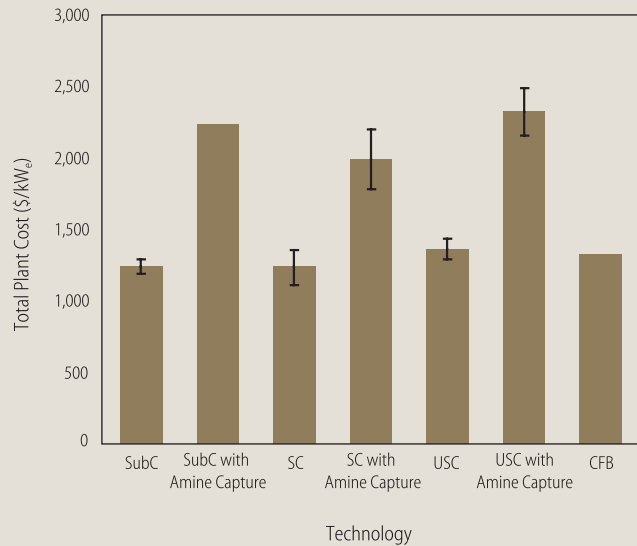

**Figure A-3.C.2 Total Plant Cost from Design Studies of Oxygen-Blown Generating Technologies (2005 Dollars)**

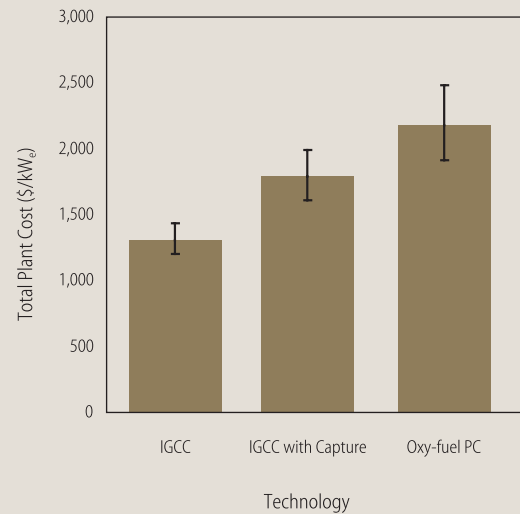

Figure A-3.C.1 shows the min, max, and mean for the TPC for each of the air-blown generating technologies from the design studies, expressed in 2005 dollars. Figure A-3.C.2 shows the same information for each of the oxygen-blown generating technologies. Figure A-3.C.3 and Figure A-3.C.4 show the min, max, and mean for the COE from these same studies both “as-reported” and as recalculated in 2005 dollars using the normalized set of economic and operating parameters summarized in Table 3.5.

### ADDRESSING UNCERTAINTY AND FORWARD SIMULATION

Our economic analyses of total and marginal COE are for a single point set of conditions, and do not take into account the considerable uncertainty in many of the variables upon which these point COE values are based. Plant capital cost (TPC) is one of the major contributors to COE. The capital cost basis used here was developed in the 2000 to 2004 time period, which was a period of relative price and cost stability. These costs were all put on a 2005\$ basis using CPI inflation. Recent global economic growth, including China’s rapid growth, have driven up commodity prices, engineering costs, and construction costs much more than the CPI increase in the last three years. These construction cost related increases have driven increases in the capital cost (TPC) of from 25 to 35 % from 2004 levels. This is reflected in a capital cost range recently reported by Dalton [12] of \$1290 to \$1790 /kW<sub>e</sub> for a SCPC unit, considerably above earlier projections[13] (see also Figure A-3.C.1). If world economic growth were to substantially slow, these costs would reduce significantly. Because we have no firm information on how these cost increases would affect the other generating technologies involved, including those with CO<sub>2</sub> capture, and because our main interest is in comparing the full range of technologies, we have based our discussion on the design estimates referenced here and not escalated them to capture today’s construction cost environment.

Because electricity prices from forward market quotes are generally not available, the cost of generation is the proxy for the market. As such, forward projected cost of generation

**Figure A-3.C.3 COE from Design Studies of Air-Driven Generating Technologies — “As-Reported” and for Normalized Economic and Operating Parameters**

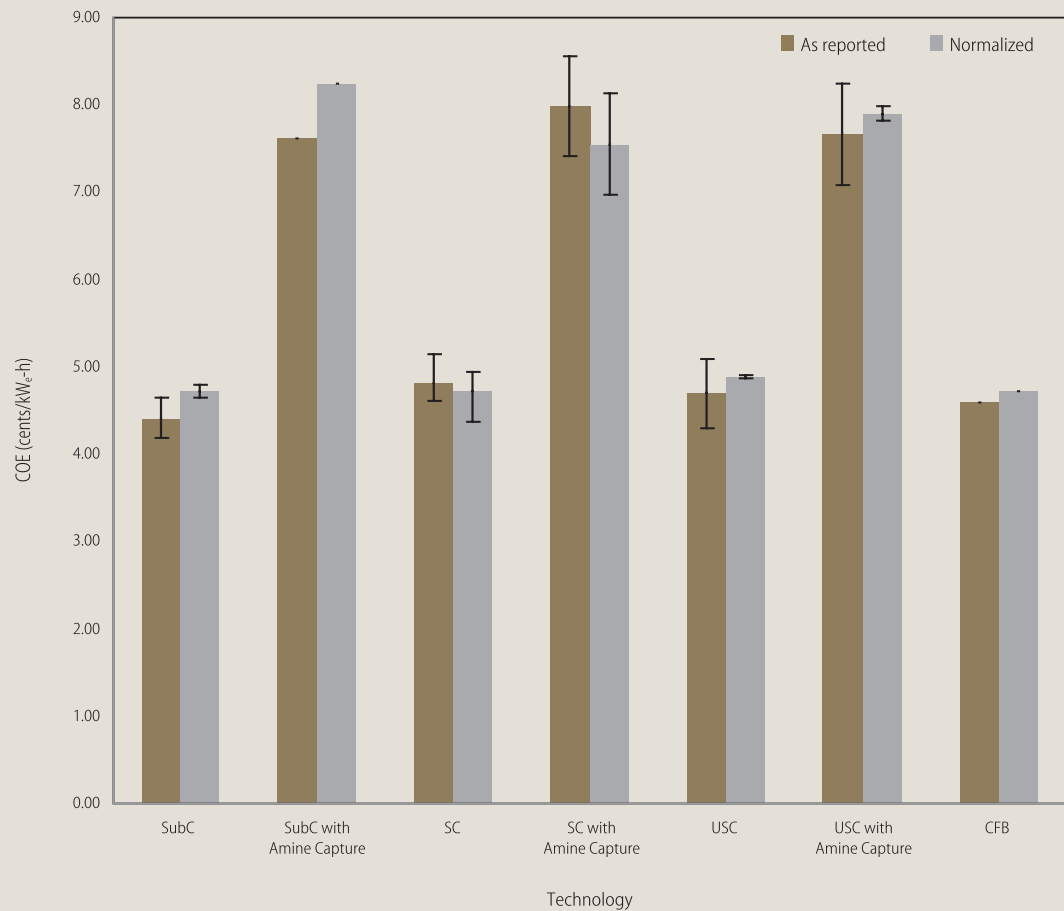

(NPV cost) and the effect of uncertainty in key variables on this cost is the most relevant approach to comparing technologies for future construction.

Major variables affecting NPV cost include:

- Plant capital cost (TPC) (discussed above)
- Coal price and fuel flexibility
- O&M cost
- Capacity factor and plant dispatch
- Air pollutant regulations and costs, including SO<sub>x</sub>, NO<sub>x</sub>, and mercury
- Future greenhouse gas policy and CO<sub>2</sub> costs
- Marketable by-products

Each of these variables have significant uncertainties associated with cost, technology, performance, and timing. One way to evaluate the impact of these variables is to perform a numerical simulation. For example, a Monte Carlo-type simulation produces a sensitivity analysis that shows how changes in any one of these variables affects the economics of

a given generating technology or plant [14]. Simulation requires building a set of forward assumptions of the value, of the bounds, and of associated probability distribution function for each of the variables. A simulation is then performed producing a probability distribution function for the results of the analysis. From this, the probability of the NPV cost for the plant can be projected for a given set of conditions for each generating technology.

An example of how an uncertainty simulation can be used is with regulations of criteria air contaminants. At today's environmental costs and with no CO<sub>2</sub> policy, PC generation has a lower COE and is favored in terms of having the lowest NPV cost. However, as allowed future pollutant emissions levels are reduced and the cost of emissions control increases, the NPV gap between PC and IGCC will narrow; and at some point, increased emissions control can be expected to lead to IGCC having the lower NPV. This, of course, depends on when and the extent to which these changes occur and on how emissions control technology costs change with time and increasing reduction requirements.

In the case of CO<sub>2</sub>, uncertainty surrounds the timing, the form (tax or cap) and level of CO<sub>2</sub> controls. Assuming a carbon tax, variables would include:

- Year of introduction of tax
- Initial tax rate
- Annual increase in the tax rate.

The introduction of a CO<sub>2</sub> tax at a future date (dependent on date, CO<sub>2</sub> tax rate, and rate of increase) will drive IGCC to be the lowest NPV cost alternative at some reasonable set of assumptions, and assuming today's technology performance. Substantial technology innovation could change the outcome, as could changing the coal feed from bituminous coal to lignite.

This type of analysis is widely used in evaluating the commercial economics of large capital projects, but is outside the scope of this report. Nevertheless, its importance in forward planning relative to coal-based generating technology needs to be acknowledged. AEP decided to build two IGCC plants, using analysis of this type to help make the decision internally and to support the decision externally [15].

**Figure A-3.C.4 COE from Design Studies of Oxygen-Blown Generating Technologies — “As-Reported” and for Normalized Economic and Operating Parameters**

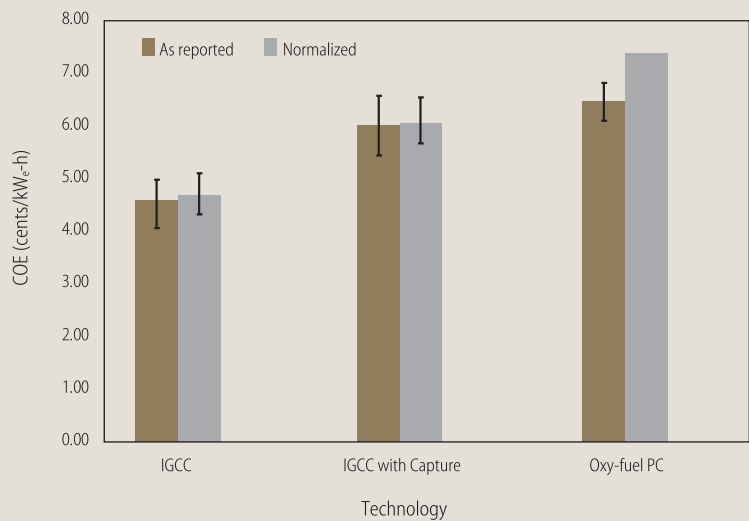

## CITATIONS AND NOTES

1. EPRI, *Financial Incentives for Development of IGCC: A Coal-Fleet Working Paper*. 2005, EPRI.
2. IEA, *Leading Options for the Capture of CO<sub>2</sub> Emissions at Power Stations*. 2000, International Energy Agency Greenhouse Gas R&D Programme: Cheltenham UK.
3. IEA, *Potential for Improvements in Gasification Combined Cycle Power Generation with CO<sub>2</sub> Capture*. 2003, International Energy Agency Greenhouse Gas R&D Programme: Cheltenham, UK. p. 788.
4. Parsons Infrastructure & Technology Group, I., *Updated Cost and Performance Estimates for Fossil Fuel Power Plants with CO<sub>2</sub> Removal*. 2002: Pittsburgh, PA & Palo Alto, Calif.
5. NETL, *Advanced Fossil Power Systems Comparison Study*, W.W.S. E. L. Parsons (NETL), and J.L. Lyons, Editor. 2002, NETL.
6. Simbeck, D., *New Power Plant CO<sub>2</sub> Mitigation Costs*. 2002, SFA Pacific, Inc.: Mountain View, CA.
7. Rubin, E.S., A. B. Rao, and C. Chen. *Comparative Assessments of Fossil Fuel Power Plants for CO<sub>2</sub> Capture and Storage*. in *Proceedings of 7th International Conference on Greenhouse Gas Control Technologies*. 2004.
8. NCC, *Opportunities to Expedite the Construction of New Coal-Based Power Plants*. 2004, National Coal Council.
9. Dillon, D.J., R. S. Panesar, R. A. Wall, R. J. Allam, V. White, J. Gibbins, and M. R. Haines, *Oxy-combustion Processes for CO<sub>2</sub> Capture from Advanced Supercritical PF and NGCC Power Plant*, in *Greenhouse Gas Technologies Conference 7*. 2004: Vancouver, BC.
10. Andersson, K., H. Birkestad, P. Maksinén, F. Johnsson, L. Stromberg, and A. Lyngfelt, ed. *An 865 MW Lignite Fired CO<sub>2</sub> Free Power Plant- A Technical Feasibility Study*. Greenhouse Gas Control Technologies, ed. K. Gale. 2003, Elsevier Science Ltd.: New York.
11. NCC, *Research and Development Needs and Deployment Issues for Coal-Related Greenhouse Gas Management*. 2003, The National Coal Council.
12. Dalton, S., *Carbon Capture and Sequestration Technologies*, in *Climate Change Workshop*. 2006: Edison Electric Foundation, Washington, DC.
13. Booras, G., and N. Holt, *Pulverized Coal and IGCC Plant Cost and Performance Estimates*, in *Gasification Technologies 2004*. 2004: Washington, DC.
14. Humphreys, K., ed. *Jellen's Cost and Optimization Engineering*. Third Edition ed. 1991, McGraw-Hill, Inc.: New York.
15. Mudd, M., *Testimony before The Public Utilities Commission of Ohio*. 2005.

## EMISSIONS REGULATIONS

The Clean Air Act requires the U.S. EPA to establish nationally applicable National Ambient Air Quality Standards (NAAQS) for each air pollutant which, in the EPA Administrator's judgment, causes or contributes to the endangerment of public health and welfare, and which results from domestic mobile or stationary sources. The EPA to date has issued seven such standards, for ozone, carbon monoxide, sulfur dioxide, lead, nitrogen dioxide, coarse particulates ( $PM_{10}$ ), and fine particulates ( $PM_{2.5}$ ). The Act further requires that these standards be reviewed and updated every five years. Most recently, the Agency issued revised ozone and particulate matter standards in 1997 [1], as well as an entirely new standard for small particulates. Once the standards are issued, areas are designated as in "attainment" or "non-attainment" of each standard. For example, EPA in December 2004 finalized regional compliance designations for the new NAAQS standards for fine particulates [1].

The NAAQS form the basis for the federal ambient air quality program, also known as Title I, which is administered by the states and the federal government cooperatively. Under this program, each state must submit, and EPA must approve, a State Implementation Plan (SIP). Each state's SIP must describe, among other things, how the state plans to come into compliance, and/or stay in compliance with each NAAQS, through various mobile and stationary source programs, and must include provisions related to the review and approval of required air quality permits for new and modified stationary sources. A SIP may include provisions that are more, but not less, stringent than Federal requirements.

Another section of Title I authorizes EPA to retract or "call in" state SIPs, if it finds that pollution emissions in one state or several states are causing or contributing to downwind non-attainment or difficulty attaining the NAAQS in other states. This is referred to as a SIP Call, and EPA has issued such a rule (the  $NO_x$  SIP Call) for  $NO_x$  emissions in the eastern half of the US, which cause and contribute to downwind non-attainment of the ozone NAAQS.

Additionally, other provisions of the Clean Air Act authorize federal programs for air pollution control, which are implemented through the SIPs. For example, Title IV of the Act authorizes the Acid Rain Program [2], which was enacted by Congress in 1990. Title IV sets up a cap and trade system for sulfur dioxide ( $SO_2$ ) and emissions of nitrogen oxides ( $NO_x$ ). The  $SO_2$  program was initially limited to the 440 largest utility units, and now covers all affected sources nationwide (over 2000 units).  $NO_x$  emissions control has been phased in, by setting limits on the amount of  $NO_x$  that can be emitted per unit of fuel consumed, based on the goal of reducing  $NO_x$  by 2 million tons per year below a BAU number.

Local air quality issues are very important in establishing permitted emission levels for new coal plants and other new stationary sources. In the permitting of each new coal unit under "new source review," emissions levels are set based on federal New Source Performance Standards requirements, and based on the local area's air quality designation for each criteria pollutant. In areas that are in attainment for a criteria pollutant, a new facility must meet an emissions limit based on the Best Available Control Technology (BACT), determined through a federally-directed "top-down" process. In non-attainment areas, the source must meet the Lowest Achievable Emissions Rate (LAER). The Clean Air Act states that BACT

determinations can include consideration of the costs of achieving lower emissions levels; whereas LAER determinations must be strictly based on the most stringent emissions rate achieved by the same class or category of source. In addition, new units permitted in non-attainment areas are required to purchase emissions offsets equal to their emissions.

In March 2005, EPA enacted the Clean Air Interstate Rule (CAIR) [3], under the same legal authority as the NO<sub>x</sub> SIP Call, to reduce atmospheric interstate transport of fine particulate matter and ozone. CAIR sets up a cap-and-trade program allocating emission “allowances” of the PM and ozone precursors SO<sub>2</sub> and NO<sub>x</sub> to each state. The program is to be administered through the affected states’ SIPs. Figure A-3.D.1 shows EPA’s projection of NO<sub>x</sub> and SO<sub>2</sub> emissions with the final rule’s CAIR caps [4, 5]. The figure also shows the projection for electricity generation using coal as fuel. CAIR applies to 28 eastern states and the District of Columbia. While CAIR does not require emissions reductions from any particular industrial sector, but leaves it to the states to decide how the caps will be achieved, it is widely accepted that the power sector will be the most cost-effective place to achieve the required reductions. Power plants may (a) install control equipment, (b) switch fuels, or (c) buy excess allowances from other sources that have achieved greater reductions, to satisfy state requirements under the CAIR.

This context complicates the permitting of new coal power plants under “new source review”. Permitting a new plant in an attainment area involves negotiations with state and local agencies. The plant is federally mandated to meet BACT, for which there is some flexibility in interpretation and cost considerations. However, negotiations usually start at emissions levels lower than this and often lower than the levels of the latest permits. Permitted levels for a give plant are the result of these negotiations and continue to be reduced with each permit cycle. A new coal plant located in a non-attainment area will have to meet a lower emissions rate for the non-attainment pollutant. In addition to having to meet the LAER emissions rate, local and state authorities are typically under pressure to meet their SIP requirements with additional gains wherever they can achieve them. Thus, the coal plant in a non-attainment area will typically incur higher total emissions control costs which include the capital and operating costs for the enhanced emissions control equipment, the cost of the potential purchases of emissions allowances, and the cost of emissions offset purchases for that pollutant.

Also in March 2005, EPA issued the Clean Air Mercury Rule (CAMR) [6], which establishes a cap-and-trade system for mercury emissions from power plants. This rule applies to 50 states, the District of Columbia, and certain Tribal governments. Each is allocated an emissions “budget” for mercury, although states can opt out of the cap and trade program and administer a more stringent emissions reduction program than is required by CAMR. In the early years of the rule, EPA projects that states will be able to meet their budgets solely on the basis of the “co-benefits” of CAIR emissions reductions. This rule was issued as an alternative to the Clean Air Act’s requirement that maximum achievable control technology (MACT) standards must be applied to all industrial sources of hazardous air pollutants. MACT standards would require much lower emissions of mercury, and in the nearer term.

Table A-3.D.1 gives EPA’s projections for NO<sub>x</sub>, SO<sub>2</sub>, and mercury emissions for both rules [3, 6]. Of 75 tons of mercury in the coal that is burned annually in the U.S. today, about 50 tons are emitted to the air [7]. The roughly 25 ton reduction is achieved through existing pollution control equipment, primarily fly ash removal by electrostatic precipitators and fabric filters, and wet FGD scrubbers for SO<sub>x</sub> removal. The first phase of mercury reduction



is designed to be achieved through the actions taken in the first phase of CAIR.

Table A-3.D.2 projects the NO<sub>x</sub>, SO<sub>2</sub>, and mercury emissions for both rules to 2020. In addition to the early mercury reductions being credited to CAIR implementation, the emissions without CAIR include all the reductions that would occur due to the Title IV Acid Rain Program, the NO<sub>x</sub> SIP Call, and state rules finalized before March, 2004. The projections are higher than the cap limits because of the banking of excess emissions reductions under the Acid Rain Program and their use later.

### EMISSIONS CONTROL FOR PULVERIZED COAL COMBUSTION

Typical flue gas cleaning configurations for PC power plants are shown in Figure A-3.D.2.

**PARTICULATE CONTROL** Particulate control is typically accomplished with electrostatic precipitators (ESP) or fabric filters. Either hot-side or cold-side ESPs or fabric filters are installed on all U.S. PC plants and routinely achieve >99% particulate removal. The level of control is affected by coal type, sulfur content, and ash properties. Greater particulate control is possible with enhanced performance units or with the addition of wet ESP after FGD [8] (b above). Wet ESP is beginning to be added to new coal units to control condensable PM and to further reduce particulates. Option b) should achieve less than 0.005 lb PM/million Btu or less than 5 mg/Nm<sup>3</sup> at 6% O<sub>2</sub>, which is what new units in Japan are achieving [9]. Typical PM emission from modern, efficient, U.S. PC units is less than ~0.015 lb/million Btu or less than 15 mg/Nm<sup>3</sup>. CFB units are permitted at slightly higher levels.

ESP capital costs range from \$30 to \$80/kW<sub>e</sub>. Standard ESP costs are at the lower end of this range; retrofits, or a combina-

**Figure A-3.D.1 Achieved and Projected SO<sub>2</sub> and NO<sub>x</sub> Emissions Reductions and Growth in U.S. Electricity Generation**

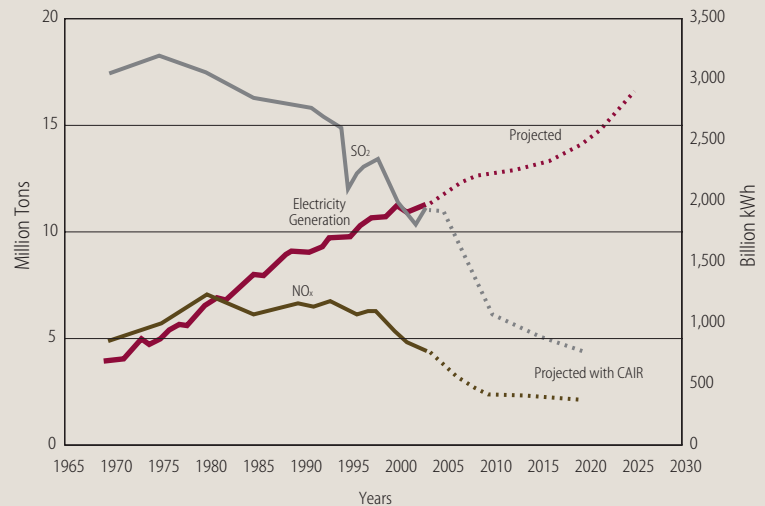

**Table A-3.D.1 NO<sub>x</sub> and SO<sub>2</sub> Caps for CAIR Region and National Mercury Targets under CAMR**

	2009	2010	2015	2018
NO <sub>x</sub> [million tons] CAIR Region	1.5	1.5	1.3	1.3
SO <sub>2</sub> [million tons] CAIR Region	—	3.6	2.5	2.5
Mercury [tons]	—	38	38	15

**Table A-3.D.2 Projected Emissions from Fossil Fuel Based Electric Generators\***

		2003	2009	2015	2020
NO <sub>x</sub> Emissions without CAIR (million tons)	CAIR Region	3.2	2.7	2.8	2.8
	Nationwide	4.2	3.6	3.7	3.7
NO <sub>x</sub> Emissions with CAIR (million tons)	CAIR Region	—	1.5	1.3	1.3
	Nationwide	—	2.4	2.2	2.2
SO <sub>x</sub> Emissions without CAIR (million tons)	CAIR Region	9.4	8.8	8.0	7.7
	Nationwide	10.6	9.7	8.9	8.6
SO <sub>x</sub> Emissions with CAIR (million tons)	CAIR Region	—	5.1	4.0	3.3
	Nationwide	—	6.1	5.0	4.3
Mercury Emissions Nationwide (tons)	Without CAIR and CAMR	48	46.6	45	46.2
	With CAIR	—	38.0	34.4	34.0
	With CAIR and CAMR	—	31.1	27.9	24.3

\* Fossil fuel generators greater than 25 MW that sell one-third or more of their generated electricity to the grid.

**Figure A-3.D.2 Emissions Control Options For Coal-Fired Power Generation**

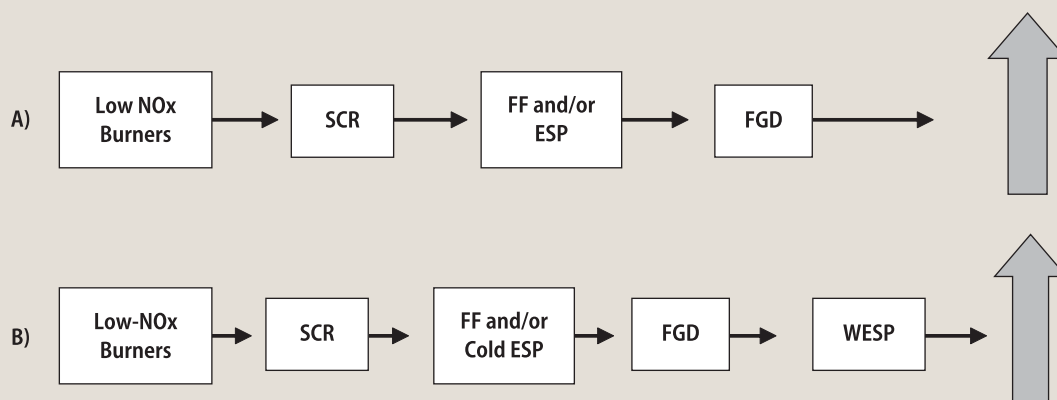

tion of dry ESP and wet ESP ( $\sim \$40/\text{kW}_e$ ) are at the upper end of this range. Operating costs are 0.15 to 0.3 cents/ $\text{kW}_e\text{-h}$  [8]. Achieving efficiencies of about 99.8% could increase the capital by \$5 to  $\$20/\text{kW}_e$  [10]. If a wet ESP is required to achieve these or higher levels of PM emissions reductions, the cost would be appropriately higher. Since an ESP is standard on all PC units, it is typically considered part of the base system cost. The coal ash contained in flue gas is removed as fly ash, which should be disposed of safely to prevent toxic metals from leaching at the disposal site and returning to the environment.

**SO<sub>x</sub> CONTROL** Partial flue gas desulfurization (FGD) can be accomplished by dry injection of limestone into the duct work just behind the air preheater (50-70% removal), with recovery of the solids in the ESP. For fluidized-bed combustion units, the fluidized-bed is primarily limestone, which directly captures most of the SO<sub>x</sub> formed. On PC units wet flue gas desulfurization (FGD) (wet lime scrubbing), can achieve 95% SO<sub>x</sub> removal without additives and 99+% SO<sub>x</sub> removal with additives [8, 11]. Wet FGD has the greatest share of the market in the U.S. (when applied), is proven technology, and is commercially well established. The capital cost for wet scrubbers is from \$100 to  $\$200/\text{kW}_e$ , and the parasitic power for operation is from 1.0 to 3.0% depending on coal sulfur level and removal level. Operating costs are from 0.20 to 0.30  $\text{¢}/\text{kW}_e\text{-h}$ , dependent on sulfur level.

Typical U. S. PC unit commercial emissions performance is 0.21 to 0.23 lb SO<sub>2</sub>/million Btu [12], which meets the level to which these units were permitted. Recently permitted units have lower limits, ranging from 0.08 to about 0.12 lb SO<sub>2</sub>/million Btu for low-sulfur coal to 0.15 to 0.20 lb SO<sub>2</sub>/million Btu for high-sulfur coal. Lower emissions levels can be expected as permit levels are further reduced. FGD technology has not reached its limit of control and can be expected to improve further. Figure A-3.D.3 shows the twenty lowest SO<sub>x</sub> emitting coal-fired PC units in the U. S. as reported in the EPA CEMS Database [13]. Coal sulfur level impacts the SO<sub>x</sub> emissions level achievable.

The best PC unit in the U.S. burning high-sulfur coal, such as Illinois #6, in 2005 had demonstrated emissions performance of 0.074 lb SO<sub>2</sub>/million Btu [11]. For low-sulfur coals, the best performance was 0.03 lb SO<sub>2</sub>/million Btu. The best units in Japan operate below 0.10 lb SO<sub>2</sub>/million Btu [9]. The design developed for the PC units in this report achieved greater than 99% sulfur removal and had an emissions level of about 0.06 lb SO<sub>2</sub>/million Btu, independent of generating efficiency [14]. Emissions per  $\text{MW}_e\text{-h}$  decrease with increasing unit generating efficiency. The wet sludge from the FGD unit should be disposed of safely and

**Figure A-3.D.3 Demonstrated SO<sub>2</sub> Emissions from the 20 Lowest Emitting U. S. Pulverized Coal Power Plants in 2005**

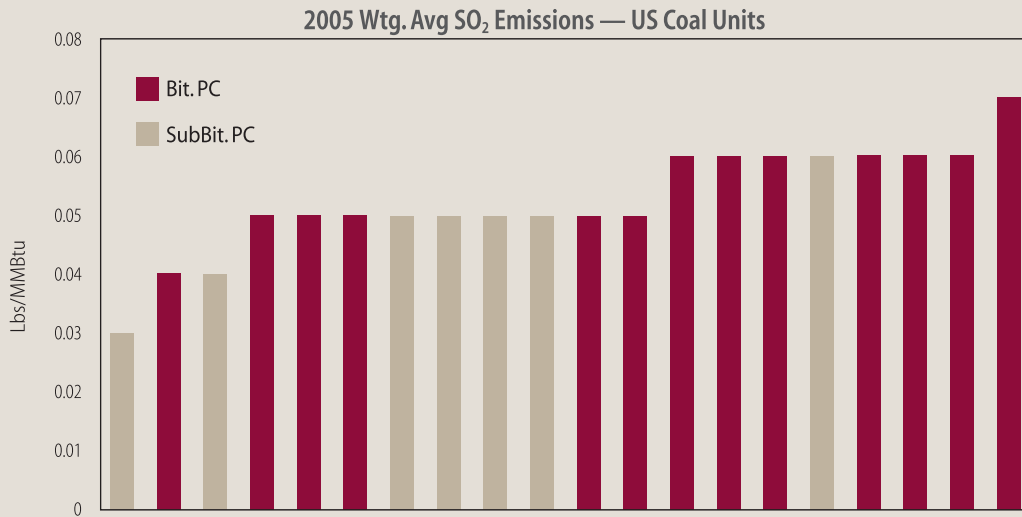

in a manner that does not reintroduce the toxic materials such as mercury and other toxic metals back into the environment.

**NO<sub>x</sub> CONTROL** Low-NO<sub>x</sub> combustion technologies, which are very low cost, are always applied and achieve up to a 50% reduction in NO<sub>x</sub> emissions compared to uncontrolled combustion. The most effective, but also, the most expensive, technology is Selective Catalytic Reduction (SCR), which can achieve 90% NO<sub>x</sub> reduction over inlet concentration. Selective non-catalytic reduction falls between these two in effectiveness and cost. Today, SCR is the technology of choice to meet very low NO<sub>x</sub> levels. Capital cost for SCR is about \$20 to \$40/kW<sub>e</sub> for installation in a typical new unit. For a retrofit the capital cost ranges from \$50 to \$90/kW<sub>e</sub>. Operating cost is in the range of 0.05 to 0.15 cents/kW<sub>e</sub>-h [8, 15].

Typical U.S. PC unit commercial emissions performance is 0.09 lb NO<sub>x</sub>/million Btu to 0.13 lb NO<sub>x</sub>/million Btu, which meets their permit levels. Figure A-3.D.4 shows the NO<sub>x</sub> emissions performance of the 20 lowest NO<sub>x</sub> emitting PC power plants in the U. S. in 2005 [16]. Again the level of NO<sub>x</sub> reduction depends on coal sulfur level.

Recently permitted U.S. units are in the range of 0.07 to 0.12 lb NO<sub>x</sub> /million Btu. The best PC units in the U.S. are achieving demonstrated performance of about 0.04 lbs NO<sub>x</sub>/million Btu on sub-bituminous coal, and about 0.065 lb NO<sub>x</sub>/million Btu on high-sulfur (3.3%) bituminous coal. The Parish plant, burning Powder River Basin coal, is achieving 0.03 lbs NO<sub>x</sub>/million Btu [11]. The best PC units in Japan are achieving somewhat higher NO<sub>x</sub> emissions levels. The design developed for the PC units in this report achieved 0.05 lb NO<sub>x</sub>/million Btu [17].

**MERCURY CONTROL** Mercury in the flue gas is in the elemental and oxidized forms, both in the vapor, and as mercury that has reacted with the fly ash. This third form is removed with the fly ash, resulting in 10 to 30% removal for bituminous coals but less than 10% for sub-bituminous coals and lignite. The oxidized form of mercury is effectively removed by wet FGD scrubbing, resulting in 40-60% total mercury removal for bituminous coals and less than 30–40% total mercury removal for sub-bituminous coals and lignite. For low-sul-

**Figure A-3.D.4 Demonstrated NO<sub>x</sub> Emissions from the 20 Lowest Emitting U. S. Pulverized Coal Plants in 2005**

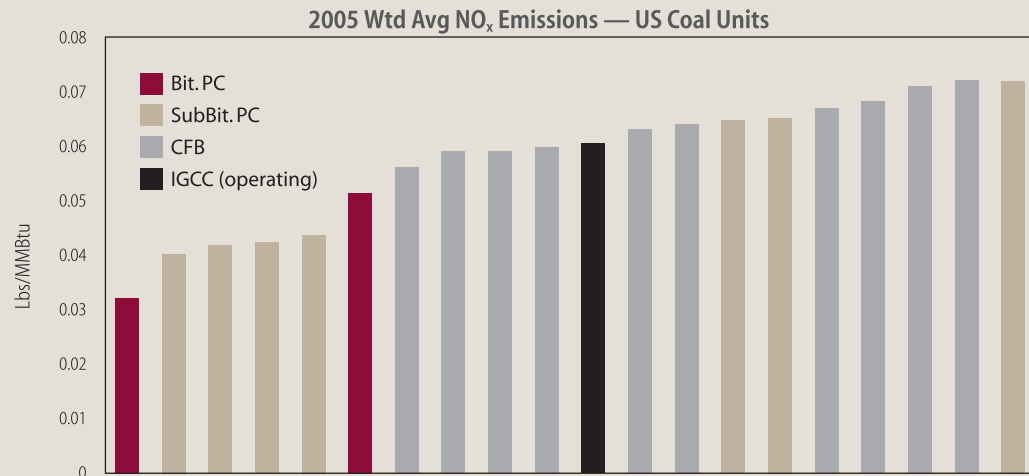

for sub-bituminous coals and particularly lignite, most of the mercury is in the elemental form, which is not removed by wet FGD scrubbing. In most tests of bituminous coals, SCR, for NO<sub>x</sub> control converted 85-95% of the elemental mercury to the oxidized form, which is then removed by FGD [18, 19]. With sub-bituminous coals, the amount of oxidized mercury remained low even with addition of an SCR. Additional mercury removal can be achieved by activated carbon injection and an added fiber filter to collect the carbon. This can achieve up to 85-95% removal of the mercury. Commercial short-duration tests with powdered, activated carbon injection have shown removal rates around 90% for bituminous coals but lower for sub-bituminous coals [19]. For sub-bituminous coals, the injection of brominated, activated carbon has been shown to be highly effective in emissions tests at 3 plants lasting 10 to 30 days. Brominated, activated carbon in these tests showed the potential to reduce mercury by 90% in conjunction with a CS-ESP [15]. Costs are projected at 0.05 to no more than 0.2 ¢/kW<sub>e</sub>-h (Table A-3.D.4).

R&D programs are evaluating improved technology that is expected to reduce costs and improve effectiveness. The general consensus in the industry is that this picture will change significantly within the next few years. EPA states that they believe that PAC injection and enhanced multi-pollutant controls will be available after 2010 for commercial application on most, if not all, key combinations of coal type and control technology to provide mercury removal levels between 60 and 90%. Optimization of this commercial multi-pollutant control technology in the 2015 timeframe should permit achieving mercury removal levels between 90 and 95% on most if not all coals [15], but the technology remains to be commercially demonstrated.

**SOLID WASTE MANAGEMENT** Coal combustion waste consists primarily of fly ash, along with boiler bottom ash, scrubber sludge, and various liquid wastes. This waste contains such contaminants as arsenic, mercury, chromium, lead, selenium, cadmium, and boron. These toxic contaminants can leach from the waste into groundwater and surface water when the waste is not properly disposed. There are no federal regulations governing the disposal of coal combustion waste, and state regulation of the waste is inconsistent or non-existent. The U.S. EPA determined in 2000 [20] that federal regulation of coal combustion wastes was necessary to protect water resources but has not yet promulgated such regulations. Safe dis-

posal of coal combustion waste requires placement in an engineered landfill with sufficient safeguards, including a liner, leachate collection system, groundwater monitoring system and adequate daily cover.

**COSTS** The estimated costs for a supercritical PC power plant to meet today's best demonstrated emissions performance and the projected impact on the COE are summarized in Table A-3.D.3 and Table A-3.D.4.

To meet future CAIR and CAMR emissions targets, and driven by local air quality needs to meet NAAQS and/or other local specifications, power plants will have to add or improve their pollution control capabilities. This will increase the capital as well as the O&M costs for new and existing power plants. Table A-3.D.4 summarizes the estimated incremental costs to meet CAIR and CAMR requirements [21, 22]. This includes estimated increased capital and operating costs for mercury control and for decreasing the PM, SO<sub>x</sub> and NO<sub>x</sub> emissions levels by about a factor of two from current best demonstrated emissions performance levels. This increases the projected COE by about 0.22 ¢/kW<sub>e</sub>-h. If wet ESP is required, this could add approximately 0.1 ¢/kW<sub>e</sub>-h to this amount.

## EMISSIONS CONTROL FOR IGCC

IGCC has inherent advantages for emissions control because most clean-up occurs in the syngas which is contained at high pressure, and contaminants have high partial pressures. Thus, removal can be more effective and economical than cleaning up large volumes of low-pressure flue gas.

**PARTICULATE CONTROL** The coal ash is primarily converted to a fused slag which is about 50% less in volume and is less leachable compared to fly ash, and as such can be more easily disposed of safely. Particulate emissions from existing IGCC units vary from 0.4 to 0.01 lb PM/million Btu. Most of these emissions come from the cooling towers and not from the turbine exhaust and as such are characteristic of any generating unit with large cooling towers. This means that particulate emissions in the stack gas are below 0.001 lb PM/million Btu or about 1 mg/Nm<sup>3</sup>.

**Table A-3.D.3. Incremental Costs for Advanced Pulverized Coal Power Plant to Meet Today's Best Demonstrated Criteria Emissions Performance**

	CAPITAL COST <sup>a</sup> [\$/kW <sub>e</sub> ]	O&M <sup>b</sup> [¢/kW <sub>e</sub> -h]	COE [¢/kW <sub>e</sub> -h]
No Control <sup>c</sup>	1155 (TPC)	0.43	4.11
NO <sub>x</sub>	25 (50 – 90) <sup>d</sup>	0.10 (0.05 – 0.15)	0.15 (0.15 – 0.33)
SO <sub>2</sub>	150 (100 – 200) <sup>d</sup>	0.22 (0.20 – 0.30)	0.52 (0.40 – 0.65)
Today's Unit	1330 (TPC)	0.75	4.78

*a. Capital costs are for a new-build plant, except where indicated, and are for a typical plant to meet today's low emissions levels; costs for low heating value coals will be somewhat higher*  
*b. O&M costs are for typical plant meeting today's low emissions levels; costs will be somewhat higher for high sulfur coal and low heating value coals.*  
*c. Particulate control by ESP or fabric filter included in base unit*  
*d. Range is for retrofits and depends on coal type, properties, control level and local factors*

**Table A-3.D.4. Estimated Incremental Costs for an Advanced Pulverized Coal Plant to Meet Future CAIR and CAMR Requirements**

	CAPITAL COST [\$/kW <sub>e</sub> ]	O&M [¢/kW <sub>e</sub> -h]	COE [¢/kW <sub>e</sub> -h]
Today's Best Units	1330 (TPC)	0.75	4.78
NO <sub>x</sub>	5	0.01	0.02
SO <sub>2</sub>	15	0.04	0.07
Mercury <sup>a</sup>	20 (6 – 56) <sup>b</sup>	0.08 (0.05 – 0.1) <sup>b</sup>	0.13 (0.06 – 0.16) <sup>b</sup>
Future Plant <sup>c</sup>	1370 (TPC)	0.89 (0.80 – 0.85)	5.00

*a. Projected costs for commercially demonstrated technology; new and improved technologies are expected to reduce this significantly, but requires demonstration*  
*b. Range in projected cost increase, dependent on technology, coal type, emission level and local conditions*  
*c. If wet ESP is required, added capital and COE increases could be \$40/kW<sub>e</sub> and ~0.1 cent/kW<sub>e</sub>-h.*

**SO<sub>x</sub> CONTROL** Commercial processes such as MDEA and Selexol can remove more than 99% of the sulfur so that the syngas has a concentration of sulfur compounds that is less than 5 ppmv. MDEA can achieve about 99.4% sulfur removal and should produce an emission rate in the range of 0.045 lb SO<sub>2</sub>/million Btu for high-sulfur coal. Selexol can remove more sulfur to about 99.8% of the sulfur and produce an emissions rate of about 0.015 lb SO<sub>2</sub>/million Btu. The Rectisol process, which is more expensive, can remove 99.9% of the sulfur and reduce the emission rate to about 0.006 lb SO<sub>2</sub>/million Btu (less than 0.1 ppmv) [23, 24].

SO<sub>2</sub> emissions of 0.015 lb SO<sub>2</sub>/million Btu (0.15 lb/MW<sub>e</sub>-h) or ~5.7 mg/Nm<sup>3</sup> has been demonstrated at the ELCOGAS IGCC plant in Puertollano, Spain [25] and at the new IGCC plant in Japan. The Polk IGCC is permitted for 97.5% sulfur removal, which is an emissions rate of about 0.08 lb SO<sub>2</sub>/million Btu [26, 27]. Current IGCC permit applications have sulfur emissions rates of between 0.02 and 0.03 lb SO<sub>2</sub>/million Btu [24]. Recovered sulfur can be converted to elemental sulfur or sulfuric acid and sold as by-product.

**NO<sub>x</sub> CONTROL** NO<sub>x</sub> emissions from IGCC are similar to those from a natural gas-fired combined-cycle plant. Dilution of syngas with nitrogen and water is used to reduce flame temperature and to lower NO<sub>x</sub> formation to below 15 ppm, which is about 0.06 lb NO<sub>x</sub>/million Btu. Further reduction to single digit levels can be achieved with SCR, to an estimated 0.01 lb NO<sub>x</sub>/million Btu. NO<sub>x</sub> emissions of about 0.01 lb NO<sub>x</sub>/million Btu or about 4.2 mg/Nm<sup>3</sup> NO<sub>x</sub> (at 15%O<sub>2</sub>) has been demonstrated commercially in the new IGCC unit in Japan, which uses SCR. The Polk IGCC is permitted for 15 ppmv in the stack gas, but is typically achieving 10 ppmv, which is about 0.09 lb NO<sub>x</sub>/million Btu. Current IGCC permit applications are at the 0.06 to 0.09 lb NO<sub>x</sub>/million Btu.

**MERCURY CONTROL** Commercial technology for mercury removal in carbon beds is available. For natural gas processing, 99.9% removal has been demonstrated, as has 95% removal from syngas [25]. Mercury and other toxics which are also captured in both the syngas clean-up system (partial capture) and carbon beds produces a small volume of material, which must be handled as a hazardous waste. It is a small enough volume of material that these wastes could be managed to permanently sequester mercury from the environment. This is not a current regulatory requirement. The cost of mercury removal has been estimated to \$ 3,412/lb for IGCC, which translates into an estimated cost increase for IGCC of 0.025 ¢/kW<sub>e</sub>-h [28].

**SOLID WASTE MANAGEMENT** IGCC process differences result in significantly different solid waste streams than are produced by a PC. For the same coal feed an IGCC produces 40% to 50% less solid waste than a PC. An IGCC plant produces three types of solid waste: a) ash typically as a dense slag, b) elemental sulfur (as a solid or a liquid), and c) small volumes of solid captured by process equipment.

The vitreous slag is dense and ties up most of the toxic components so that they are not easily leachable. However, limited field data on long-term leaching of coal gasification slag show that some leaching of contaminants can occur [29]. Therefore, proper engineering controls should be applied to coal gasification solid residue disposal sites to ensure that ground water concentrations of certain contaminants do not exceed acceptable limits [29].

Sulfur, as H<sub>2</sub>S in the syngas, can be recovered as either elemental sulfur (solid or liquid) or as sulfuric acid which can be sold as a by-product. If IGCC technology is extensively deployed, it is not clear that all the associated elemental sulfur will be able to find a market.

The metallic toxics that are not tied up in the vitreous slag are volatilized into the syngas and are removed as small volumes of waste at various parts of the gas clean-up system, including a carbon bed that will be used for mercury control.

The current legal status of IGCC solid wastes is less clear than is the case for PC solid waste, because the Congressional language exempting coal combustion wastes from RCRA is ambiguous regarding IGCC wastes.

**WATER USAGE** PC and IGCC technologies both use significant quantities of water, and treatment and recycle are increasingly important issues. IGCC uses 20 to 35% less water than supercritical PC plants [30]. Proven wastewater treatment technology is available and has been demonstrated to handle the water effluents for both technologies.

Table A-3.D.5 compares the estimated incremental cost for a PC plant and for an IGCC plant, to comply with projected future emission caps, built off the base of this report. The incremental difference between IGCC-Future and IGCC-Today is primarily due to the cost of additional mercury removal capabilities [30]. Other emissions are already within the range expected for future control. These estimates are based on reasonable further reductions in emissions using existing technologies with limited learning curves for the PC technology and for IGCC. Moving new PC units to lower emission levels that are consistent with the Federal standards projected through 2015-2018 (mainly mercury with some further SO<sub>x</sub> and NO<sub>x</sub> reductions) does not make PC COE as costly as the COE from IGCC.

**Table A-3.D.5 Estimated Incremental Cost for Pulverized Coal and IGCC to Meet Projected Future Emissions Requirements**

	CAPITAL COST [\$/kW <sub>e</sub> ]	O&M [¢/kW <sub>e</sub> -h]	COE [¢/kW <sub>e</sub> -h]
Advanced PC	1330 (TPC)	0.75	4.78
Future PC	1370 (TPC)	0.89	5.00
IGCC-Today	1429 (TPC)	0.90	5.13
IGCC-Future	1440 (TPC)	0.92	5.16

Although an IGCC can achieve significantly lower emissions than the projected PC levels, there will be an added cost to do so. For example, changing from Selexol to Rectisol involves an increase in capital and operating costs, which could make the cost of removal of the incremental tonnes of SO<sub>2</sub> (\$/tonne) much higher [24] than the allowance costs for SO<sub>2</sub>, which have recently been less than \$1000/tonne. This would eliminate the economic incentive to design units for the extremely low levels that IGCC can achieve. Permitting a unit in an attainment area does not require such heroic efforts, but non-attainment areas may present a different opportunity for IGCC. There is neither sufficient design data nor commercial operating information available to quantitatively assess this situation today.

## CITATIONS AND NOTES

1. EPRI. *Power Plants and Particulate Matter: Formation and Direct Emissions*. Environmental Issues 2005 February 2005 [cited September 18, 2005]; Available from: <http://www.epriweb.com/public/000000000001011505.pdf>.
2. EPA. *Acid Rain Program Laws & Regulations, Title IV*. 2002 October 25, 2002 [cited November 2, 2005]; Available from: <http://www.epa.gov/airmarkets/arp/regs/index.html>.
3. EPA. *CAIR Caps*. 2005 [cited; Available from: [http://www.epa.gov/cair/charts\\_files/cair\\_emissions\\_costs.pdf](http://www.epa.gov/cair/charts_files/cair_emissions_costs.pdf)].
4. EIA, *Annual Energy Outlook 2005*, EIA, Editor. 2005a, U.S. DOE.
5. EPA. *National NO<sub>x</sub> and SO<sub>2</sub> Emissions*. Airtrends 2005 [cited September 23, 2005]; Available from: <http://www.epa.gov/airtrends/2005/pdfs/detailedtable.xls>.
6. EPA, *Regulatory Impact Analysis of the Final Clean Air Mercury Rule*, U.S. EPA, Editor. 2005, EPA.
7. EPA. *Controlling Power Plant Emissions: Overview*. Mercury 2005 [cited September 20, 2005]; Available from: [http://www.epa.gov/mercury/control\\_emissions/](http://www.epa.gov/mercury/control_emissions/).
8. Oskarsson, K., Anders Berglund, Rolf Deling, Ulrika Snellman, Olle Stenback, and Jack Fritz, *A Planner's Guide for Selecting Clean-Coal Technologies for Power Plants*, in *World Bank Technical Paper No. 387*, W. Bank, Editor. 1997, World Bank: Washington.
9. PowerClean, T.N., *Fossil Fuel Power Generation State-of-the-Art*, P.T. Network, Editor. 2004, University of Ulster: Coleraine, UK. p. 9-10.
10. Tavoulares, E.S., and J. P. Charpentier, *Clean Coal Technologies for Developing Countries*, in *World Bank Technical Paper No. 286*. 1995, World Bank: Washington, DC.
11. Alstom, *Emissions Performance of PC Units*, Personal Communication. 2005: Windsor, Connecticut.
12. When input based standards are given such as lb/ MMBtu are, mg/Nm<sup>3</sup>, or ppmv are compared, the respective degree of dilution of the flue gas needs to be specified in terms of flue gas O<sub>2</sub> concentration. All values here are given for 6% O<sub>2</sub> which is the international standard; boiler emission standards in the U.S. are typically given for 3% O<sub>2</sub>.
13. USEPA, *Continuous Emissions Monitoring System (CEMS) Data Base of 2005 Power Plant Emissions Data*. 2005, EPA.
14. For IGCC units, the capital and operating costs were assumed to be for the nth plant, where n was a small number such as 5-6. For the PC plant emissions control, performance was assumed to be characteristic of that expected with a similar learning curve for advancing emissions control technology, all in \$2005.
15. Chaisson, J., *EPA Flue Gas Emission Control Cost Information*. 2005.
16. CEMS, E., *Energy Velocity Database*. 2005, EPA.
17. See note 14.
18. *Testimony on S556, Clean Power Act 2001*, in *Committee on Environmental and Public Works of the U.S. Senate*. 2002: Washington, DC.
19. EPA, *Control of Mercury Emissions from Coal Fired Electric Utility Boilers: An Update*. 2005, Air Pollution Prevention and Control, U.S. EPA: Research Triangle Park, NC.
20. Federal-Register, *Final Rule, Regulatory Determination on Wastes from the Combustion of Fossil Fuels*. 2000, U. S. Government. p. 32213.
21. NCC, *Opportunities to Expedite the Construction of New Coal-Based Power Plants*. 2004, National Coal Council.
22. Brown, T., W. O'Dowd, R. Reuther, and D. Smith, *Control of Mercury from Coal-Fired Power Plants: a Preliminary Cost Assessment*. 2004, U.S. DOE, Federal Energy Technology Center.
23. Korens, N., *Process Screening Analysis of Alternative Gas Treating and Sulfur Removal for Gasification*. 2002, DOE/ NETL: Pittsburgh.
24. Kentuckiana\_Engin\_Co., *Prevention of Significant Deterioration Construction Permit Application*. 2006, Kentuckiana Engineering Company, Inc.: Louisville. p. 4-1 to 1-70.
25. Thompson, J., *Integrated Gasification Combined Cycle (IGCC) - Environmental Performance*, in *Platts IGCC Symposium*. 2005: Pittsburgh.
26. DOE, *Tampa Electric Polk Power Station Integrated Gasification Combined Cycle Project*. 2002, U.S. DOE: Morgantown, WV.
27. ICAC, *Institute of Clean Air Companies*, D. Foerter, Editor. 2005: Washington, DC.
28. Parsons, *The Cost of Mercury Removal in an IGCC Plant*, P.I.a.T. Group, Editor. 2002.
29. EPRI, *Long-term Leaching Tests with Coal Gasification Slag*, in *GS-6439*. 1989, Electric Power Research Institute: Palo Alto.
30. Rutkowski, M.D., M.G. Klett, and R.C. Maxwell, *The Cost of Mercury Removal in an IGCC Plant*, in *2002 Parsons*. 2002.



## Appendix 3.E — Retrofitting Existing Units for CO<sub>2</sub> Capture

The U.S. coal-based generating capacity is about 330 GW, which is 33% of the total, but because it is primarily base load, it generated 51% of the electricity produced in the U.S. (1980 TW<sub>e</sub>-h) in 2003. Although the average age of the coal fleet is greater than 35 years (number average age), 50% of the coal is consumed in units that are less than 30 years old [1, 2]. Of the over 1000 boilers in the U.S. about 100 are supercritical, the remainder being subcritical units. There are currently over 100 coal-based power plants at various stages of consideration/approval in the U.S. of which about 20 GW of new coal based capacity are expected to be built by 2015. Of these new units, a significant fraction will be supercritical units.

The issue of what to do with this coal fleet base in a carbon-constrained environment is critical if the U.S. is to manage its CO<sub>2</sub> emissions from coal generation. The options include: (a) substantially improve unit generating efficiency, (b) continue to operate them and achieve additional carbon reductions from other areas, (c) retire and replace the units with new capacity equipped with carbon capture for sequestration, (d) retrofit existing units to capture CO<sub>2</sub> for sequestration, or (e) operate the units and pay the carbon tax. Here we consider the issues associated with retrofitting existing coal-fired generating units for CO<sub>2</sub> capture.

Adding CO<sub>2</sub> capture technology to an existing PC unit is complicated by the range of options that exist and the number of issues associated with each. These can typically not be generalized because they are determined by the specific details of each unit. The physical issues include space constraints associated with the unit, and its proximity to a CO<sub>2</sub> sequestration site. The technical issues include: technology choice, technology maturity, operability and reliability, impact on efficiency, and retrofit complexity. The economic issues are the investment required (total and \$/kW<sub>e</sub>), net output reduction, and change in dispatch order.

A decision tree illustrating a number of the options that need to be considered is shown in Figure A-3.E.1. These include a standard retrofit of the existing unit to capture CO<sub>2</sub> either

**Figure A-3.E.1 Decision Tree of Possible First-Level Options for Retrofitting an Existing Subcritical Pulverized Coal Electricity Generating Unit**

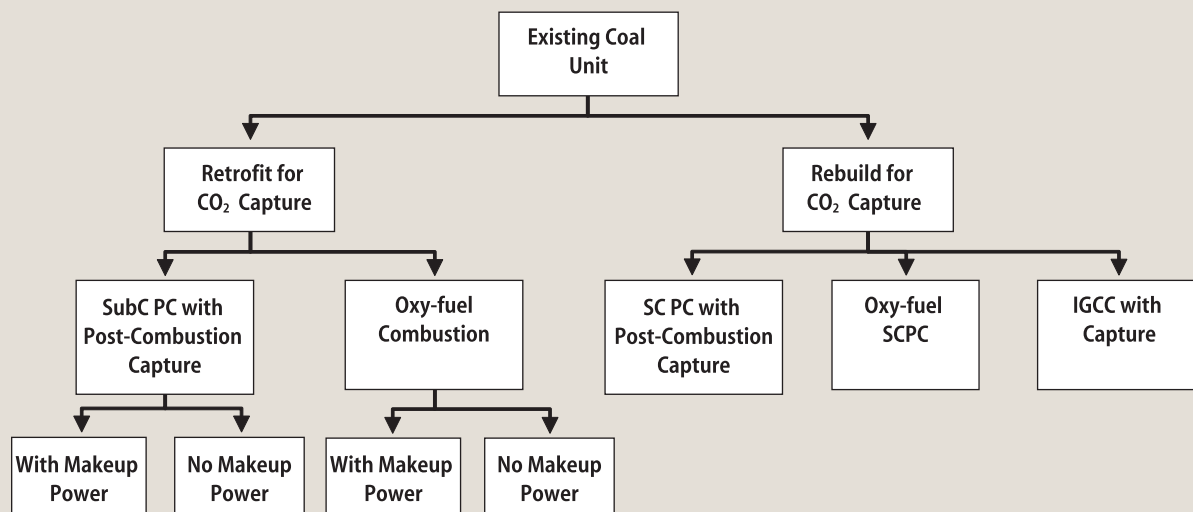

by post-combustion capture with one of several technologies or by addition of oxy-fuel combustion with CO<sub>2</sub> capture by compression. Because of the derating that occurs upon adding capture technology, additional capital can be spent to make up for the lost power by adding an additional boiler with each of the options.

A more aggressive approach would be to rebuild the existing unit to include CO<sub>2</sub> capture and improve the overall technology on the site, resulting in an optimally sized and balanced unit. This could be done by upgrading to a supercritical PC or an ultra-supercritical PC with post-combustion CO<sub>2</sub> capture, by upgrading to oxy-fuel supercritical technology, or by installing IGCC with CO<sub>2</sub> capture.

### RETROFIT AND REBUILD FOR CO<sub>2</sub> CAPTURE FOR PULVERIZED COAL UNITS

Recent studies by Alstom Power, Inc. [3, 4] and by Simbeck [5, 6]) provide a basis for estimating the economics of retrofitting and rebuilding existing units for CO<sub>2</sub> capture. These studies involved subcritical boilers only. The base unit size was 500 MW<sub>e</sub> for the Alstom evaluation and 300 MW<sub>e</sub> for Simbeck.

**EFFICIENCY AND NET OUTPUT** The impact on net electrical output and unit efficiency of retrofitting a subcritical PC unit for CO<sub>2</sub> capture by adding amine adsorption and by adding oxy-firing is shown in Figure A-3.E.2. Cases involving rebuilds of key components were also evaluated by Simbeck [5].

**Figure A-3.E.2 Impact of Retrofitting or Rebuilding a Subcritical Pulverized Coal Unit**

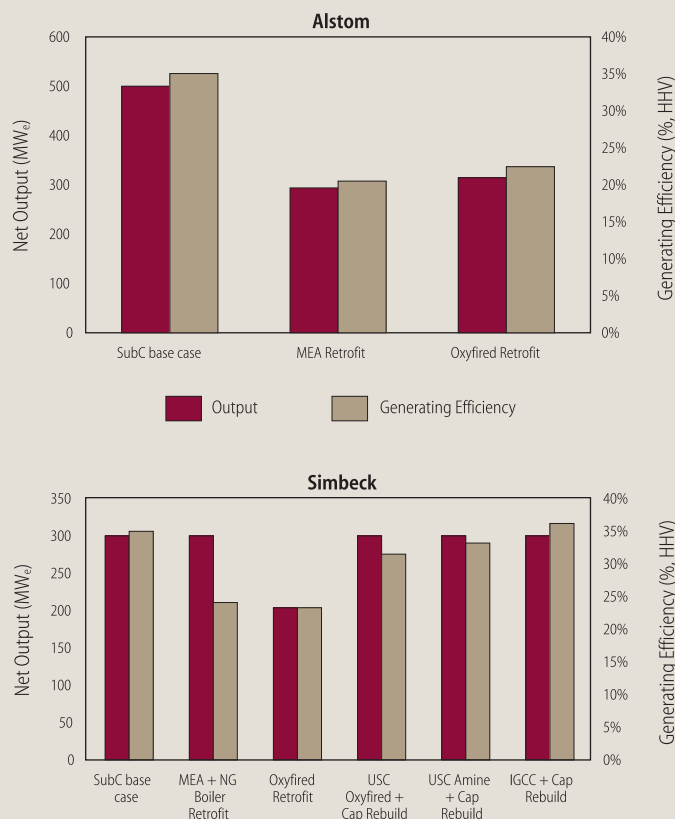

Adding MEA (monoethanolamine) flue gas scrubbing to the unit decreased the net generating capacity from 500 MW<sub>e</sub> to 294 MW<sub>e</sub>, a 41% derating. For this retrofit, the reduction in efficiency is from 35% to 20.5% (HHV), or 14.5 percentage points. The efficiency reduction for purpose-built units from this study in going from no-capture to capture is 34.3% to 25.1% (HHV) or 9.2 percentage points (Figure 3.5). The roughly additional 5 percentage point efficiency reduction is due to the non-optimum size mismatch of the components in the retrofit case.

For an oxy-fuel retrofit the net output is derated by 35.9% (500 MW<sub>e</sub> to 315 MW<sub>e</sub>) [3] and 33.3% (300 MW<sub>e</sub> to 204 MW<sub>e</sub>) [5] (Figure A-3.E.2). This corresponds to efficiencies of 22.5% and 23.3% (HHV) respectively. These are efficiency reductions of 12.5 and 11.7 percentage points, vs. an 8 to 9 percentage point reduction estimated for a purpose-built oxy-fuel PC unit.

We estimated the capital costs, and the impacts on performance and COE of retrofitting a supercritical PC unit based on information from the subcritical PC evaluations and our greenfield supercritical unit information. An amine scrubbing retrofit of a

**Table A-3.E.1 Summary of Greenfield and Retrofit Efficiencies and Deratings for Pulverized Coal Units**

TECHNOLOGY	GREENFIELD SUBC PC	GREENFIELD SC PC	RETROFIT SUBC PC	RETROFIT SC PC
Baseline Efficiency (% HHV)	35.0	39.2	35.0	39.2
MEA Derating (%)	28.1	25.2	41.5	36
MEA Efficiency (% HHV)	25.1	29.3	20.5	25
Oxy-fuel Derating (%)	n/a	23.0	35.9	31
Oxy-fuel Efficiency (% HHV)	n/a	30.2	22.4	27

supercritical PC (39.2% efficiency (HHV)) reduces the efficiency by about 36% (to 25% (HHV)), vs. a 41% derating for the subcritical unit retrofit due to the higher initial efficiency of the supercritical base unit. The net power output is 320 MW<sub>e</sub>, a 36% derating. Oxy-fuel retrofit reduces the efficiency to about 27% vs. 30.2% (HHV) for a purpose-built oxy-fuel supercritical PC unit. Table A-3.E.1 summarizes the results for subcritical and supercritical PC retrofits.

Simbeck [5] also evaluated rebuild cases designed to maintain the same electrical output as the base case and also to upgrade the unit with an ultra-supercritical steam cycle. The USCPC rebuild unit with MEA CO<sub>2</sub> capture had a generating efficiency that was only 3.5 percentage points below the subcritical base case unit without CO<sub>2</sub> capture. An ultra-supercritical oxy-fuel rebuild for CO<sub>2</sub> capture had a generating efficiency only 1.8 percentage points lower than the subcritical base case without CO<sub>2</sub> capture. Rebuilding with an IGCC unit with CO<sub>2</sub> capture resulted in a generating efficiency that was 1.2 percentage points higher than the original base case subcritical unit without CO<sub>2</sub> capture. The rebuild efficiencies are similar to those for new, purpose-built USC capture units. This is as expected because rebuilding a unit allows the optimum sizing of major pieces of equipment.

**CAPITAL COSTS** The capital cost associated with these retrofits/rebuilds varies significantly, depending on the approach taken. Figure A-3.E.3 summarizes the incremental capital costs, in \$/kW<sub>e</sub>, for each of the cases. The subcritical PC base case unit was assumed to be fully paid off and thus to have zero value. The capital cost for the supercritical retrofits was scaled from the subcritical cases based on the increased efficiency and reduced CO<sub>2</sub> production per kW<sub>e</sub>-h output.

The capital cost per net kW<sub>e</sub> output for the straight MEA retrofit [3] is high (\$1604/kW<sub>e</sub>) because of the severe output reduction that occurs. If a simple natural gas boiler is added to the MEA retrofit to provide make-up stripping steam for CO<sub>2</sub> recovery so that net electrical output is not reduced [5], the cost is lowered to \$800/kW<sub>e</sub>. The oxy-fuel retrofit cost for the two studies is similar (\$1044/kW<sub>e</sub> [3] and 1060/kW<sub>e</sub> [5]) and is

**Figure A-3.E.3 Capital Cost for Subcritical Pulverized Coal Retrofits and Rebuilds**

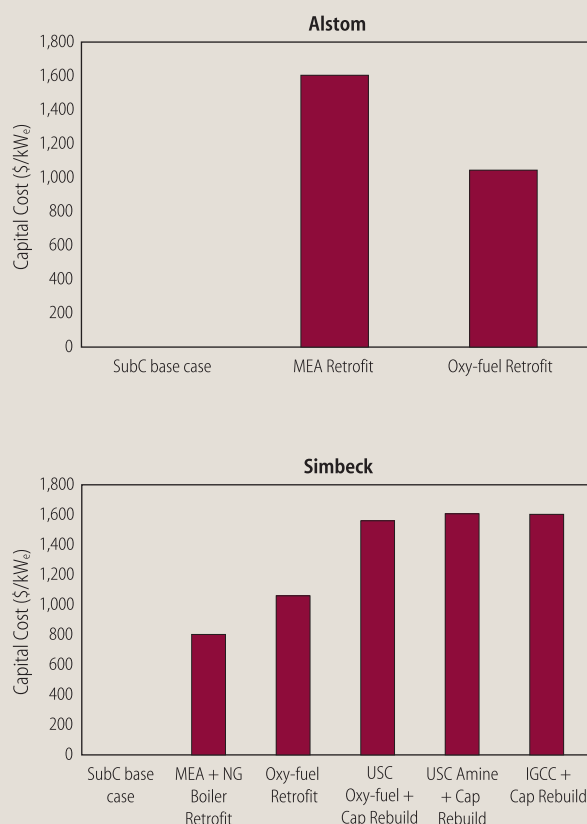

significantly lower than the other options evaluated. The rebuild cases each have a capital cost in the range of \$1550 to \$1600/kW<sub>e</sub>.

**COST OF ELECTRICITY** To calculate the COE for these cases, we applied the same normalization parameters that were used in analyzing new generating units (Table 3.4, summarized in Table A-3.E.2). A key assumption in this analysis is that the existing units are fully paid off and thus carry no capital charge other than the added retrofit or rebuilding capital. The results of this analysis are presented in Figure A-3.E.4 For details see [7].

**Table A-3.E.2 Economic and Operational Normalization Parameters**

PARAMETER	VALUE
Annual carrying charge rate (applied to TPC)	15.1%
Capacity factor	85%
Fuel cost, coal (\$/MMBtu, (HHV))	\$1.50
Fuel cost, natural gas (\$/MMBtu, (HHV))	\$9.00

**Figure A-3.E.4 Incremental, Total and Marginal Cost of Electricity for Subcritical Pulverized Coal Unit Retrofits and Rebuilds**

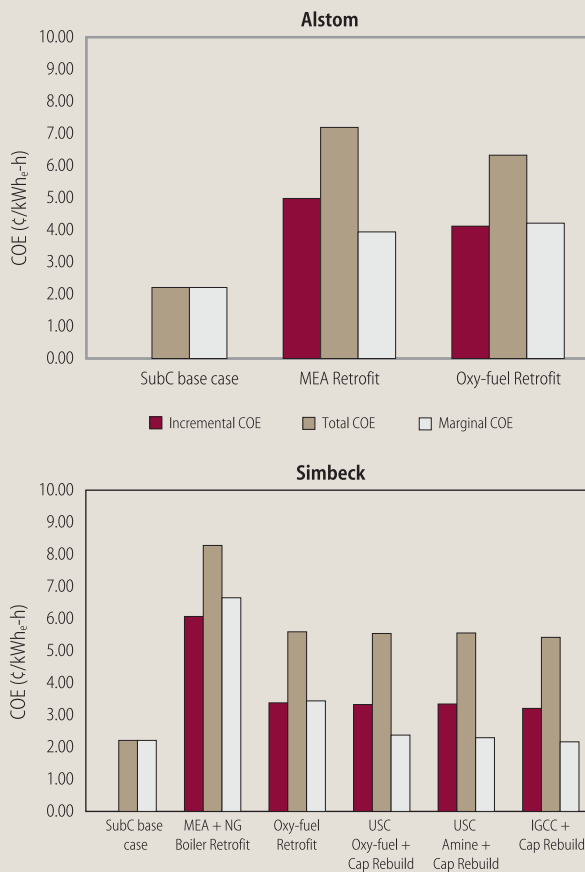

For the retrofit options, oxy-fuel is the most attractive because it has lower total and incremental COE costs than the MEA retrofit and similar marginal COE costs. It is slightly more costly than the rebuild cases. The MEA retrofit with the natural gas boiler is the least attractive of all the retrofit cases based on total, incremental and marginal COE costs. The primary cause of this is the significant natural gas input requirement, which significantly increases the fuel cost component of COE. Compared with the oxy-fuel retrofit, the rebuild options have lower marginal COE and similar incremental and total COE costs. If natural gas is assumed to be \$6.00 per million Btu, these conclusions do not change, although the Total, Incremental and Marginal COE for the MEA with natural gas boiler case decrease by 1.3 ¢/kW<sub>e</sub>-h.

**ECONOMICS FOR PC RETROFITS** Table A-3.E.3 summarizes the economics of the primary retrofit and rebuild cases on the same bases as used throughout this report. The O&M costs for the retrofit options were estimated by scaling O&M costs for greenfield capture units by the decreased generating efficiency of the retrofit options.

The CO<sub>2</sub> avoidance and capture costs (in \$/tonne) were calculated for the retrofit and rebuild cases using a CO<sub>2</sub> capture efficiency of 90% for each case. The results of this analysis are presented in Table A-3.E.4 [8].

**IMPACT OF CAPITAL WRITE-OFF ASSUMPTION ON COE** This analysis assumed that the capital associated with the original unit has been fully written off. This may not be the case when retrofits of newer units are considered, or where there is market value for the non-retrofitted unit. To accommodate this factor, a sensitivity to different levels of residual value in the original unit was performed for the two SCPC cases (see Table A-3.E.5).

The assumption of residual value can have a significant impact on the economics of retrofitting, and should be considered in the analysis of retrofit cases, although it may not be a key retrofit determinant because that capital is already sunk.

**Table A-3.E.3 Total Cost of Electricity for Pulverized Coal Retrofit and Rebuild Cases**

TECHNOLOGY	BASELINE CASES		RETROFITS – SUBC PC		RETROFITS – SC PC		REBUILDS – USC PC	
	SUBC PC	SC PC	MEA	OXY-FUEL	MEA	OXY-FUEL	MEA	OXY-FUEL
Efficiency (HHV)	35%	39.2%	20.5%	22.4%	25%	27%	34.1%	31.5%
Retrofit/Rebuild Capital Cost (\$/kW <sub>e</sub> )	0	0	1604	1043	1314	867	1880*	1848*
Capital Cost (¢/kW <sub>e</sub> -h)**	0.00	0.00	3.25	2.12	2.66	1.76	3.81	3.75
O&M (¢/kW <sub>e</sub> -h)	0.75	0.75	1.96	2.36	1.88	1.96	1.60	1.75
Fuel Cost (¢/kW <sub>e</sub> -h)	1.46	1.31	2.50	2.29	2.05	1.90	1.50	1.63
Total COE (¢/kW <sub>e</sub> -h)	2.21	2.06	7.71	6.76	6.59	5.61	6.91	7.12

\* Assumes capital required was 90% of that of the corresponding Greenfield plant

\*\* Calculation of total COE assumes that the capital of the original plant was fully paid off

**Table A-3.E.4 CO<sub>2</sub> Emission Rates, Capture Cost and Avoidance Costs for Pulverized Coal Cases**

TECHNOLOGY	BASELINE CASES		RETROFITS – SUBC PC		RETROFITS – SC PC		REBUILDS – USC PC	
	SUBC PC	SC PC	MEA	OXY-FUEL	MEA	OXY-FUEL	MEA	OXY-FUEL
CO <sub>2</sub> Produced (tonnes/MW <sub>e</sub> -h)	0.93	0.83	1.59	1.45	1.30	1.20	0.95	1.03
CO <sub>2</sub> Captured (tonnes/MW <sub>e</sub> -h)	0.00	0.00	1.43	1.31	1.17	1.08	0.86	0.93
CO <sub>2</sub> Emitted (tonnes/MW <sub>e</sub> -h)	0.93	0.83	0.16	0.15	0.13	0.12	0.10	0.10
CO <sub>2</sub> Capture cost <sup>a</sup> (\$/tonne)	n/a	n/a	38.5	34.8	38.7	32.8	54.8*	52.9*
CO <sub>2</sub> Avoidance cost <sup>b</sup> (\$/tonne)	n/a	n/a	71.4	58.0	62.6	48.0	56.4*	59.5*

a. CO<sub>2</sub> capture cost = (total COE with capture – base-case total COE)/(captured CO<sub>2</sub>)

b. CO<sub>2</sub> avoidance cost = (total COE with capture – total COE without capture)/(CO<sub>2</sub> emitted without capture – CO<sub>2</sub> emitted with capture)

c. Relative to the SubC PC baseline case

**Table A-3.E.5 Impact of Residual Unit Capital Value on Incremental and Total Cost of Electricity (¢/kW<sub>e</sub>-h)**

REMAINING CAPITAL ASSUMPTION	SC PC WITH MEA RETROFIT (¢/kW <sub>e</sub> -h)	OXY-FUEL SC PC RETROFIT (¢/kW <sub>e</sub> -h)
10%	0.43	0.40
25%	1.07	0.99
50%	2.14	1.98

## RETROFIT OF IGCC FOR CO<sub>2</sub> CAPTURE

Retrofitting IGCC for CO<sub>2</sub> capture involves changes in the core of the gasification/com-bustion/ power generation train that are different from the type of changes that need to be made upon retrofitting a PC unit for capture, i.e., adding a separate unit to the flue-gas train. The choice of gasifier and of gasifier configuration and design are different for an optimum IGCC design without CO<sub>2</sub> capture and an IGCC design with CO<sub>2</sub> capture. The available data contain insufficient design and cost information to quantitatively evaluate most of the options and configurations available.

Designs without CO<sub>2</sub> capture tend to favor lower pressure, 2.8 to 4.2 MPa (400 to 600 psi) and increased heat recovery from the gasifier train, including radiant syngas cooling and convective syngas cooling to raise more steam for the steam turbine and increase the net generating efficiency (See Appendix 3-B, Figure A-3.B.2.). Dry-feed gasifiers, e.g. Shell, provide the highest efficiency and are favored for coals with lower heating values, primarily because of their already-higher moisture content. However, today, such gasifiers have higher capital cost. The higher capital cost charge to COE is partially offset by higher generating efficiency, reduced coal feed rate and cost, and may be totally offset by lower coal cost in the case of low-quality coals.

On the other hand, designs with CO<sub>2</sub> capture favor higher-pressure (1000 psi) operation, slurry-feed, and full-quench mode [9]. Full-quench mode is the most effective method of adding sufficient steam to the raw syngas for the water gas shift reaction without additional, expensive steam raising equipment and/or robbing steam from the steam cycle. Higher pressure reduces the cost of CO<sub>2</sub> capture and recovery, and of CO<sub>2</sub> compression. The following examples illustrate these points and the differences between retrofitting a PC and an IGCC unit.

For a GE full-quench, (1000 psi) design without CO<sub>2</sub> capture, the overall generating efficiency is about 35.5 % [10]. The capital cost for retrofitting this IGCC unit for CO<sub>2</sub> capture was estimated to be about \$180/kW<sub>e</sub> [10], which is significantly lower than that for retrofitting a PC unit on an absolute basis and on a \$/kW<sub>e</sub> basis. This retrofit results in an overall unit derating (efficiency reduction) of about 17 % (see Figure A-3.E.5). Furthermore, the additional derating over a purpose-built IGCC unit with CO<sub>2</sub> capture is projected to be less than 1 percentage point efficiency reduction, vs. the additional 4+ percentage point efficiency reduction estimated for an MEA retrofit of a subcritical PC unit. Thus, the impact on COE is also less.

Figure A-3.E.5 illustrates the impact of the retrofit on the net electrical output. With no increase in coal feed rate, the gas turbine for the capture case is producing 4.9% less power than for the baseline, no CO<sub>2</sub> capture case; and the steam turbine is producing 7.4% less. Thus, these turbines are close to their optimum operating efficiencies. The gas turbine was retrofitted to burn hydrogen-rich syngas at a cost of about \$6 million, which is in the retrofit cost. The reduced net electrical output for the unit is about 17% because the auxiliary power requirements are up considerably in the CO<sub>2</sub> capture case. The overall efficiency decreased from 35.3% to 29.5% upon retrofitting for CO<sub>2</sub> capture.

EPRI also evaluated the impact of pre-investment for CO<sub>2</sub> capture for this case, including over-sizing the gasifier and ASU, and optimizing the unit layout for the addition of CO<sub>2</sub> capture equipment at a later date [10]. Incremental capital required for pre-investment was estimated to be about \$60/kW<sub>e</sub>, which would add about 0.12 ¢/kW<sub>e</sub>-h to the cost of electricity produced by the IGCC unit without CO<sub>2</sub> capture suggesting the preinvestment was not justified [11]. Furthermore, the impact of pre-investment on retrofit cost was relatively small, about 5% less than for a straight retrofit on a \$/kW<sub>e</sub> basis. Pre-investment can effectively eliminate the derating in net unit output upon adding CO<sub>2</sub>-capture capability vs. the output of a purpose-built IGCC unit with CO<sub>2</sub> capture. The study projects that the retrofit unit will produce electricity within 0.15 ¢/kW<sub>e</sub>-h of a purpose-built IGCC capture unit. We therefore expect that the COE will be in line with that in Table 3.5.

**Figure A-3.E.5 Impact of Retrofitting a GE Full-Quench IGCC Unit for CO<sub>2</sub> Capture**

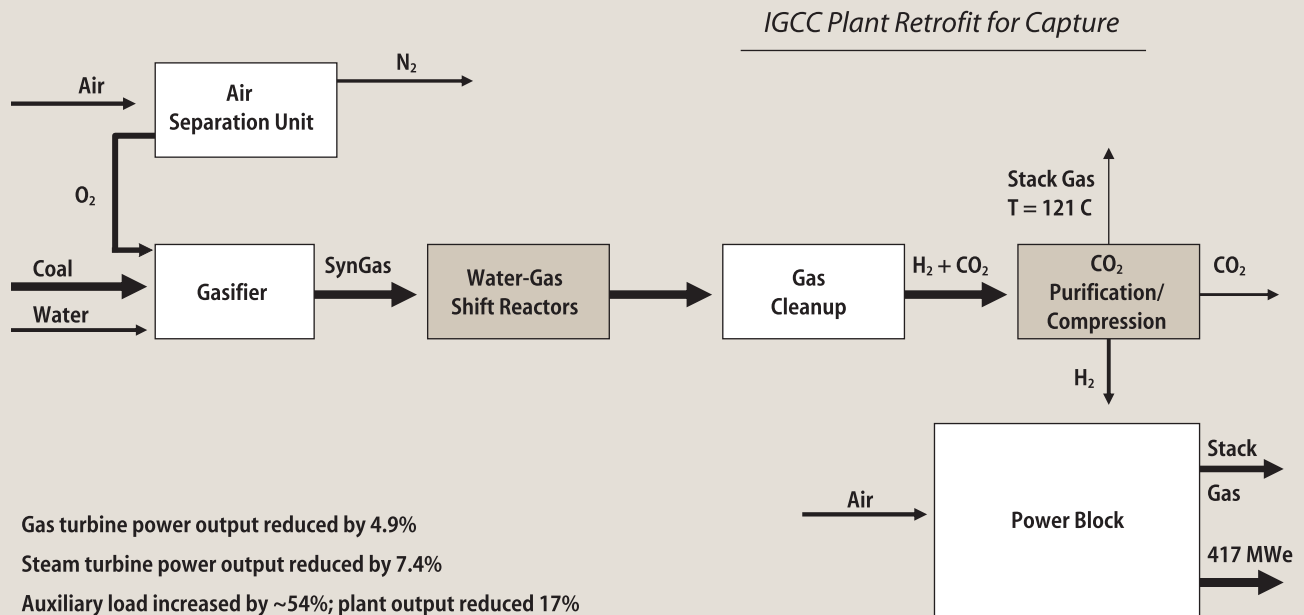

In the case of a lower-pressure E-Gas gasifier-based IGCC unit operating at 3.5 MPa (500 psi) with radiant cooling and convective syngas coolers to maximize the heat recovery and HP steam delivery to the steam turbine, the overall unit generating efficiency without CO<sub>2</sub> capture is 39.5 % [10]. With the addition of CO<sub>2</sub> capture and at constant coal feed rate, the gas turbine undergoes an 8.7 % derating. However, the major impact is on the steam turbine. Because the syngas has a lower water to (CO + H<sub>2</sub>) ratio than for the GE full-quench unit, steam must be added to the gas stream prior to the water gas shift reactors to achieve adequate CO conversion. This steam is taken from the steam turbine system reducing the steam turbine output by 19 %. Total auxiliaries are similar for the two cases. Retrofitting reduced the overall efficiency from 39.5% to 30.5%, a 23% reduction. Lower-pressure operation also contributes to this larger efficiency decrease, through both increased CO<sub>2</sub> separation and compression costs. A unit built with a GE gasifier with radiant and convective syngas coolers would have a similar efficiency reduction upon retrofit.

The retrofit costs were estimated at \$225/kW<sub>e</sub>, significantly greater than for the GE full-quench retrofit because of the need for several additional pieces of equipment beyond the adds and upgrades that are required for both. Overall, the changes were more significant for the E-gas case. Further, the additional heat recovery of the original gasifier design which adds significant cost is not effectively used in the CO<sub>2</sub> capture mode. The optimum design would not contain the same gasifier/heat recovery system for a CO<sub>2</sub> capture unit as for a no-capture unit, and retrofitting a no-capture unit to a CO<sub>2</sub> capture configuration does not involve the optimum use of capital.

### IMPACT OF NEW TECHNOLOGIES ON CAPTURE

The above analyses are based on existing, commercially-demonstrated technologies. As occurred with PC emissions control technologies, such as flue gas desulfurization technology, when commercial application of CO<sub>2</sub> capture becomes relatively close and certain, it can be

expected that new and improved technologies that are both more effective and less expensive for CO<sub>2</sub> capture will evolve and be improved-upon as commercial experience is gained. Thus, although we expect the cost differences discussed above to remain directionally correct, we expect that the deltas could change significantly.

Alternative technologies, in addition to MEA post-combustion capture and oxy-firing are currently being investigated for CO<sub>2</sub> capture from pulverized coal units. These include, among others: chemical looping, CO<sub>2</sub> frosting, CO<sub>2</sub> adsorber wheels, and chilled aqueous ammonia scrubbing[3, 12, 13]. Chapter 6 addresses this area further.

## CITATIONS AND NOTES

1. NETL, *NETL Coal Power Database; Update for 2000 Operations, Technical and Performance Baseline*. 2002, NETL.
2. NETL, *Power Plant Aging Characterization*. 2002.
3. Bozzuto, C.R., N. Nsakala, G. N. Liljedahl, M. Palkes, J.L. Marion, D. Vogel, J. C. Gupta, M. Fugate, and M. K. Guha, *Engineering Feasibility and Economics of CO<sub>2</sub> Capture on an Existing Coal-Fired Power Plant*, NETL, U.S. Department of Energy. 2001, Alstom Power Inc. [Report No. PPL-01-CT-09]
4. Nsakala, N.G., et al., *Engineering Feasibility of CO<sub>2</sub> Capture on an Existing U.S. Coal-Fired Power Plant*, in *First National Conference on Carbon Sequestration*. 2001: Washington, DC.
5. Simbeck, D., *Existing Power Plants — CO<sub>2</sub> Mitigation Costs*, Personal communication to J.R. Katzer. 2005: Cambridge, MA.
6. Simbeck, D., *CO<sub>2</sub> Mitigation Economics for Existing Coal-Fired Power Plants*, in *First National Conference on Carbon Sequestration*. 2001: Washington, DC.
7. For this analysis: (a) the capital of the existing plant is assumed to be entirely written off, (b) marginal COE is defined as the variable cost of production, which consists of fuel cost and variable O&M, (c) Incremental COE is defined as the increase in Total COE for a capture case with respect to the baseline, no-capture plant, and (d) Total COE is defined as the sum of all costs associated with electricity production [fuel cost, capital charge, and all O&M].
8.  $CO_2$  capture cost = (total COE with capture - basecase total COE) / captured CO<sub>2</sub>.  $CO_2$  avoidance cost = (total COE with capture - total COE without capture) / (CO<sub>2</sub> emitted without capture - CO<sub>2</sub> emitted with capture)
9. Holt, N., *Gasification & IGCC - Status, Challenges, Design Issues & Opportunities*, in *Reaction Engineering International*. 2005: Salt Lake City, Utah.
10. EPRI, *EPRI Phased Construction of IGCC Plants*. 2001.
11. Sekar, R.C., J. E. Parsons, H. J. Herzog, and H. D. Jacoby, *Future Carbon Regulations and Current Investments in Alternative Carbon-Fired Power Plant Designs*, in *MIT Global Climate Change Joint Program Publications*. 2005, MIT: Cambridge, MA. p. 19.
12. Ciferno, J.P., P. DiPietro, and T. Tarka, *An Economic Scoping Study for CO<sub>2</sub> Capture using Aqueous Ammonia*, NETL, Editor. 2005.
13. Marion, J., N. Mohn, G. N. Liljedahl, J. X. Morin and P. P. Henriksen, *Technology Options for Controlling CO<sub>2</sub> Emissions from Fossil-Fueled Power Plants*, in *Clearwater Coal Conference*. 2006: Clearwater Florida.



## Appendix 3.F — Coal to Fuels And Chemicals

As the price petroleum and natural gas increases relative to unconventional hydrocarbon resources, there will be increasing interest in exploring the commercial potential of producing synthetic liquid fuels, chemicals, and synthetic natural gas (SNG) from coal and also oil shale. This trend is already apparent in the increasingly large investments to produce and upgrade heavy oils in Venezuela, and oil sands in Canada. If it appears that crude oil and natural gas prices will fluctuate in a range near their recent historically-high values rather than return to previously lower levels, commercial projects to produce synthetic liquids, chemicals, and SNG from coal will receive increasing attention.

Unfortunately, the conversion of coal to synthetic fuels and chemicals requires large energy inputs which in turn result in greater production of CO<sub>2</sub>. The initial step in the production of methane or (SNG), of chemicals, or of liquids, such as methanol, diesel or gasoline, from coal is the gasification of coal to produce syngas, just as carried out in IGCC for electricity generation. This syngas, which is a mixture of predominately carbon monoxide and hydrogen is cleaned of impurities; and the hydrogen to carbon monoxide ratio is increased by the water gas shift reaction to the value required by the specific synthesis reaction to be carried out. After the water gas shift reaction, CO<sub>2</sub> is removed from the synthesis gas. For liquids production, this route is referred to as indirect liquefaction, and this is the route analyzed here.

Coal can also be converted directly to liquid products by reaction at high temperature and high hydrogen pressure. This route is referred to as direct liquefaction. However, the direct liquefaction route is very costly because of severity of the conditions and the cost of the capital equipment required to operate at these conditions. The direct route generally produces low-quality liquid products that are expensive to upgrade and do not easily fit current product quality constraints. Direct liquefaction will not be considered further here except in an historical context.

The reactions for indirect conversion of coal to fuels and chemicals are illustrated below and include:

**Combustion** to increase temperature and provide heat for the remaining reactions. Here, coal is represented by C-H, an approximate formula for many coals.

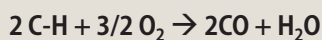

**Gasification** reactions include reaction of water with coal char and reaction between water and carbon monoxide.

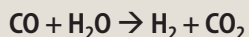
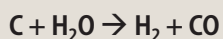

At typical gasification conditions, this syngas is an equilibrium mixture which is about 63% CO, 34% H<sub>2</sub> and 3% CO<sub>2</sub>, on a molecular basis

**Water gas shift** reaction is used to adjust the H<sub>2</sub> to CO ratio to the value required by the synthesis reaction to follow.

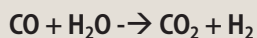

**Synthesis** reactions produce the desired products from the synthesis gas.

For **methane formation**, the synthesis gas needs to have a H<sub>2</sub> to CO ratio of 3 to 1.

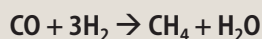

For **Fischer-Tropsch** reaction to form diesel fuel, the synthesis gas needs to have a H<sub>2</sub> to CO ratio of about 2 to 1.

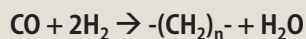

An ideal overall stoichiometry for the conversion of coal to methane can be illustrated by the following reaction, where coal is represented by C-H (a typical approximate composition of coal).

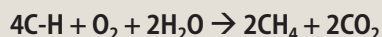

For Fischer-Tropsch (F-T) conversion to diesel fuel the ideal overall stoichiometry can be illustrated by:

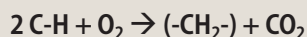

As these reactions show, under completely ideal conditions, one CO<sub>2</sub> molecule is produced for each CH<sub>4</sub> molecule produced and for each carbon atom incorporated into F-T product.

If coal is assumed to be pure carbon, then the overall reactions would be:

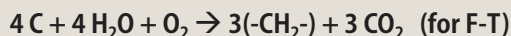

These reactions suggest that 1 2/3 CO<sub>2</sub> molecules are produced for every CH<sub>4</sub> molecule produced and one CO<sub>2</sub> molecule produced for each carbon atom incorporated into F-T product.

However, because of the need to heat the system to high temperatures, and because of process and system irreversibilities and other inefficiencies, the amount of CO<sub>2</sub> formed is significantly larger. Thus, synthetic fuels derived from coal will produce a total of 2.5 to 3.5 times the amount of CO<sub>2</sub> produced by burning conventional hydrocarbons. Since this study is concerned with understanding how coal is best utilized in a carbon constrained world, we must anticipate combining CCS with synfuels and chemicals production. Requiring CCS will make synfuels more expensive. On the other hand, CO<sub>2</sub> capture and separation is a required, integral part of the synfuels production process. It is also cheaper and easier because “indirect” synthetic fuels production uses oxygen rather than air, and the cost of the air separation unit (ASU), CO<sub>2</sub> separation, and high operating pressure are “sunk” costs of synfuels production process.

As an illustration, Figure A-3.F.1 presents a process flow diagram for the production of 50,000 bpd of Fischer-Tropsch liquids or the production of 15 million SCF/h of SNG from coal. Scale is an important issue in synfuels production because of the large size of our fuels consumption. A 50,000 bpd plant consumes over 5 times as much coal, and emits over 3 times as much CO<sub>2</sub> as does a 500 MW<sub>e</sub> IGCC plant. As noted above, the total fuel cycle

**Figure A-3.F.1 Process Flow Diagram for Coal-to-Fuels Production**

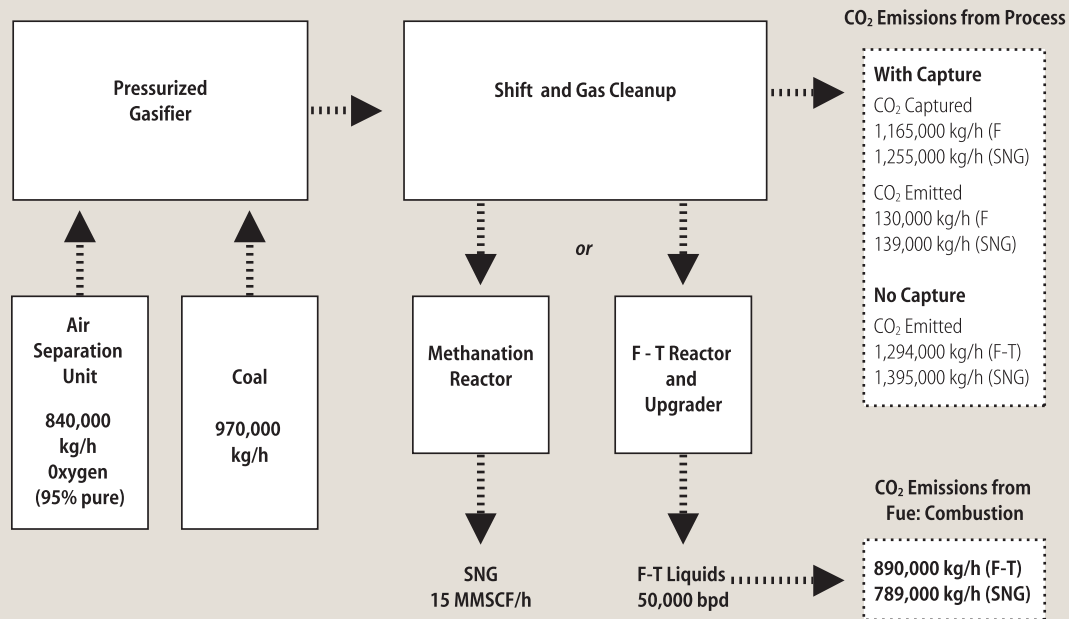

emission of CO<sub>2</sub> from the coal to fuels process is markedly larger than that for just burning the fuel if carbon capture and sequestration (CCS) are not employed. Without CCS, FT-synthesis of liquid fuels emits about 150% more CO<sub>2</sub> as compared with the use of crude oil derived products. For comparison, refining petroleum emits about 8 % more CO<sub>2</sub> than the amount that is emitted upon consuming the fuel. For SNG, up to 175% more CO<sub>2</sub> is emitted than if regular natural gas were burned [1]. With CCS, the full fuel-cycle CO<sub>2</sub> emissions for both liquid fuel and SNG can be comparable with the total CO<sub>2</sub> emissions from these fuels when derived from traditional sources. However for syngas, CCS does not require major changes to the process or significant energy penalties as is the case for electric power generation since the CO<sub>2</sub> is a process byproduct in an almost pure stream and at intermediate pressure.

### PRACTICAL EXPERIENCE WITH SYNFUELS

Technology to convert coal to liquid and gaseous fuels has been available in various forms since the 1920's, but the high capital and operating costs have kept it uncompetitive, except in situations of extreme shortage. SASOL, in South Africa, has been producing 195,000 barrels per day of liquid fuel using Fischer-Tropsch technology for several decades.

Today, the largest commodity chemical produced from syngas is ammonia. Most U.S. ammonia plants were designed to get their hydrogen for ammonia synthesis by reforming natural gas and shifting the resultant syngas mixture to pure hydrogen. Today, many of these plants are closed and/or exploring coal gasification as a source of syngas because of high natural gas prices [2]. World-wide there are a significant number of ammonia plants that use syngas from coal gasification. China (e.g., the Shenhua Group) is embarking on a number of large plants to convert coal to methanol, then to ethylene and propylene, for polyethylene and polypropylene production [3]. Dow is involved in one of these plants, where the plan is to sequester CO<sub>2</sub> [4].

Eastman Chemical in Kingsport Tennessee has operated a coal to chemicals plant for over 20 years, at 98% availability, without government assistance. The plant produces synthesis gas from coal (1,250 tons of coal/day fed to Chevron/Texaco gasifier) and then converts the synthesis gas to acetic anhydride and other acetyl chemicals. These routes to chemicals can be carried out individually or are easily integrated together. The possibility of production of liquid fuels and chemicals from coal raises an image of a coal refinery. Such a refinery, producing a slate of chemical and fuel products could also generate electricity as well. This is referred to as polygeneration.

In 1979, the United States, anticipating increases in the price of oil to \$100 per barrel, embarked on a major synthetic fuels program intended to produce up to 2 million barrels of oil equivalent per day of natural gas from coal and synthetic liquids from oil shale and coal. A quasi-independent government corporation, “The Synthetic Fuels Corporation” (SFC), was formed for this purpose. The SFC undertook to finance approximately six synfuels projects using a combination of indirect incentives, for example, loan guarantees and guaranteed purchase. The price of oil fell in the early 1980s to a level of about \$20 per barrel, making all coal to fuels technologies economically unattractive, and thus obviating the need for a government supported synfuels program, and the SFC was terminated in 1985. The lesson of the SFC is that it is dangerous to build a government support program on assumptions about future world oil prices.

## ECONOMICS OF COAL TO FUELS PRODUCTION

**CAPITAL COSTS** Several recent studies have evaluated the economics of both F-T synthesis fuels, and SNG production [5-8]. For F-T synthesis fuels, reported capital costs (TPC) range from \$42,000 to \$63,000 per bpd capacity, of which the F-T reactor section and associated equipment accounted for \$15,000 to \$35,000 of the costs. This compares to a typical capital cost of \$15,000 per bpd capacity for a traditional crude oil refinery. For SNG facilities, the reported capital cost for the methanation equipment range from \$22,000 to \$24,000 per million Btu/hr.

It is difficult to estimate the cost of synfuels plants; and historically, estimates have proven to be wildly optimistic. There are several reasons for this: First, few synfuels plants are in operation; and therefore, there are few data upon which to estimate the cost of a “first of a kind” or “N<sup>th</sup>” plant. Second, plant cost will vary with location, capacity, construction climate, product slate, and coal type. Third, there are differing economic assumptions about interest rates, equity/debt ratio, and capacity factor. Fourth, the engineering estimates are usually performed by development organizations that do not have the perspective of a plant owner and/or are frequently attempting to promote business opportunities. With these reservation about the uncertainties in cost estimates, we report the results of our analysis in Table A-3.F.1 [9], compiled using the same economic assumptions that were used in Chapter 3.

**Table A-3.F.1 Total Plant Cost for Synthetic Fuels Production Facilities\***

TECHNOLOGY	NO CO <sub>2</sub> CAPTURE	WITH CO <sub>2</sub> CAPTURE
F-T Synthesis (\$/bpd)	53,000	56,000
SNG Production (\$/MM SCF/h)	182,000	191,000

*\*Based on cost estimates made in the 2000 to 2004 period converted to 2005 \$ using CPI; recent increases in materials, engineering and construction costs will increase these significantly (of order 25%).*

We have also estimated the finished production costs for both coal to F-T fuels and coal to SNG, with and without CO<sub>2</sub> capture. To maintain consistency with the analysis of electricity generation in Chapter 3, we adopted a 20-year plant life, a three-year plant construction period and a 15.1% capital carrying charge factor on the total plant cost. We assumed 50% thermal efficiency for the F-T plant and 65% for the SNG plant [10]. Both plants were assumed to have a 95% capacity factor. The results of this analysis are shown in Table A-3.F.2.

Using the economic and operating parameters outlined above, the F-T fuel production cost is estimated at \$50/bbl without CCS and \$55/bbl with CCS. Approximately half of this cost is capital recovery charges due to the high plant cost. The CO<sub>2</sub> avoidance cost is \$9.6 per tonne for these conditions. The production cost of SNG is estimated to be \$6.7 /million Btu without CO<sub>2</sub> capture and \$7.5 /million Btu with CO<sub>2</sub> capture. The CO<sub>2</sub> avoided cost in this case is \$8.4 per tonne. The CO<sub>2</sub> avoidance cost is primarily due to the compression and drying costs (capital and O&M) of the CO<sub>2</sub>, which is already separated from the synthesis gas as an integral part of the fuel production process.

**Table A-3.F.2. Production Cost for Fischer-Tropsch Liquid Fuels and Synthetic Natural Gas**

COSTS	F-T PLANT, \$/bbl/day		SNG PLANT, \$/MM SCF/h	
	w/o CC	w/ CC	W/O CC	w/ CC
Total Plant Cost	53,000	56,000	173,000	182,000
	F-T LIQUIDS \$/bbl		SNG, \$/MM SCF	
Inv.Charge @ 15.1%	23.1	24.3	3.0	3.2
Fuel @ \$1.50/MM Btu	16.8	16.8	2.3	2.3
O&M	10.0	14.2	1.4	1.9
<b>Production Cost</b>	<b>49.9</b>	<b>55.3</b>	<b>6.7</b>	<b>7.5</b>
<b>CO<sub>2</sub> Avoidance Cost (\$/tonne CO<sub>2</sub>)</b>	<b>9.6</b>		<b>8.4</b>	

Today, the U.S. consumes about 13 million barrels per day of liquid transportation fuels. To replace 10% of this fuels consumption with liquids from coal would require over \$70 billion in capital investment and about 250 million tons of coal per year. This would effectively require a 25% increase in our current coal production which would come with its own set of challenges.

## SUMMARY COMMENTS

Under the economic assumptions of Table A-3.F.2, coal conversion to fuels becomes competitive when crude prices are greater than about \$45/bbl and when natural gas is greater than about \$7.00/million Btu.

Without CCS, such synfuels production would more than double CO<sub>2</sub> emissions per unit of fuel used because of the emissions from the coal conversion plant. CCS will increase the cost of coal-to-liquid fuels by about 10%. This relatively low additional cost is due to the fact that synthetic fuel plants are designed to use oxygen, operate at high pressure, and separate the CO<sub>2</sub> from the synthesis gas as an integral part of the fuels production process.

For IGCC plants designed to produce electricity, the production of fuels or chemicals (poly-generation) will usually be unattractive for a power producer. However, for synthesis gas plants designed to produce fuels and/or chemicals, power production for internal plant use (almost always) and for the merchant market (sometimes) will be attractive.

## CITATIONS AND NOTES

1. EIA, *EIA Voluntary Reporting of Greenhouse Gases Program (Emissions Coefficients)*. 2005c, EIA.
2. Wood, A., *Alternative Feedstocks; Warming Up to Coal*, in *Chemical Week*. March 30, 2006.
3. Shenhou, *Shenhou to Build Coal-to-Methanol Plant*, in *The Standard, China's Business Newspaper*. August 18, 2005.
4. Fryer, C., *The Renaissance of Coal-Based Chemicals: Acetylene, Coal-to-Liquids, Acetic Acid*, in *Tecnon OrbiChem Seminar at APIC*. 2006, Tecnon OrbiChem Ltd, UK: Bangkok, Thailand.
5. Bechtel, *Gasification Plant Cost and Performance Optimization, Final Report*. 2003, Global Energy, Nexant: San Francisco.
6. Gray, D., and Glen Tomlinson, *Coproduction of Ultra Clean Transportation Fuels, Hydrogen, and Electric Power from Coal*. 2001, Mitretek. [Report No. MTR2001-4]
7. Gray, D., *Polygeneration of SNG, Hydrogen, Power, and Carbon Dioxide*. 2004, Mitretek. [Report No. MTR-04-2004-18]
8. Bechtel, *Baseline Design/Economics for Advanced Fischer-Tropsch Technology*. 1998.
9. For this analysis, we assumed that the cost for the gasification process components were the same as for our IGCC analysis and the same for both F-T synthesis and SNG cases. We also assumed that the costs for the F-T and methanation portions of the plant were the mean of the values reported in the external design studies. For CO<sub>2</sub> capture cases, we estimated the cost of the CO<sub>2</sub> compression and dreying equipment from our IGCC data.
10. Gielen, D. and F. Unander, *Alternative Fuels: An Energy Technology Perspective*. 2005, IEA.

# Chapter 4 Appendices

## Appendix 4.A — Unconventional CO<sub>2</sub> Storage Targets

Chapter 4 focused on sequestration opportunities in saline formations and depleted hydrocarbon fields. What follows is a brief description of the opportunities and challenges associated with other potential geologic storage formations.

### **UNMINEABLE COAL SEAMS**

Definition of what coal is unmineable is limited by technological and economic constraints. For the purposes of this discussion, we will only consider seams deeper than 2500 feet (the deepest coal mine in the world today). The primary storage mechanism is well understood (gas adsorption) and serves as the basis for current volume assessments.<sup>1</sup> There is strong interest in this mechanism as it releases methane which might be profitably produced. This process, enhanced coal bed methane production, may offset the costs of capture and storage, increasing market penetration of sequestration and providing more flexibility in storage options.

Currently, many issues surround coal storage and ECBM. A major concern is that coals swell in the presence of CO<sub>2</sub>, which reduces their effective permeability and injectivity. In addition, many coal bodies have extremely low matrix permeability, and almost all flow is in the fractures (cleats) of the system. Cleat structures are extremely difficult to map, and their response to pressure transients from injection is poorly understood. In addition, coals plasticize and alter their physical properties in the presence of CO<sub>2</sub>, raising questions about long-term injectivity. From an effectiveness standpoint, it is unclear how to rank coals in terms of leakage risk; many targets underlie large permeable fresh water aquifers and could present a groundwater contamination and leakage risk. There was one large commercial CO<sub>2</sub>-ECMB pilot in northern New Mexico (the Allison Project)<sup>2</sup>; however, this project was deemed uneconomic by the operators and shut in 2004.

In short, these concerns limit the immediate attractiveness of unmineable coal seams for commercial CO<sub>2</sub> storage. However, many of these topics are the focus of intensive study throughout the world and might be partially resolved within a fairly short period of time.

### **BASALTS**

Basalts are crystalline and glassy rocks with abundant iron, calcium, and magnesium rich silicate minerals. When these minerals are exposed to carbonic acid over time, they prefer-

entially form new carbonate minerals, releasing silica but permanently binding CO<sub>2</sub>. In addition, large basaltic rock accumulations underlie locations where other geological storage options are scarce (e.g., the Deccan Traps, Japan). These features make basaltic rock bodies interesting potential targets.<sup>3</sup>

Many of the concerns present in coals are present in basalts. Their hydrology is notoriously difficult to constrain, and almost all the injectivity and transmissivity is related to fractures. This feature, however, raises several issues. It raises immediate questions of leakage risk. While there is evidence that some basaltic reservoirs are chemically segregated, there is no commercial database or industrial experience in predicting the sealing potential of fractured basalts or their response to injection pressure. The rates of the chemical reactions that bind CO<sub>2</sub> remain poorly defined, and prior studies of basaltic minerals estimated very slow kinetics for reactions.<sup>4</sup> Finally, there is no tested or established monitoring technology for basaltic formations, and due to the high velocity and low porosity of many basaltic units it is not clear if conventional seismic methods could detect a CO<sub>2</sub> plume or mineralization. Again, while many of these questions might be addressed through research, it appears that early commercial CO<sub>2</sub> storage in basaltic formation is unlikely.

## DIRECT MINERALIZATION

Similar to basaltic storage, carbonic acid will react with iron- and magnesium-rich silicate minerals to form carbonates, effectively binding the CO<sub>2</sub> permanently.<sup>5</sup> The kinetics for these reactions are extremely slow. However, one may engineer systems to accelerate reaction rates through increased acidity, elevated temperatures, and comminution of grains. These approaches suffer from high operational costs, and are currently not economic. However, they benefit from the sureness and permanence of CO<sub>2</sub> stored, and would require very little transport and monitoring. Continued research in this area may yet create new opportunities for storage.

## NOTES

1. Reeves, S., 2003, Assessment of CO<sub>2</sub> Sequestration and ECBM Potential of U.S. Coal Fields, Topical Report for the UC Dept. of Energy by Advanced Resources International, Report # DE-FC26-00NT40924
2. Reeves, S., Taillefert A., Pekot L., Clarkson, C., 2003, The Allison Unit CO<sub>2</sub>-ECBM Pilot: A Reservoir Modeling Study, DOE Topical Report, 2003
3. McGrail, P.B., et. al., 2006, Carbon Sequestration in Flood. Basalts, *J. Geophys. Res.*, Vol. 111, B12201od.
4. Carroll, S.A., Knauss, K.G., 2005, Dependence of Labradorite Dissolution Kinetics on CO<sub>2</sub>(aq), Al(aq), and Temperature, *Chemical Geology*, 217, 213-225.



## Appendix 4.B — Well Abandonment Practices Relevant to CO<sub>2</sub> Sequestration

CO<sub>2</sub> injected into any geological targets may encounter man-made well bores. For most sites of interest, CO<sub>2</sub> will form a supercritical fluid that is less dense than brine. If the rock above the formation is impermeable, it will physically trap the buoyant CO<sub>2</sub>, which will spread laterally in a plume. As long as the integrity of the cap rock is not compromised by permeable conduits like wells or faults, the cap rock will prevent the escape of mobile CO<sub>2</sub> phase. However, as a result of active hydrocarbon exploration and production during the last century, many of the sites under consideration for CCS projects may have wells that penetrate the cap rock. Wells that do penetrate the cap rock are potential sites through which mobile CO<sub>2</sub> phase might escape. Under typical circumstances, such wells would be properly cemented and plugged at depth, preventing upward migration of CO<sub>2</sub>. However, these wells may not have a proper plug in place to prevent the flow of CO<sub>2</sub> to the surface, and cement might fail either mechanically or due to corrosion.<sup>1,2</sup> If well integrity is compromised, it may act as a high-permeability conduit through which CO<sub>2</sub> could escape.

Recent research has shown that CO<sub>2</sub> could leak even from wells that are properly plugged. This occurs when carbonic acid forms due to dissolution of CO<sub>2</sub> into brines. When this acid comes in contact with hydrated cements, corrosion can occur.<sup>3</sup> The rate at which this degradation occurs depends primarily on temperature, but also on cement, brine, and rock composition. Currently, there is little chemical kinetic data or equations of state to use in modeling this problem.

The evolution of plugging techniques has been well documented in numerous oil and gas publications.<sup>4</sup> Most of the changes have occurred in plug lengths and additives that alter the properties of basic cement. While the modern objectives of plugging—protection of potable water source and the isolation of hydrocarbon zones—are the same in all states, minor details such as plugging material and plug length vary from state to state. To obtain detailed up-to-date plugging techniques and regulations, one should contact the Oil and Gas Divisions (or its equivalent agency) of each hydrocarbon producing state.

Cement was introduced to the petroleum industry as early as 1903,<sup>5</sup> and different techniques of cementing were soon patented in California but did not spread quickly to other states. As a result, many hydrocarbon states independently developed unique cementing techniques. Commonly, cement was used to bolster the production of hydrocarbons (i.e. cement lining, prevention of water flow into well), but was seldom used for plugging purposes. For example, in California, plugging with cement was not practiced until it became mandatory under the regulations of California Oil and Gas Division, established in 1915.<sup>6</sup> During this time, plugs were likely to be inadequate for prevention of CO<sub>2</sub> leakage from CCS projects—plugs discovered from the early days of hydrocarbon production include tree stumps, logs, animal carcasses, and mud. Even after many state regulatory bodies were established in the 30's and 40's, effective cement plugs were often not installed.<sup>4</sup> This lack of efficacy can be attributed to the fact that cement was poorly understood. Additives are chemical compounds that are added to basic cement components in order to tailor the cement to specific down-hole temperature and pressure conditions. Without these additives, basic cement often failed to harden and form an effective plug and the cement could become contaminated with the surrounding drilling mud. Most improvements in well cements developed between 1937 and 1950.<sup>4</sup> Notable differences in plugging procedures since 1953 are in plug lengths and the increase in the number of plugs in a single well<sup>7</sup> and are mainly the result of the Safe

Drinking Water Act of 1974.<sup>8</sup> The new standard technique, which is still the most common method of plugging used today, minimizes the mud contamination of cement.<sup>9</sup>

In the United States, the Safe Drinking Water Act of 1974 created the Underground Injection Control Program (UIC), requiring all underground injections to be authorized by permit and prohibiting certain types of injection that may present an imminent and substantial danger to public health.<sup>9</sup> The primary objective of UIC is to prevent the movement of contaminants into potential sources of drinking water due to injection activities. There are no federal requirements under UIC to track the migration of injected fluids within the injection zone or to the surface.<sup>10</sup> Under UIC, a state is permitted to assume primary responsibility for the implementation and enforcement of its underground injection control program upon the timely showing that the state program meets the requirements of EPA's UIC regulations.

A key regulation in the UIC program aimed to prevent leakages of injected fluids through wells is the Area of Review (AOR) requirement. Under this requirement, injection operators must survey the area around the proposed injection wells before any injection projects can commence. This area is determined through either an analytical method or a fixed radius method, usually a radius no less than a ¼ mile.<sup>11</sup> The radius used can vary among hydrocarbon producing states, as each state has a different approach for determining the appropriate area to be reviewed. Once the area has been determined, each operator must review the available well records that penetrate the injection zone within the AOR and plug all inadequately plugged wells.

Unowned and inactive wells subject to replugging are often termed *orphan wells*. Many orphan wells lie outside of the AOR for a given site, and these may become leakage pathways, as injected fluid can migrate outside of the anticipated area. Although states are generally not legally responsible for these orphan wells, they nevertheless frequently monitor them.<sup>5</sup> If significant leakage that endangers the environment or public health is detected from these wells, the state will use available funds to plug the well. Funds to plug these wells are often collected through production tax, fees, and other payments related to the oil and gas industry.

The main reason why states do not plug all of their orphan wells is due to the lack of available funds<sup>12</sup> and only those deemed highly hazardous are plugged immediately. State regulators have tried to alleviate the occurrence of these orphan wells by requiring well operators to demonstrate financial ability to plug wells before and during well operation.<sup>13</sup>

Unlike orphan wells, wells that were properly abandoned under the existing regulations at the time of plugging are not monitored by the state. These wells are termed *abandoned wells*. States are not mandated to monitor for leakage or other failures at these properly abandoned sites. The lack of monitoring is based on the assumption that once a well plug is set, the plug will not fail.<sup>4</sup>

Wells lacking a cement plug are most likely to be shallow wells that were drilled prior to 1930's. By 1930, many major hydrocarbon producing states had begun to monitor plugging operations. Thus wells abandoned after the 1930's are likely to have some form of a cement plug, although they may be of poor quality. Many wells were left unplugged after the 1986 oil bust as many companies became insolvent, and these deeper wells are of primary concern. Wells that were plugged with cement prior to 1952 may prevent CO<sub>2</sub> leakages

better than wells that were left unplugged or plugged with ad-hoc materials; however, their integrity cannot be assured and thus still remain to be major leakage sources. The cement plug deformation shows poor setting of the cement plug, which was corrected with the introduction of appropriate additives after 1952. Wells plugged after 1952 are the least likely to leak, due to modern methods and the due diligence required by regulation. However, the possibility of cement degradation by CO<sub>2</sub>-brine mixture remains.<sup>2</sup> It is important to note, however, that cement degradation has not been a serious issue in enhanced oil recovery activities with CO<sub>2</sub> flooding over the past 30 years.<sup>14</sup> There is little kinetic data on cement corrosion rates under a range of common conditions of pressure, temperature, and brine-rock composition. As such, it could take tens to thousands of years for CO<sub>2</sub> to corrode enough cement to reach the surface. In addition, it is not clear that even substantial degradation of the cement or casing would result in large volume escape of CO<sub>2</sub>. More laboratory and field research is needed to understand and quantify these effects for both scientific and regulatory purposes.

To reduce these risks, a revision of existing regulations may be needed to address liability issues that could arise due to surface leakage. Revisions should address issues such as how abandoned wells should be assessed before and after CO<sub>2</sub> injection, how CO<sub>2</sub> concentrations might be monitored at the surface, the process of designating a responsible party for a long-term monitoring of abandoned injection sites, and how to allocate funds to replug high-risk wells.

Lastly, CO<sub>2</sub> sequestered underground could surpass the ¼ to ½ mile radius that is typically used to assess the wells in the area around and injection well. As the AOR increases for sequestration projects, the number of wells that fall within this area may increase significantly. In order to ensure proper injection-site integrity, it may be necessary to alter regulations to cover the likely footprint for injection. Regulators may need to concern themselves with the determination of the CO<sub>2</sub> injection footprint, the requirements for operators to treat abandoned and orphan wells, and the liability associated with leakage within and without the predetermined footprint.

## NOTES

1. Scherer, G.W., M.A. Celia, J.H. Prevost, S. Bachu, R. Bruant, A. Duguid, R. Fuller, S.E. Gasda, M. Radonjic, and W. Vichit-Vadakan, "Leakage of CO<sub>2</sub> through Abandoned Wells: Role of Corrosion of Cement," in *The CO<sub>2</sub> Capture and Storage Project* (CCP, Volume II, D.C. Thomas and S.M. Benson (Eds.), 823-844, 2005).
2. Gasda, S.E., Bachu, S., Celia, M.A., 2004, The Potential for CO<sub>2</sub> Leakage from Storage Sites in Geological Media: Analysis of Well Distribution in Mature Sedimentary Basins, *Environmental Geology*, 46, 707-720.
3. Duguid, A., Radonjic, M., Scherer, G.W., 2006, The Effect of Carbonated Brine on the Interface Between Well Cement and Geologic Formations Under Diffusion-controlled Conditions, 8th International Conference on Greenhouse Gas Control.
4. Jarrell, P.M., C.E. Fox, M.H. Stein, S.L. Webb, *Practical Aspects of CO<sub>2</sub> Flooding*. Monograph 22. Society of Petroleum Engineers, Richardson, TX, USA., 2002
5. Dwight Smith, *Cementing* (Dallas: Millet the Printer Inc., 1976), 1.
6. Jim Campion (California Oil and Gas Division), letter to author, 17 August 2005.
7. Ramon Fernandez (Texas Central Records), personal communication, 12 July 2005.
8. Safe Drinking Water Act provisions on underground injection are available at 42 U.S.C. § 300h *et seq.* (2005) and UIC provisions are available at 40 C.F.R. § 144 *et seq.* (2005).
9. Hussain Rabia, *Oil Well Drilling Engineering, Principles and Practice* (Maryland: Graham & Trotman Inc., 1986), 270.

10. Wilson E., Johnson T., Ketih D., 2003, Regulating the Ultimate Sink: Managing the Risks of Geologic CO<sub>2</sub> Storage, *Envtl. Sci. Tech.*, 37, 3476-3483).
11. United States Environmental Protection Agency, *Guidance Document for the Area of Review Requirement*, 1985 (Norman: USEPA. 1985), 9.
12. Williams, *Texas Plugging Primer*, 2, 9.
13. United States Environmental Protection Agency, *Federal Financial Responsibility Demonstration for Owners and Operators of Class II Oil and Gas Related Injection Wells*, 1990 (Washington, DC: USEPA. 1990), 2-13.
14. Stephen Guillot (Kinder Morgan), letter to author, 8 August 2005.

## Appendix 4.C — Description and Cost Assumptions for CO<sub>2</sub> Storage Projects

In considering large CO<sub>2</sub> storage experiments, the first concerns must be injectivity, capacity, and effectiveness. In planning a set of experiments for a country or the world, the next consideration must be to accurately reflect the richness of the key geological settings for successful large-scale deployment. To consider the global context of commercial deployment, the variance should include the following aspects:

- Critical plays defined by density of coal-fired power generation and other large point sources.
- A range of reservoir character (homogeneous and heterogeneous, Siliciclastic and carbonate, high- and low-injectivity)
- A range of physical seals (mudstones, evaporites)
- A range of potential leakage mechanisms (faults, wells)

Thankfully, it is not necessary to test the entire matrix of possible parameters suggested by this list. The most important and representative cases can be represented by a handful of geological settings, and the number of critical plays is not enormous even on a global basis.<sup>1</sup> Nonetheless, to represent a large-scale deployment accurately, an experimental project must be large itself.

To estimate the likely costs of a large-scale experiment, the following assumptions were used:

1. No CO<sub>2</sub> capture is needed: the available experimental source is a pure supply and sold at prices comparable to CO<sub>2</sub>-EOR commodity prices.
2. Annual injection volumes would range from 500,000 to 1 million tons CO<sub>2</sub>
3. The project would run for 8 years, with two years of scoping and preparation, five years of injection and 1 year post mortem
4. The project would proceed on land
5. There is no consideration of capital depreciation or discount rate

With this basis, Table A-4.C.1 lays out the range of estimated costs for various stages of a broad experimental program.

These assumptions, conditions, and estimated costs are not unreasonable. The incremental costs of the Sleipner program are comparable to the above projections.<sup>2</sup> In this context and in 1996 dollars, the comparable costs total to 152 million. The costs of well and monitoring are higher for the Sleipner case, but these costs did not include a broad monitoring suite, an aggressive science program, or post-injection validation.

**Table A-4.C.1 Estimated Costs of a Large-Scale CO<sub>2</sub> Injection Experiment**

PROGRAM ELEMENT	EST. COST (\$M)
Detailed pre-drill assessment	\$2 - 4
Wells, injection (1-2) and monitoring (3-8)	\$3 - 8
CO <sub>2</sub> (5 years injection)	\$1.5 - 10 / yr
Compression (5 years)	\$3 - 6 / yr
Monitoring (5 years)	\$.2 - 6.4 / yr
Analysis and simulation	\$5 - 7
Post injection sampling and re-completion	\$3 - 8
Total Sum	\$107 - 255
Average Annual Sum	\$13 - 28

## NOTES

1. Friedmann, S.J., 2006, *The Scientific Case for Large CO<sub>2</sub> Storage Projects Worldwide: Where They Should Go, What They Should Look Like, and How Much They Should Cost*, 8th Greenhouse Gas Technology Conference, Trondheim, Norway, Poster session II
2. Torp, TA and Brown, KR, 2004, CO<sub>2</sub> underground storage costs as experienced at Sleipner and Weyburn, GHGT-7

# Appendix 5.A — India

## INTRODUCTION

India is the world's second most populated country, after China, with 1.1 billion people.<sup>1</sup> With its higher population growth rate, India is projected to equal China's predicted population of 1.45 billion people in 2030. India's economy, with a real growth rate of 7.8%, lags that of China, which has a real growth rate of 9.2%.<sup>2</sup> India also lags China in terms of electricity consumption with an average per capita consumption of 600 kW<sub>e</sub>-h/yr, compared with China's 1700 kW<sub>e</sub>-h/yr and about 14,000 kW<sub>e</sub>-h/yr in the U.S..<sup>3</sup> India is also plagued by chronic electricity shortages. To address these problems, India has put in place policies to speed up generating capacity additions and growth in the power sector. The Indian central government plays a large role in electric sector development, presenting an opportunity for an effective single source of leadership. All factors suggest significantly increased coal consumption

## POWER GENERATION

**BACKGROUND** Until recently, India maintained a relatively closed economy and focused on indigenous or indigenized technologies. In the electricity sector the key players were the National Thermal Power Corporation (NTPC), the central government's power generation company, and Bharat Heavy Electricals Limited (BHEL), the primary boiler and steam turbine manufacturer and turn-key plant constructor. The central government owned nuclear and hydroelectric plants and large thermal plants (NTPC) that supplied substantial electricity across state boundaries. The remainder of the Indian electricity sector was historically under the control of vertically-integrated State Electricity Boards (SEBs) which built, owned and operated the local electricity infrastructure (generation and distribution), and set rates and collected tariffs. In an effort to promote food production and increase the rate of agricultural growth in the late 1970's, farmers were given free electricity for irrigation. The state-controlled SEBs used this and other related programs as a political instrument whereby the state governments could introduce subsidies for political gain. As a result of this and the lack of effective control over illegal connections to the grid, by the mid-1990s about 30% of the electricity produced was un-metered or not paid for. Even for the metered portion low tariffs were set for many poorer consumers and largely cross-subsidized by higher tariffs charged to commercial and industrial users. The gross subsidy per unit of electricity generated increased from 0.75 Rupees/kW<sub>e</sub>-h (2 ¢/kW<sub>e</sub>-h) in 1997 to 1.27 Rupees/kW<sub>e</sub>-h (2.6 ¢/kW<sub>e</sub>-h) in 2002.

The result was that many SEBs were effectively bankrupt, deeply indebted to the central government financing institution, and unable to honor payments to generators or to fi-

nance new capacity. This has been a primary root-cause of depressed growth in new generating capacity additions over the last 15 years and the resulting power shortages. Today, the unmet electricity demand is 7.6%, and the peak demand deficit is 10%.<sup>4</sup> This does not take into account the fact that 40% of Indian households are not yet electrified or connected to the grid and rely primarily on biomass for their energy needs.<sup>5</sup>

In the mid-90s the Indian economy began to be opened up. To address the increasing electricity shortages the Indian government encouraged independent power production (IPPs). However, because of the poor financial state of the SEBs and their inability to pay for power purchased, most IPPs either failed or never materialized.

**Figure A-5.1 Electricity Generation** (*share of annual kW<sub>e</sub>-h*)

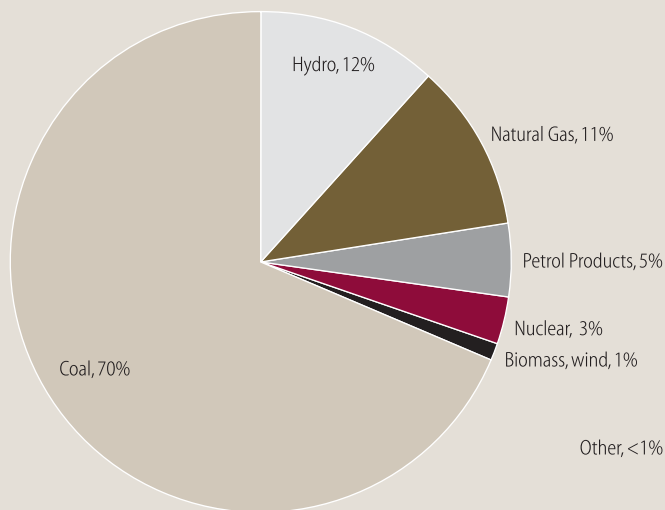

IEA data from 2003

**TODAY** India's installed generating capacity in the public or utility sector was 115,550 MW<sub>e</sub> in 2005.<sup>4</sup> Of this, coal generating capacity was 67,200 MW<sub>e</sub> or 58% of total installed capacity. These plants accounted for almost 70% of India's electricity generation (Figure A-5.1). India's coal consumption was about 360 million tons in 2000 and increased to 460 million tons per annum in 2005 or an increase of about 5.5%/yr. Recently, total electricity generating capacity growth has averaged about 3.3% per year, whereas the economy has been growing at over twice that rate; thus, the increasingly severe electricity shortages.

In addition to the public or utility generating capacity, Indian companies have resorted to captive power to ensure the availability of consistent, quality power. Captive power generation is within-the-fence generation that provides the primary power needs of the facility and is not connected to the local grid.

Indian captive power grew from 8.6 GW<sub>e</sub> installed capacity in 1991 to 18.7 GW<sub>e</sub> installed capacity in 2004.<sup>6,7</sup> At this level it represents almost 25% of the public or utility thermal generating capacity in India. The fuel mix for captive power is about 45% coal, 40% diesel and 15% gas.

The Indian government, recognizing the problems inhibiting growth, began addressing them through policy reforms in the 1990s, culminating in the Electricity Act of 2003. This legislation mandated the establishment of electricity regulatory commissions at the state and central levels, and the development of a National Electricity Policy. Emphasis was placed on financial reforms and on unbundling the SEBs into separate generating, transmission, and distribution companies. To date, eight of 28 states have unbundled.<sup>8</sup> The legislation opened the electricity sector to private generating and private distribution companies, gave increased flexibility to captive power generators, and gave open access to the grid.

The ability to meet electricity demand and to increase electricity supply will depend on the success of structural, financial, and economic reforms in the power sector. The payment structure to generators was reformed to create incentives for generating companies to improve plant efficiencies and to increase operating load factors. This, combined with the restructuring of the SEBs, had the purpose of improving the financial health of the sector to



ensure payments to the generating companies and improve payment collection from consumers. This would attract more private sector development, particularly by IPPs.

During the 1990s the central sector, particularly NTPC, began to play a larger role. It developed an engineering center that successfully improved plant operating factors and efficiency and began to offer engineering services to the SEB-operated plants. These activities helped improve plant performance and during this period the all-India average plant operating load factor increased from 64% in 1997 to almost 75% in 2005. This load factor improvement has been responsible for about half of the power generation growth that India achieved during this period. Economic incentives to improve plant efficiency are sufficiently recent that the all-India effect is still small. Operating efficiency improvements are harder to achieve than improvements in plant load factor.

The Electricity Act of 2003 mandated the development of a National Electricity Policy and a Plan for achieving it. These were developed by mid-2005. The National Electricity Policy calls for (a) eliminating general and peak shortages by 2012 so that demand is fully met, (b) achieving a per capita electricity consumption increase to over 1000 kW<sub>e</sub>-h by 2012, (c) providing access to electricity for all households, (d) strengthening the national grid and distribution systems, and (e) metering and appropriately charging for all electricity generated.

The Plan for achieving these goals calls for doubling installed generating capacity from 100,000 MW<sub>e</sub> in 2002 to 200,000 MW<sub>e</sub> by 2012. The goal is to meet all demand and create a spinning reserve of at least 5%. The Planning Commission's Expert Committee on Integrated Energy Policy has recommended an energy growth rate of 8%/yr to ensure continuing economic development. This would require that installed capacity increase from 115 GW<sub>e</sub> in 2005 to 780 GW<sub>e</sub> in 2030 and that coal consumption increase from 460 million tons/yr in 2005 to about 2,000 million tons/yr in 2030.<sup>9</sup> The Plan also calls for: (a) gas-based generation to be sited near major load centers, (b) new coal plants to be sited either at the pit-head of open-cast mines or at major port locations which can easily import coal, (c) thermal plant size to be increased to the 800-1000 MW<sub>e</sub> size and (d) a shift to supercritical generating technology.

India's new capacity additions are primarily the joint responsibility of the central and state sectors, and to a lesser degree, the private sector. The process of capacity addition begins with the Central Electricity Agency (CEA), which collects and analyzes historical and annual operating data, makes forward projections of demand (both national and local) and develops recommendations of new capacity additions including fuel mix, size, and location of plants to meet these needs. These recommendations form the basis for discussions among the various players of how to meet the increased demand.

It is clear that NTPC is playing a larger role than it has in the past because it has met its capacity addition commitments and improved plant performance effectively, whereas the SEBs have routinely fallen far short of meeting their capacity addition commitments and have frequently had the lowest operating efficiency plants in the system. The worst of these plants have been handed over to NTPC to operate. Currently over 90 % of the installed coal capacity in India is under 250 MW<sub>e</sub> per unit, and all units are subcritical. NTPC has built and operates most of the 500 MW<sub>e</sub> plants in India. NTPC currently has an effective in-house technology capability which it is further strengthening, and it is greatly expanding its technology center. It has the lead on the introduction of supercritical generating technology into India and has the financial resources to build 800–1000 MW<sub>e</sub> plants. It currently owns and operates about 32% of installed coal capacity,<sup>10</sup> but is destined to play a larger role in the future.

Our assessment of the Electrification Plan is that it adequately addresses the most important problems in the Indian electricity sector. However, the most critical question is, “Can it be successfully implemented?” This is more problematic, in that the Indian bureaucracy offers many roadblocks. Coal supply is one of the most important issues, and the rate of coal industry reform will be critical. Coal India Limited (CIL) may be able to produce only about 1/3 of the projected 2030 coal demand; the rest would have to be imported.<sup>9,11</sup>

The view from the state of Andhra Pradesh (AP) offers some insight into these issues. AP unbundled its SEB about two years ago and is well into the new structure. Our discussions with the AP Environmental Protection Department, the AP Electricity Regulatory Commission, the AP GenCo, and the AP distribution company all provided a consistent understanding of the National Electrification Plan and how AP was addressing it. Such a high level of alignment is encouraging. CIL did not show high alignment.

AP is involved in planning a couple of large generating plants, one potentially at mine mouth and one in the port city of Chennai. Negotiations are between APGenCo and NTPC. The distribution company has reduced the extent of un-metered electricity to about 20% (confirmed by the AP Electricity Commission) and has plans to further reduce it. They are installing meters at a rapid pace with the target of being fully metered by 2012. AP also has a couple of IPPs which are being paid for all the electricity they produce. In a state with a SEB in worse financial shape, the story would not be as positive.

## **COAL-GENERATING TECHNOLOGY AND CO<sub>2</sub>**

As already noted, India’s PC power generation sector employs only subcritical technology. Coal is India’s largest indigenous fuel resource, and it has a reserves-to-production ratio of about 230 years at today’s production level. To use this resource most wisely and to reduce CO<sub>2</sub> emissions, higher generating efficiency technology is important. NTPC is now constructing the first supercritical pulverized coal power plant in India and has plans for several additional units. The technology is being supplied by a foreign equipment manufacturer. To remain competitive the national equipment manufacturer, BHEL, has entered into an agreement to license supercritical technology from a different international equipment manufacturer. This competition should serve to reduce the costs and make it more feasible politically for Indian generating companies to build supercritical plants in the future. Ultimately, by constructing only supercritical PC power plants, CO<sub>2</sub> emissions could be reduced by one billion tons between 2005 to 2025 based on projected capacity adds.<sup>12</sup>

Integrated gasification combined cycle (IGCC) technology is a more distant option that requires development for India’s high-ash coal. NTPC, in coordination with the Ministry of Power India, is planning to build a 100 MW<sub>e</sub> demonstration plant either with a foreign technology or with BHEL-developed technology. One issue is that the more-proven foreign entrained-bed gasifier technology is not optimum for high-ash Indian coal. BHEL’s fluid-bed gasifier is better suited to handle high-ash Indian coal but needs further development. BHEL has a 6 MW pilot plant which it has used for research. This represents an opportunity to develop a gasifier applicable to high ash coals that adds to the range of IGCC gasifier technology options.

## CONCLUSION

India's economic development lags that of China, and its power development lags even further. However, India's economic growth is likely to continue and further accelerate over time. This will require rapid growth in electricity generation, and a large fraction of this will be coal-based. Growth in coal-based power generation is indicated by central government and NTPC plans for and recent governmental approval of 11 coal-based IPP power plants to be built by industry leaders such as Reliance Energy and Tata Power, with a total capacity of 42,000 MW.<sup>13</sup> The fact that rapid growth is just beginning in India offers opportunities in that there is time to institutionalize cleaner, more efficient generating technologies before the greatest growth in the Indian power sector occurs.

The central sector company (NTPC) has successfully met its expanded capacity addition targets, has opened a power plant efficiency center, developed technology capabilities to improve plant operating factor and efficiency, is pursuing IGCC technology, and is markedly expanding its research and technology center capabilities. The strength and breadth of these activities suggest the potential for an Indian power generation sector company to develop and disseminate technology, create generating standards and practices, and be a factor in the rational development and deployment of the needed generating capacity.

## CITATIONS AND NOTES

1. Population Division of the Department of Economic and Social Affairs of the United Nations Secretariat, *World Population Prospects: The 2004 Revision and World Urbanization Prospects: The 2003 Revision*, <http://esa.un.org/unpp>, 12 February 2006.
2. "The World Factbook." CIA. <09 February 2006> Online: [www.cia.gov](http://www.cia.gov). GDP per capita is \$3400 in India and \$6200 in China in 2005 at purchasing power parity.
3. BP statistical review full report workbook 2005. Based on gross output. Population based on July 2005 data from CIA World Factbook. [www.cia.gov](http://www.cia.gov)
4. Ministry of Power, Government of India. Installed capacity of power stations on 31.12.2005. [http://powermin.nic.in/JSP\\_SERVLETS/internal.jsp](http://powermin.nic.in/JSP_SERVLETS/internal.jsp)
5. Dickel, Ralf. Head, Energy Diversification Division, International Energy Agency. "Coal and Electricity Supply Industries in India: Key Issues". Conference on Coal and Electricity in India, New Delhi, India. 22 September 2003
6. Shukla, P.R. et al., "Electricity Reforms in India," Tata McGraw Hill. 2004.
7. Central Electricity Authority (CEA), Ministry of Power, Government of India, "Public Electricity Supply — All India Statistics," General Review 2005, New Delhi, India, 2005s.
8. "Power Sector Reforms". Ministry of Power, Government of India. [http://powermin.nic.in/indian\\_electricity\\_scenario/reforms\\_introduction.htm](http://powermin.nic.in/indian_electricity_scenario/reforms_introduction.htm). Accessed 13 February 2006.
9. "Draft Report of the Expert Committee on Integrated Energy Policy". Planning Commission, Government of India. New Delhi, December 2005. <http://planningcommission.nic.in/reports/genrep/intengpol.pdf>
10. Ministry of Power, Government of India. Installed capacity of power stations on 31.12.2005. [http://powermin.nic.in/generation/generation\\_state\\_wise.htm](http://powermin.nic.in/generation/generation_state_wise.htm)
11. "Dark Clouds over Coal Output," Hindustan Times, HT2, Page 1, January 17, 2007.
12. Emissions forecasts from IEA.
13. Hindustan Times paper, Sept 21, 2006, HT2, page 3



## Appendix 8.A — Government Assistance to IGCC Plants Without Capture

Because of the current interest in gasification technology for coal electricity generation and the prominence given to gasification technology in the 2005 Energy Act, we discuss the factors that federal or state policy makers should consider in deciding if incentives should be offered for projects to build IGCC *without* CO<sub>2</sub> capture.

To recap the discussion in chapter 3 of our report, our assessment is that there is sufficient practical experience with IGCC *without* capture so that technical readiness should not be used as a justification for governmental support. Since a new IGCC plant is likely to operate as designed (after a start-up period) additional IGCC “demonstration” plants without CCS are not needed. The reason that new IGCC electricity generating plants are not being ordered today, in the absence of a subsidy and/or favorable regulatory treatment, is because of the cost difference reported in Chapter 3 between IGCC and SCPC in the absence of a carbon charge, together with the vastly greater experience base for operating PC power plants reliably.

Our base line estimate of the cost of electricity is that SCPC is today and for the foreseeable future cheaper than IGCC for plants without capture. We also estimate that the cost to retrofit an IGCC plant for capture is less than the cost to retrofit a comparable SCPC plant for capture. These conclusions are based on point estimates with a number of operating and economic assumptions, e.g. capacity factor, discount rate, investment cost, etc. We have not performed sensitivity analysis although this evidently would be helpful in defining the range of possible outcomes.

Two arguments are advanced for government assistance for building IGCC plants without capture in addition to technical readiness. The first argument is that IGCC is more flexible for adapting to possible new federal regulations. This is true for CO<sub>2</sub> capture under our base line estimate with presently available technology and may be true for future regulations of criteria pollutants or mercury capture. The argument here is that there is a public interest to encourage investment today in the technology that is judged to be more flexible for responding to tighter emissions restrictions that may be applied at some uncertain future date. The second argument is that the public will be better off if the new power plants that are built are IGCC plants because these plants are cheaper to retrofit and thus the adjustment to a possible imposed carbon charge in the future will be less costly compared to a PC plant.

Our analysis of these arguments depends upon the nature of market regulation.

**In an unregulated market** private investors will make their decision to build IGCC or SCPC based on their evaluation of many uncertain variables that affect the future profitability of their investments: these variables include the future trajectory of electricity prices, the cost and performance of alternative generating technologies, and the evolution and cost of complying with future environmental regulations, including the magnitude and timing of a carbon charge. We see no reason to interfere in this decentralized investment evaluation process and believe that the decisions of private investors are as good a way to deal with future uncertainty as any government guesses about the relevant variables. If the government wishes to influence the decision of the private investors toward taking the need for CCS into account, the proper way to do so is to adopt an explicit policy of carbon constraints, not to offer subsidies to IGCC technology without capture. The subsidy would permit the private investor to capture the increase in market electricity price that will accompany a future carbon charge without paying anything for this benefit or taking any risk.

**In a regulated, cost of service, market** the situation is different. A state utility regulatory body might decide that it is desirable to encourage new IGCC power plants even though they are more expensive to build, because of an anticipated imposition of a carbon charge. Because the regulatory body determines the return to the utility investor, if the carbon charge is imposed, the future rate of return for the utility can be adjusted so, in principle, there is no windfall for the investor. So in a state where there is regulated cost of service generation, incentives arising from the willingness of state regulators to approve construction and costs recovery for IGCC without capture today is a plausible regulatory response to uncertainties about future environmental policies. Indeed, in a regulated environment, cost-based regulation may undermine private investor incentives to evaluate properly the future costs and benefits of investments in alternative generating technologies. Of course, this assumes that the state PUC's reasoning is indeed based on consideration of adapting to possible future CO<sub>2</sub> emission regulation and not other extraneous factors such as creating a concealed subsidy for coal mined in the state.

There remains, however, a policy problem that is only now becoming recognized. Prospective investors in new SCPC or IGCC plants today may believe as a practical political matter, that they will be "grandfathered" from any future CO<sub>2</sub> emission restrictions, either partially or totally for their remaining life, by tax abatement or by the allocation to them of free CO<sub>2</sub> emission rights in the context of a cap and trade program. If true, grandfathering would, at the very least, insulate private investors from the future costs of CO<sub>2</sub> charges, leading them to ignore these potential future costs in their investment assessments. This would create a bias toward SCPC plants relative to IGCC. At the extreme it might lead investors to build plants, especially SCPC plants, early in order to avoid the consequences of the possible imposition of a carbon charge.

What can the government do to avoid this perverse incentive? The correct measure is to pass a law or adopt a regulation today that makes it clear that **new coal plants** will **not** be shielded from future emission constraints through tax abatements, free allocations of emissions permits, or other means. Some might argue that absent the adoption of a "no grandfathering rule" there is need for a compensating second best policy of providing subsidies for building IGCC plants without capture – on the premise that if emission rights have sufficient value the IGCC's will retrofit CCS and a desired level of emissions will be achieved at lower cost.

We believe it important for the federal government to take some policy action to deter early investments in coal-burning plants based on the expectation that these plants will be “grandfathered” to one degree or another in the future. We are unconvinced that a subsidy for IGCC plants is an acceptable second-best choice; since in order to be reasonable it would anyway require a “no-grandfathering” rule for those plants that did receive assistance. The correct choice is to apply the “no grandfathering” rule to all new power plants, regardless of fuel or technology choice. Moreover, the possibility exists, as described in Chapter 3, that R&D will result in another technology cheaper than IGCC for CO<sub>2</sub> CCS; for example a cheaper way of producing oxygen could reverse the retrofit advantage of IGCC over SCPC.



Massachusetts Institute of Technology

ISBN 13: 978-0-615-14092-6

psb 06-04-0285